

TOSHIBA

—
EXPERIENCE
THE FUTURE
—



TOSHIBA AIR CONDITIONING > CATALOGUE 2021

Not all models shown are available in UK and ROI

 *Better Air Solutions*



QUALITY RELIABILITY ENVIRONMENT PROFITABILITY SIMPLICITY QUALITY

EXPERIENCE THE FUTURE

> “Toshiba solutions
wherever you are”

In 1961, Toshiba presented the first split air conditioning unit to the world – a system where the indoor and outdoor units are only connected by copper piping. Today, more than 50 years later, Toshiba still offers a wide range of top-quality products and services utilizing the best technologies.

RELIABILITY ENVIRONMENT PROFITABILITY SIMPLICITY QUALITY



> THE ESSENCE OF TOSHIBA

> Basic Commitment of the Toshiba Group

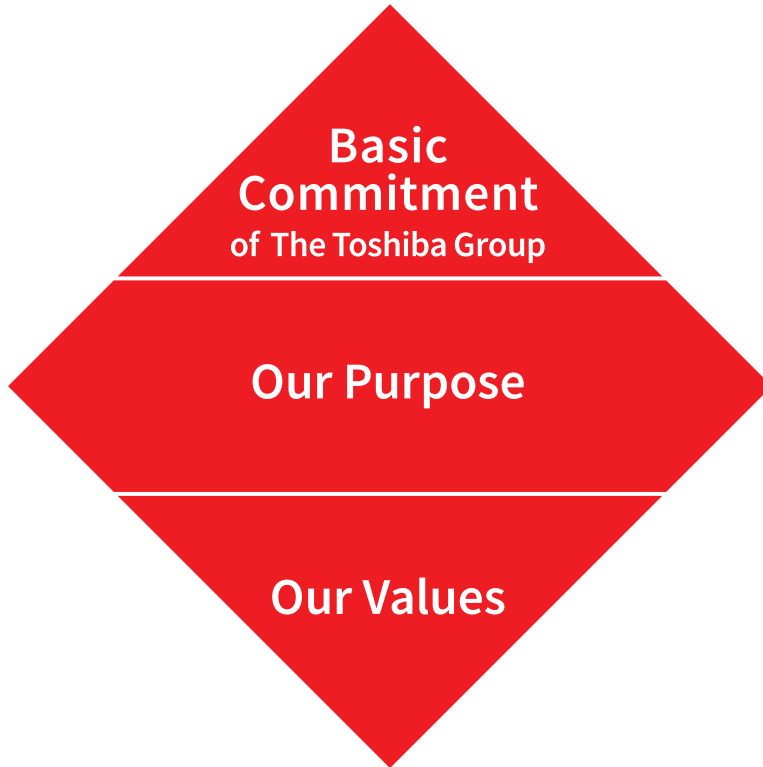

Committed to **People**,
Committed to the **Future**

At Toshiba, we commit to raising the quality of life for people around the world, ensuring progress that is in harmony with our planet.

> ALWAYS ONE STEP AHEAD

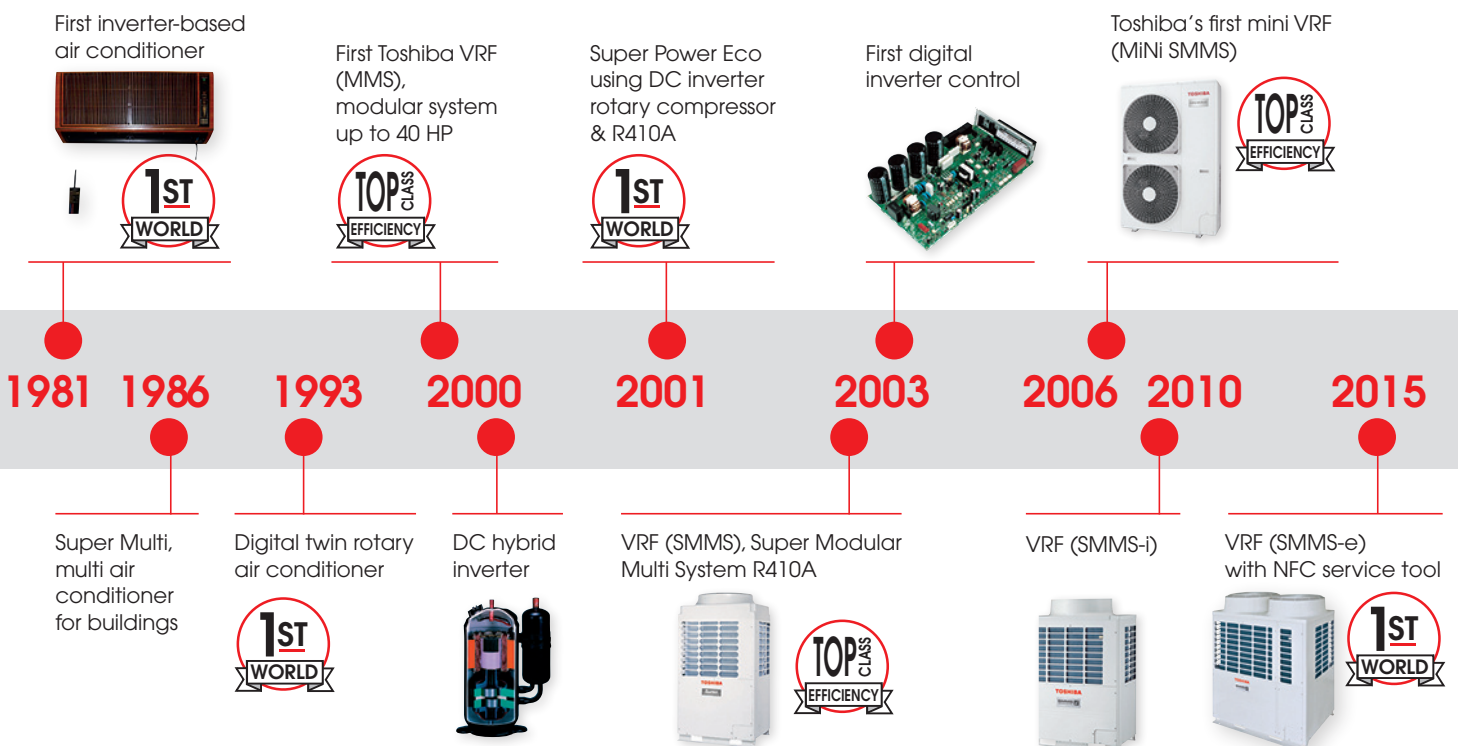

> Our Purpose

We are Toshiba. We have an unwavering drive to make and do things that lead to a better world.

A planet that's safer and cleaner. A society that's both sustainable and dynamic. A life as comfortable as it is exciting. That's the future we believe. We see its possibilities, and work every day to deliver answers that will bring on a brilliant new day.

By combining the power of invention with our expertise and desire for a better world, we imagine things that have never been – and make them a reality.

That is our potential. Working together, we inspire a belief in each other and our customers that no challenge is too great, and there's no promise we can't fulfill.

We turn on the promise of a new day.

> Our Values

Do the right thing

We act with integrity, honesty and openness, doing what's right - not what's easy.

Look for a better way

We continually strive to find new and better ways, embracing change as a means of progress.

Always consider the impact

We think about how what we do will change the world for the better, both today and for generations to come.

Create together

We collaborate with each other and our customers, so that we can grow together.

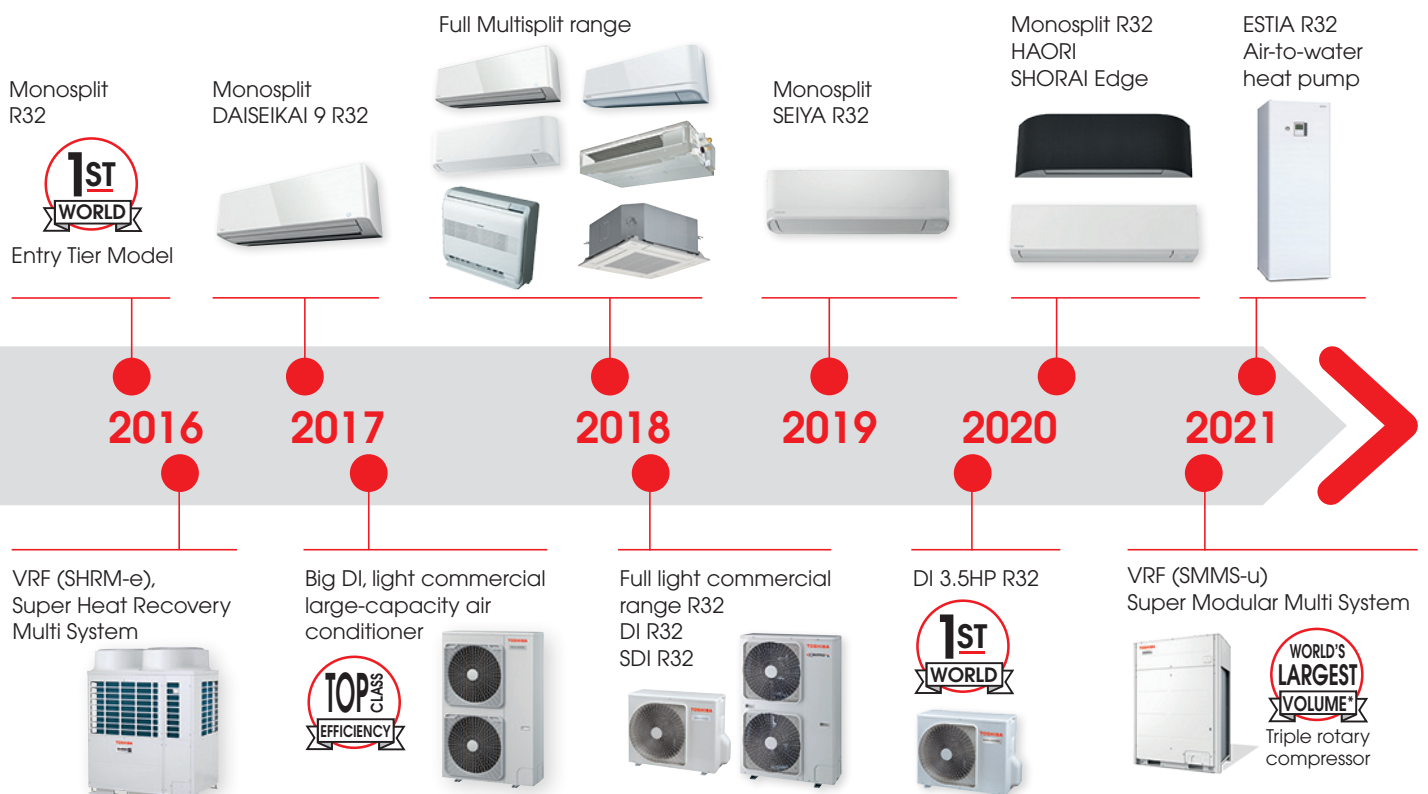

* (as of Dec. 2020)

> TOSHIBA AIR CONDITIONING VISION



Better Air Solutions

> CHOOSE THE EXPERT OF INSPIRED TECHNOLOGIES

Toshiba Air Conditioning's philosophy is based on profound respect for our global environment and the desire to improve our customers' quality of life worldwide.

In 1981, Toshiba developed the inverter technology for residential air conditioners which is nowadays employed by most air conditioning leading brands.

Inverter enables the unit to continuously regulate its cooling and heating capacity by altering the speed of the compressor using a variable-frequency drive to control the speed of the motor. This innovation ensures outstanding comfort and efficiency levels.

World's 1st
1981



Inverter
Driven
Compressor



World's 1st
1988



Twin Rotary
Residential
Use



World's 1st
1993



DC
Twin Rotary



World's 1st
1998



R410A
Residential
Use



World's 1st
2004



Dual Stage
Compressor



World's Largest
Volume*
2020



Triple Rotary
Compressor



* (as of Dec. 2020)

Our commitment to world-class **efficiency**, versatile **scalability** and leading **quality** means we create cutting-edge technologies to find the most forward-thinking solutions possible for your world. Toshiba Air Conditioning is an innovative provider of comprehensive air conditioning solutions with world-class reliability.

> Top-class energy efficiency

- The world's largest Triple rotary compressor ⁽¹⁾
- Twin rotary compressors
- All climates from -30°C (Daiseikai 9) to 54°C (MiNi SMMS-e Middle East range)
- Top class A+++ air to water heating solutions with ESTIA R32
- Environmentally-friendly refrigerants
- Optimal temperature control solutions for increased precision

> Entirely scalable solutions

Toshiba Air Conditioning develops cutting-edge technologies and advances that benefit people everywhere by offering the ideal combination of comfort and ecologically-superior products for residential, light commercial and large building applications.

> Superior manufacturing quality

Toshiba Air Conditioning's innovations ensure comprehensive building air conditioning solutions which have been subject to strict evaluation testing to guarantee world-class reliability.

Third party institute certifications for quality, safety and performance, guaranteed (TÜV, Eurovent, WEEE, RoHS, REACH, Intertek, Keymark).

(1) Source: Toshiba Carrier Corporation (as of December 21, 2020)



> DIRECT LINES TO TOSHIBA AIR CONDITIONING

EUROPE & CIS

> **ARMENIA | AZERBAIJAN | BELARUS |
GEORGIA | KAZAKHSTAN |
KYRGYZSTAN | MOLDOVA |
MONGOLIA | TAJIKISTAN |
TURKMENISTAN | UKRAINE | UZBEKISTAN**
AHI CARRIER FZC
www.toshibaaircon.ru
Kievskaya st. 7, entrance 7, floor 3,
121059, Moscow, RUSSIA
TEL: +(7) 495-937-42-41
E-mail: ahi@ahi-carrier.ru

> **AUSTRIA | BOSNIA AND HERZEGOVINA |
CROATIA | CZECH REPUBLIC |
HUNGARY | MONTENEGRO |
REPUBLIC OF MACEDONIA |
REPUBLIC OF SERBIA | SLOVAKIA |
SLOVENIA | KOSOVO**
AIR COND
KLIMAANLAGEN-HANDELSGESELLSCHAFT m.b.H
www.toshiba-klima.at
Haushamer Straße 2, A-8054,
Graz-Seiersberg, AUSTRIA
TEL: +(43) 316-8089
FAX: +(43) 316-8263-71

> **BELGIUM | LUXEMBOURG**
INTERCOOL NV
www.toshiba-airco.com
Delta Business Park Satenrozen,
Satenrozen 1A, 2550 Kontich, BELGIUM
TEL: +(32) 3-825-55-66

> **BULGARIA**
AHI CARRIER HVAC BULGARIA FOOD
www.toshiba-aircon.bg
Trade Center Europe,
Building 6, floor 3, office 6
7 Iskarsko Shose Blvd, 1528 Sofia, BULGARIA
TEL: +(35) 929-483-960
FAX: +(35) 929-483-990
E-mail: bginfo@ahi-carrier.eu

> **DENMARK**
GIDEX A/S
www.gidex.dk
Vinkelvej 4, 8620 Kjellerup, DENMARK
TEL: +(45) 8688-3422
FAX: +(45) 8688-3026
OR
Korshøj10, 3600 Frederikssund, DENMARK
TEL: +(45) 4731-3221
FAX: +(45) 4731-5835

> **ESTONIA | FINLAND | LATVIA |
LITHUANIA**
OY COMBI COOL AB
www.toshibapro.fi
Pakkalantie 19, 01510 Vantaa, FINLAND
TEL: +(358) 9-777-12360
E-mail: asiakaspalvelu@toshiba-hvac.fi

> **FRANCE**
**TOSHIBA SOLUTIONS DE CHAUFFAGE
& CLIMATISATION - TFD SNC**
www.toshiba-confort.fr
Rue Aimé Cotton, Parc Technoland -
2, Allée Toscane F- 69800 Saint-Priest, FRANCE
TEL: +(33) 810 723 723

> **GERMANY**
**TOSHIBA KLIMASYSTEME BEIJER REF
DEUTSCHLAND GMBH**
www.toshiba-klima.de
Ohmstrasse 4, 85716 Unterschleissheim, GERMANY
TEL: +49 (0) 89 - 370 67 56 - 0
E-mail: info@toshiba-hvac.de

> **GREECE | CYPRUS | ALBANIA**
**AHI CARRIER SOUTH EASTERN EUROPE
AIR CONDITIONING S.A.**
www.toshiba-aircon.gr
18, Kifissou Avenue,
10442, Athens, GREECE
TEL: +(30) 210-67-96-300
FAX: +(30) 210-67-96-390
E-mail: grinfo@ahi-carrier.eu

> **ITALY**
TOSHIBA ITALIA MULTICLIMA
www.toshibaclima.it
Divisione di BEIJER REF Italy S.r.l.
Viale Monza 338 - 20128 Milano, ITALY
TEL: +(39) 02-2529421
FAX: +(39) 02-25294295
Customer support: +(39) 02-25200850
E-mail: info.toshiba@toshiba-hvac.it

> **MALTA**
CUTRICO LTD
www.cutrico.com
Triq Il-Haddiemca, Zone 3, Central Business
District, Birkirkara CBD 3080, MALTA
TEL: +(356) 214-98658 / 214-98693
E-mail: sales@cutrico.com

> **NETHERLANDS**
INTERCOOL TECHNICS BV
www.toshiba-airco.com
Pascalstraat 5, Postbus 453-3330 AL
Zwijndrecht, NETHERLANDS
TEL: +(31) 78-629-1230

> **NORWAY**
ABK-QVILLER AS
www.abkqviller.no
Brobekkveien 80, PO Box 64
Vollebekk, N-0516 Oslo,
NORWAY
TEL: +(47) 23-17-05-20
E-mail: post@abkqviller.no

> **POLAND**
BEIJER REF POLSKA SP. Z O.O.
www.toshiba-hvac.pl
Al. Krakowska 22, Sękocin Nowy
05-090 Raszyn, POLAND
TEL: +(48) 22-715-58-58
E-mail: kontakt@toshiba-hvac.pl

> **PORTUGAL**
BEIJER REF PORTUGAL
www.toshiba-ar.pt
North Office Rua Engº.
José Rodrigo de Carvalho,
25. Pólo Industrial do Loureiro
4480-119, Árvore Vila do Conde,
PORTUGAL
TEL: +(351) 252-240-660
Email: henrique.vieira@toshiba-hvac.pt
BEIJER REF PORTUGAL
www.toshiba-ar.pt
South Office
Rua Prof. Dr. José Pinto Peixoto,
34-B 2740-252 Porto Salvo,
PORTUGAL
TEL: +(351) 214-230-780
Email: jose.adriano@toshiba-hvac.pt

> **ROMANIA**
AHI CARRIER ROMANIA SRL
www.toshiba-hvac.ro
2Intrarea Nestorei 1, Corp B, Et.5,
Sector 4 RO-040295 Bucuresti,
ROMANIA
TEL: +(40) 214-050751
FAX: +(40) 214-050753
E-mail: roinfo@ahi-carrier.eu

> **RUSSIA**
RUSSIA AHI CARRIER LLC
www.toshibaaircon.ru
Kievskaya st. 7, Entrance 7, Floor 3,
121059, Moscow, RUSSIA
E-mail: ahi@ahi-carrier.ru

> **SPAIN**
BEIJER ECR IBÉRICA, S.L.U
www.toshiba-aire.es
Calle San Dalmacio 18,
28021, Madrid, SPAIN
TEL: +(34) 91-218-23-00
E-mail: hola@toshiba-hvac.es



> SWEDEN

CLIMA SVERIGE AB

www.clima.se

Fagerstagatan 29, 163 53 Spånga,
SWEDEN
TEL: +(46) 8-580-074-00

> SWITZERLAND

KRÜGER+CO.AG

www.krueger.ch

Winterhaldenstrasse 11,
9113 Degersheim, SWITZERLAND
TEL: +(41) 71-372-82-82

> TURKEY

ALARKO CARRIER SAN. TIC. A. S

www.alarko-carrier.com.tr

GOSB Gebze Organize Sanayi
Bolgesi Sahabettin Bilgisu Cad.
41480, Gebze Kocaeli, TURKEY
TEL: +(90) 262-648-6000

> UNITED KINGDOM | IRELAND

TOSHIBA CARRIER UK LTD

www.toshiba-aircon.co.uk

United Technologies House,
Guildford Road,
Leatherhead, Surrey, KT22 9UT,
UNITED KINGDOM
TEL: +(44) 137-222-0240

MIDDLE EAST

> AFGHANISTAN | BAHRAIN | IRAQ | KUWAIT | OMAN | QATAR | SAUDI ARABIA | UAE | YEMEN

AHI CARRIER FZC

www.ahi-carrier.com

PO. Box 122341, B1 (22-24) SAIF Zone,
Sharjah, UNITED ARAB EMIRATES
TEL: +(971) 6-504-5700
E-mail: ahi@ahi-carrier.com

> EGYPT

MIRACO CARRIER

K28 Cairo-Alex Road, Abou Rawash,
Cairo, EGYPT
TEL: +(20) 2-353-66-202
FAX: +(20) 2-353-66-840

> ISRAEL

TADIRAN ENERGY

9 Ravnitzky
St. Petah Tikva, 4912502, ISRAEL
TEL: +(972) 3 - 9283334
FAX: +(972) 3 - 9283336
E-mail: Energy@tadiran-group.co.il

> JORDAN

NTC-CARRIER

Amman, Al Rabieh, Al shareef Nasir Bin
Jameel St. AL WATHEQ COMPLEX PO.Box
9268 Amman 11191, JORDAN
TEL: +(961) 5-465159 or 305
FAX: +(962) 6-556-3838
E-mail: info@carrierjo.com

> LEBANON

THE NATIONAL TRADING CORPORATION SAL

Hadath, Otis Building,
PO. Box 11-8680, 1107 2270 Riad El
Solh, Beirut, LEBANON
TEL: +(961) 1-575-555
FAX: +(961) 1-571-111

AFRICA

> AFRICA (North, South, West, East and Central) | REUNION ISLAND

AHI CARRIER FZC

www.ahi-carrier.com

PO. Box 122341, B1 (22-24) SAIF Zone,
Sharjah, UNITED ARAB EMIRATES
TEL: +(971) 6-504-5700
E-mail: ahi@ahi-carrier.com



➤ “Committed to the Future”

Going further than just products and beyond their basic functions, to create reliable and safe solutions that can interact with each other and with users.

Incorporating Toshiba’s technical building management systems, the world is made simpler, clearer and more effective.

QUALITY RELIABILITY ENVIRONMENT PROFITABILITY SIMPLICITY

> TAILORED TO MEET CHALLENGES

Toshiba Air Conditioning, with heat pump technology at its core, aims to be an environmentally creative company which contributes to society and the global environment. A commitment to growth on a global scale by offering the highest-quality products and services based on heat application solutions which respond to all of our customers' needs.

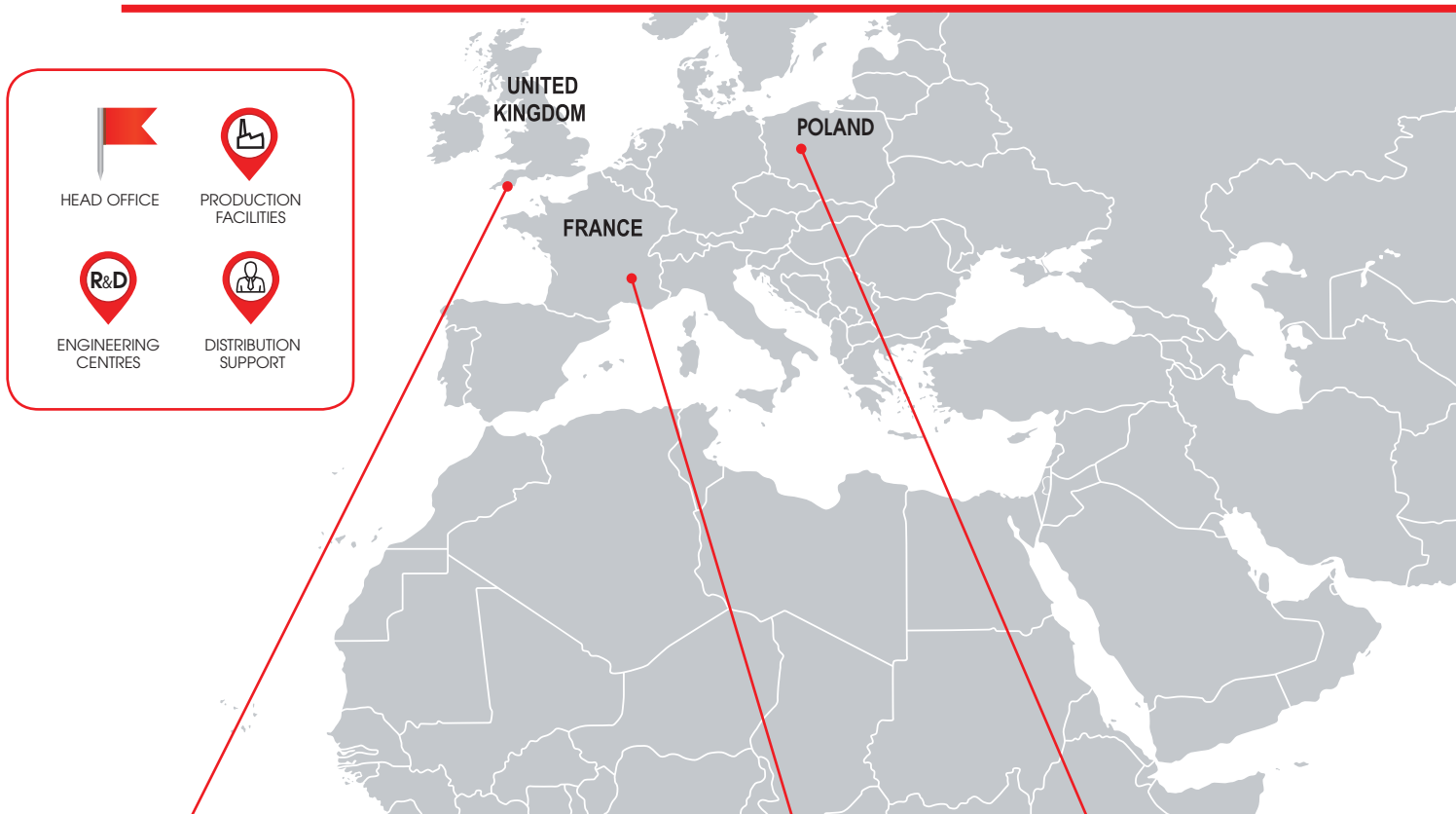

PLYMOUTH, UNITED KINGDOM



**TCEU - DISTRIBUTION SUPPORT
and
TCEU - ENGINEERING CENTRE**

MONTLUEL, FRANCE



**TCEU - ENGINEERING CENTRE
and
TOSHIBA EMEA**

GNIEZNO, POLAND



TCAE - PRODUCTION FACILITIES



HARYANA, INDIA

TCAI - PRODUCTION FACILITIES



PATHUMTHANI, THAILAND

TCTC - ENGINEERING CENTRE



HANGZHOU, CHINA

TCAC - PRODUCTION FACILITIES

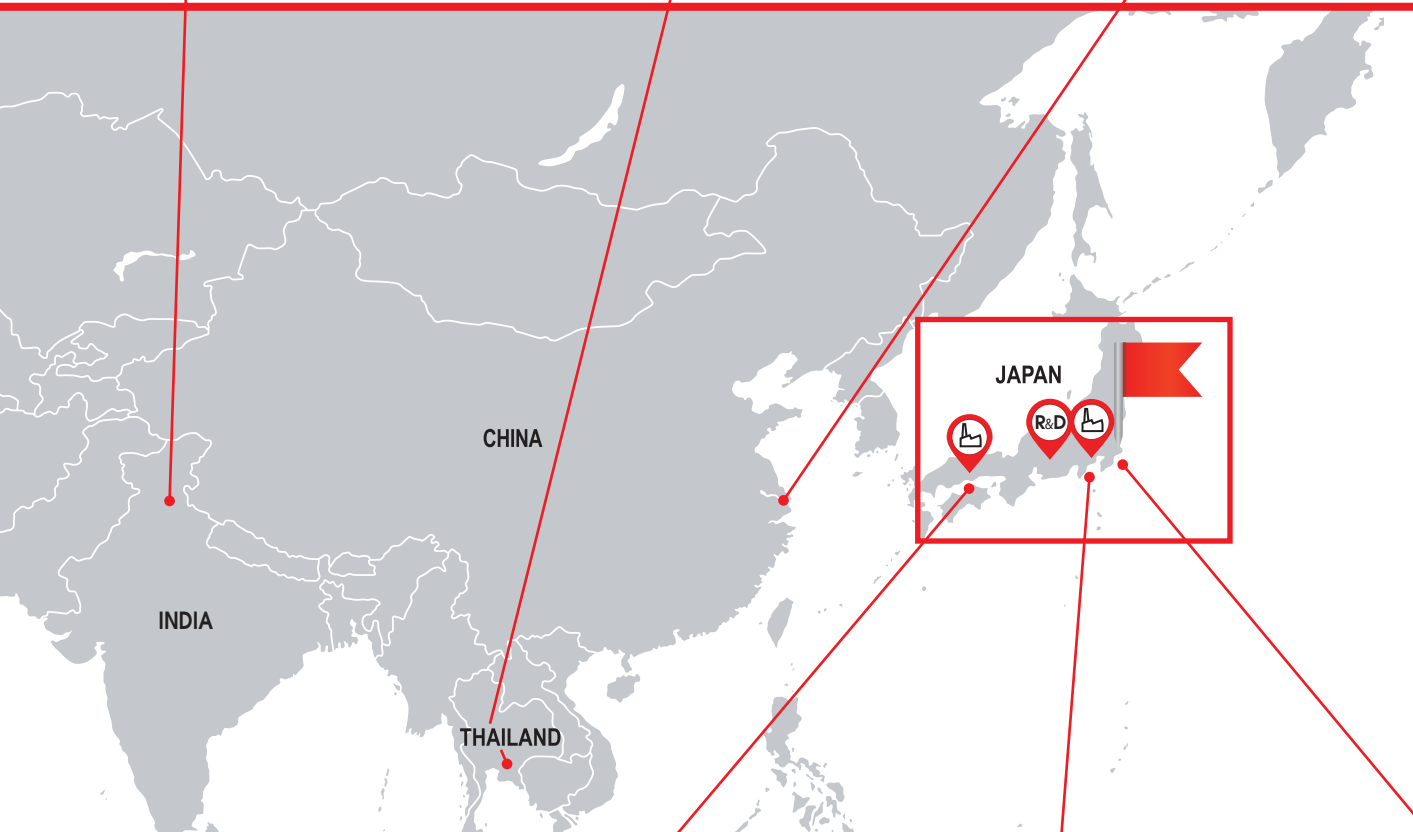

TSUYAMA-CITY, JAPAN

TCC - PRODUCTION FACILITIES



FUJI-CITY, JAPAN

TCC - PRODUCTION FACILITIES
and
TCC - ENGINEERING CENTRE



KAWASAKI-CITY, JAPAN

TCC - HEAD OFFICE

> LEADING THE WAY TO EXCELLENCE

Toshiba Air Conditioning's strengths centre on in-house research and development of advanced technologies and core components. They are accompanied by the production of air conditioners under the highest international standards, which incorporate quality control checks at each production stage for a wide variety of residential, commercial and business environments.

> A global innovation network

Toshiba Air Conditioning has R&D centres in Japan, Europe, Thailand and China. Its global research activities are managed and integrated to ensure all research sites collaborate to provide innovative solutions to customers across the world.

The Toshiba brand proudly holds more than 1200 patents in Japan and abroad, an outstanding number for any company.

Each year since 1994, Toshiba Air Conditioning has received a prestigious award for its significant achievements in air conditioning. This demonstrates Toshiba's innovative spirit, a relentless drive to improve its products and systems.

> Products designed to perform, engineered to perfection

In 1981 Toshiba Air Conditioning was the first company to incorporate inverter technology into air conditioning systems and has maintained its technological advantage over its competitors ever since. The development of the new and exclusive DC hybrid inverter system has reaffirmed this ability to innovate and maintain technological leadership in a fast-growing market. But for Toshiba Air Conditioning, innovation also means strong commitment to international institutions that carefully evaluate the impact of new technologies on the environment.

Toshiba Air Conditioning combines technological development with consideration for future generations: resulting in a range of extremely energy-efficient air conditioners, reducing greenhouse gas emissions at their source. Its continuous research into the development of inverter technology has provided remarkable results, both with regards to meeting the required comfort levels and continually reducing the system's energy consumption.



Quality production



Outdoor units production



Indoor units production

> In line with European standards

To improve its environmental responsibility, Toshiba Air Conditioning offers products that meet the following European standards:

EN 14511

Air conditioners, liquid chilling packages and heat pumps with electrically-driven compressors for space heating and cooling. Test methods.

EN 14825

Air conditioners, liquid chilling packages and heat pumps, with electrically-driven compressors, for space heating and cooling. Testing and rating with part loads and calculation of seasonal performance.

EN 16147

Heat pumps with electrically-driven compressors. Testing, performance rating and requirements for marking domestic hot water units.



All products ensure high operating efficiency and are cost-effective solutions for heating and cooling, guaranteed by their participation in the Eurovent programme. This acts as a guarantee for customers and users that the products will operate in accordance with the design specifications and that the data published is realistic.

Toshiba participates in the Eurovent Certification Performance programme for AC1, AC2 & VRF.

Check ongoing validity of certificate:

www.eurovent-certificate.com

For Estia certification, refer to Keymark heat pump certification program:

www.heatpumpkeymark.com

The entire production process is certified by international quality assurance institutes. Toshiba's air conditioners gained ISO 9001 certification for quality control management and quality insurance.



> ENVIRONMENTAL RESPONSIBILITY

> Toshiba Carrier Group's Basic Policy for the Environment

The Toshiba Group contributes to society by providing environmentally responsible products throughout the world. It develops and manufactures air conditioning, hot water supply and ventilation systems as well as compressors with business operations that aim to reduce environmental impact.

We believe that it is our responsibility to maintain the health of the global environment – an irreplaceable asset for future generations – and we contribute to the development of a sustainable society by promoting environmental activities designed to create a world that is low carbon, recycling-focused and environmentally harmonious.

> Environmental Vision

Throughout the life cycle of products from manufacture and use to recycling and reuse, Toshiba Group will strive to provide safer and more comfortable lifestyles and create enriched value for customers. Toshiba Group will also strive for harmony with the Earth by working to mitigate climate change, using resources efficiently, and managing chemicals properly in order to reduce environmental impacts. Our environmental management strategy has a name: Environmental Vision 2050.

> Action Plan

In order to realize an ideal state of the Earth in 2050, Toshiba Group formulates Environmental Action Plan for medium-term goals and manages specific environmental activities and their targets.

Under the ongoing Sixth Environmental Action Plan for the period from FY2017 to FY2020, we set goals for 15 items in two areas: or namely activities to reduce environmental impacts in the lifecycles of products and services (Business), and basic activities to support such activities (Management).

For further details on Toshiba Group's Environmental vision, please click on http://www.toshiba.co.jp/about/press/2020_11/pr1001.htm



> Toshiba's commitment to **the future**

We all want to play an active part in preserving our planet.

At Toshiba Air Conditioning, we believe we can make a difference. With a global vision for our evolving world, we are committed to advancing research and developing super-energy-efficient and cleaner technologies that not only use significantly less energy but help maintain air quality using state-of-the-art air purification systems for homes and businesses.

This commitment is in line with the 2030 European climate and energy package targets.

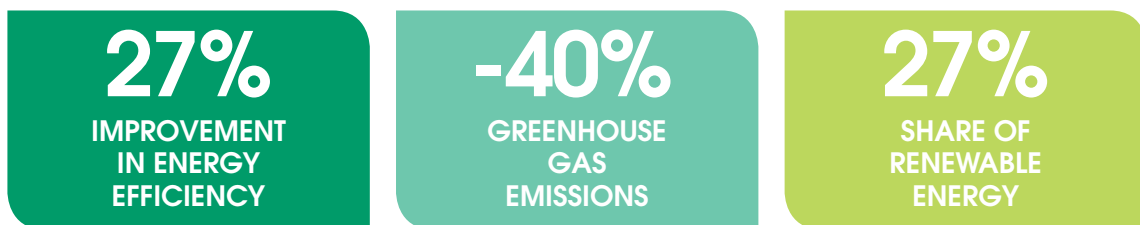

Toshiba also assesses the impacts of its business activities, products and services on the environment and sets targets aiming to reduce environmental impacts and prevent pollution.



In addition to mitigating climate change and reducing pollution, Toshiba Group is also conducting group-wide environmental activities based on the recognition of the importance of maintaining and expanding environments for conserving biodiversity.

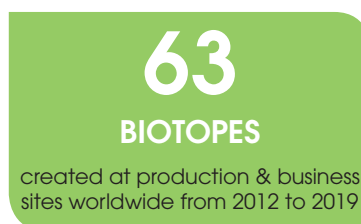

Source: TOSHIBA CORPORATION Environmental Report 2019

QUALITY RELIABILITY ENVIRONMENT PROFITABILITY SIMPLICITY



QUALITY RELIABILITY ENVIRONMENT PROFITABILITY SIMPLICITY

➤ “Committed to efficiency and comfort”

Every field has its own requirements and specifics directly related to its business and the space it occupies, be it residential, shops, offices or hotels. Toshiba reinvigorates spaces, creates comfortable environments and encourages productivity.

> FOR A MORE INSPIRING WORLD



> A range in line with our environmental vision

Toshiba is offering a complete range of air-to-air products dedicated to cooling and heating in comfort applications. With individual system solutions from 2 to 28kW, we are able to address residential and light commercial markets requirements.

Residential

HAORI is a truly elegant air conditioner, featuring a stylish textile fabric cover that uses Toshiba inverter and compressor technology with R32, offering A+++ performance and year-round comfort.

Light commercial

A full range of Toshiba R32 light commercial systems is available on the European market including a R32 Super Digital Inverter with best in class efficiency.

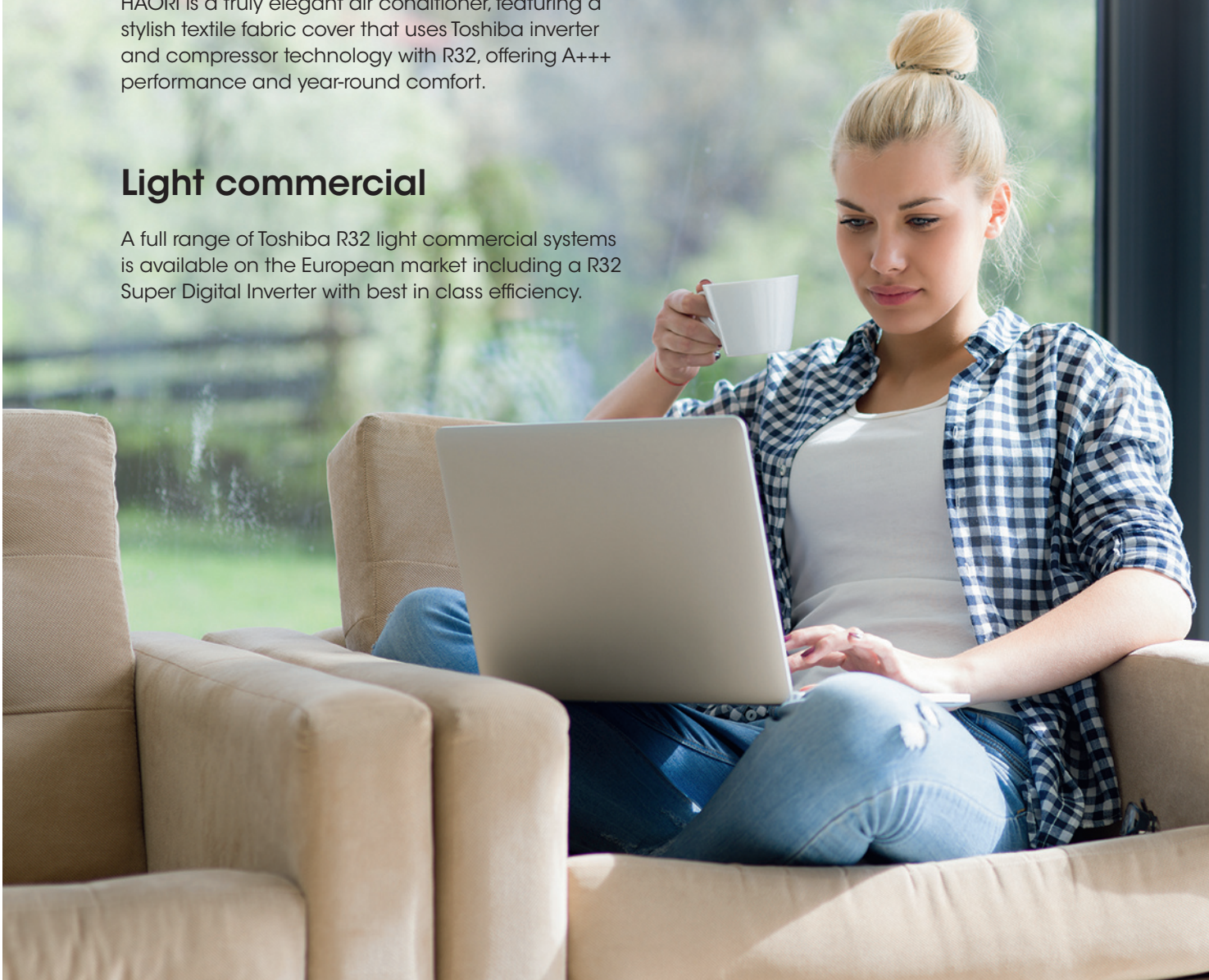



> An **easy** change...

The fundamental design and control of Toshiba systems remains unchanged with the new R32 refrigerant. Toshiba's unique combination of twin rotary compressors and all inverter driven control also contributes to guaranteed accuracy and expertise of flawless Japanese quality. All these result in the high level of performance and efficiency Toshiba customers are used to.



> ...to the **benefit** of all

Environmental oriented

- The perfect balance between environment safety and your comfort
- Energy efficiency increased for greater savings

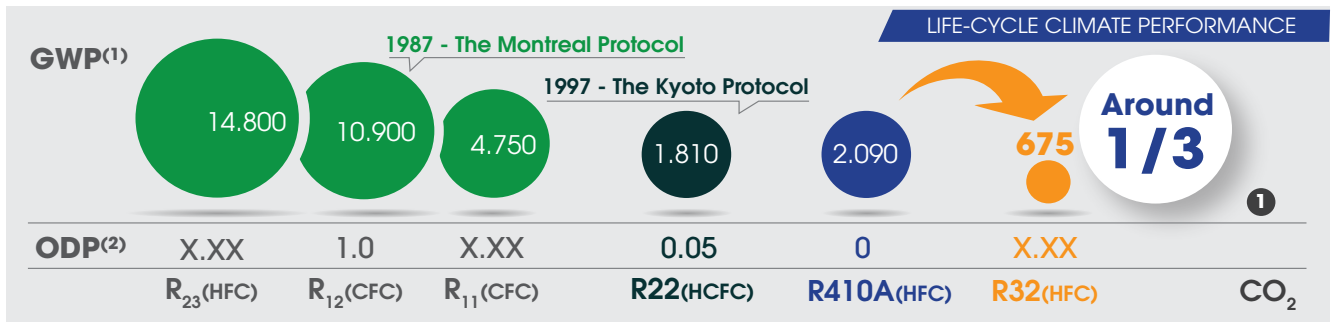

⁽¹⁾ Global Warming Potential
⁽²⁾ Ozon Depletion Potential

Installer friendly

- Working pressures for R410A and R32 refrigerant are similar
- R32 refrigerant can be easily charged in both liquid or gas state
- Safety commissioning instructions are similar to those for R410A
- R32 and R410A equipments is the same except for the refrigerant recovery pump and the reclaim cylinder
- Toshiba flare joints certified ISO14903

> The **right** choice to make

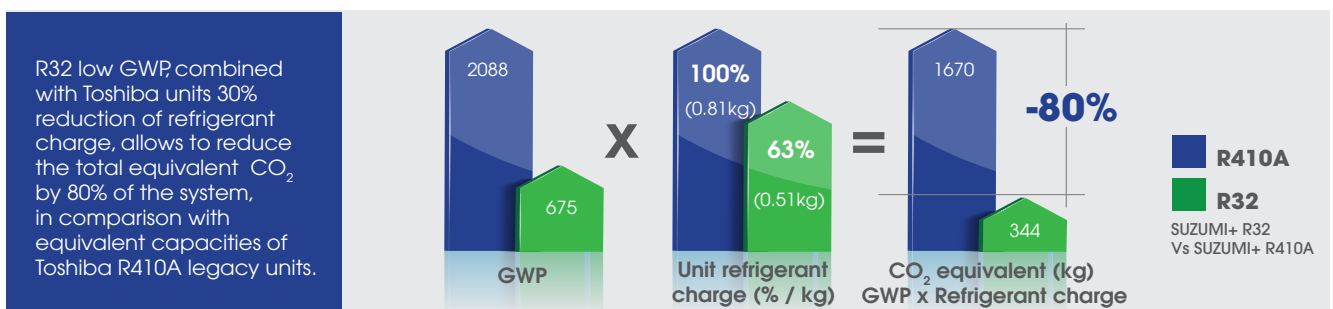

> F-GAS COMPLIANCE

> TOSHIBA AIR CONDITIONING RESPONDS TO REGULATORY EVOLUTIONS

The European F-gas regulation (517/2014) has been in force since 1 January 2015, it aims to protect the environment by reducing greenhouse gas emissions and progressively deploying new rules related to the use of HydroFluoroCarbons refrigerants (HFCs) in heating and cooling systems.

This regulation will ensure manufacturers turn to refrigerants with lower Global Warming Potential (GWP).

The phase down is a step-by-step approach, this regulation introduces an ambitious gradual reduction of HFC quantities that are put on the market in the EU by HFC producers and distributors (in equivalent tons of CO₂), with an initial reduction of 37% from 2018 and a final objective of cutting quantities by 79% by 2030.

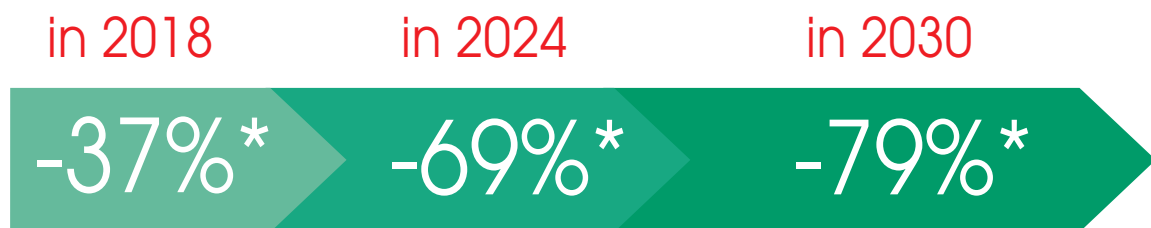

*HFC consumption compared to equivalent tons of CO₂

> Your safety first and foremost

Based on the requirements of the F-gas regulation, only certified installers can carry out Dx system installations. The implementation of systems using HFC requires thus some specific precautions such as a strict control of the leakages and a periodic checking of the refrigerant charge.

For equipment containing			Leak checks without leak detection	Leak checks with leak detection
Between 5 and 50 tonnes CO ₂ equivalent	2.38 and 23.8kg R410A	7.41 and 74.1kg R32	Every 12 months	Every 24 months
Between 50 and 500 tonnes CO ₂ equivalent	23.8 and 238kg R32	74.1 and 740kg R32	Every 6 months	Every 12 months
More than 500 tonnes CO ₂ equivalent	More than 238kg R410A	More than 740kg R32	Every 3 months	Every 6 months

> Toshiba leak detection system

Residential

Increase console installation flexibility!

R32 leak detection sensor is available as an option for RAS Console. This accessory offers a total flexibility to install a Console with large R32 multisplit systems in average room surface (minimum room surface 7sqm in combination with RAS-5M34U2AVG according to IEC 60335-2-40).



Light Commercial

This is the first Toshiba product delivered with an embedded leak detection sensor.

To ease product integration in every type of light commercial applications, Toshiba floor standing unit is delivered with plug & play embedded R32 leak detection sensor. Its integrated remote controller will inform end user on sensor status and leakage risks with an alarm.



Business

Whatever your constraints, we have the leak detection solution for VRF applications.

• **LEAK DETECTION VRF SENSOR ONLY**

Each room is fitted with a leak detection sensor. When the refrigerant concentration level exceeds EN378 limits the sensor is activated, an audible and visual alarm is triggered and the affected FCU will also stop displaying a fault code.



Audible and visual alarm when a leak is detected

• **LEAK DETECTION VRF AND FCU ISOLATION**

FCUs can be isolated with individual valves on liquid and gas piping lines.

This system ensures that only the FCU concerned is isolated, allowing the rest of the system to continue operating.



Audible and visual alarm including the isolation of concerned indoor units when a leak is detected

• **LEAK DETECTION VRF AND PUMP DOWN**

The refrigerant leak is indicated whereas mechanical isolation and pump back of refrigerant to the outdoor unit are set to decrease potential harm to occupants, reducing refrigerant loss and negative impacts on the environment.

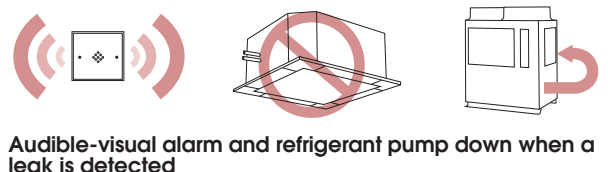

Audible-visual alarm and refrigerant pump down when a leak is detected

Toshiba Air Conditioning leak detection solutions are compliant with EN378 standard related to buildings open to the public and thus answer some of the safety constraints.

ECODESIGN & ENERGY LABELLING

The European 2030 climate and energy framework for improving energy efficiency will have a significant impact on the heating, ventilation and air conditioning sectors.

Today, buildings are responsible for the largest energy consumption, with HVAC systems being the most energy-intensive of all. The HVAC sector is now committed to manufacturing energy-efficient products for its clients to ensure sustainable development.

ECODESIGN

In the European Union, the Ecodesign Directive encourages HVAC manufacturers to design products taking into consideration their environmental impact throughout entire lifecycle. It establishes a framework for the setting of mandatory energy efficiency requirements for all energy-related products (ERPs).

Ecodesign and Energy Labelling for Air-to-Water heat pumps

Air-to-Water heat pumps have been subject by the Ecodesign (< 400kW) and Energy Labelling (< 70kW) regulations since 26 September 2015. Heat pumps launched before this date are not concerned and all must conform to display the CE mark.

For more information visit
www.ecodesign.toshiba-airconditioning.eu

New energy efficiency metric: Seasonal efficiency (SEER and SCOP)

The Seasonal Coefficient of Performance, is a new European parameter to rate heat pumps in terms of energy efficiency. It is an update to the Coefficient of Performance, which previously recorded the power consumed to power produced ration in heating and cooling modes for one operating point.

Unlike the EER/COP, the SEER/SCOP take into account performances during cooler seasons because it includes temperature variations by including numerous realistic measurement points. When combined, this results in a more accurate energy classification.

SEER/SCOP compared to EER/COP

TEMPERATURE		CAPACITY (KW)		AUXILIARY MODES (KWH)		HOURS	
EER COP	SEER SCOP	EER COP	SEER SCOP	EER COP	SEER SCOP	EER COP	SEER SCOP
One temperature requirement	Numerous rating temperatures (range of average temperatures)	Full load	Partial load + Full load	Auxiliary power modes are not considered	Incl. consumption auxiliary modes: - Standby mode - Off mode - Thermostat off, etc.	N/A	Number of hours at each air temperature (in hours)

SEASONAL COEFFICIENT OF PERFORMANCE CALCULATION

This is the ratio between annual heating/cooling demand and annual energy input over an entire heating/cooling season.

$$\begin{aligned}
 \text{SCOP} &= \frac{\text{ANNUAL HEATING DEMAND}}{\text{ANNUAL ENERGY INPUT}} \\
 \text{SEER} &= \frac{\text{ANNUAL COOLING DEMAND}}{\text{ANNUAL ENERGY INPUT}}
 \end{aligned}$$



ENERGY LABELLING

The Energy Labelling regulation was created to offer end users understandable information about a product's energy efficiency rating. European Energy Labelling regulations also assign ratings from G to A++ based on their energy efficiency; inciting better ratings in the sector and providing clients with clearer information.

Space heating

Energy class @ 47/55° (average climate)

Noise power level indoor units dB (A)

Noise power level outdoor units dB (A)

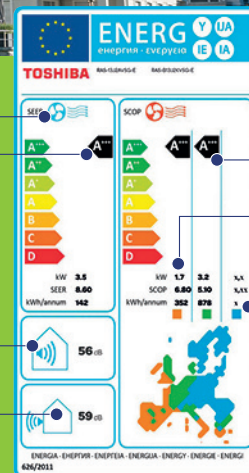

Energy labelling example

Energy class @ 30/35° (average climate)

Heating capacities (P rated) @ 55° in cold, average & warm climate

Heating capacities (P rated) @ 35° in cold, average & warm climate

Designed for the future

Toshiba Air Conditioning is committed to designing products and solutions with increasingly lower environmental impacts. This subsequently reducing indirect CO₂ emissions generated by electricity consumption. Toshiba Air Conditioning's long-standing commitment to sustainable development is ahead of schedule for the European climate and energy package requirements for 2030.

All Toshiba Air Conditioning products sold today in Europe are fully compliant with the latest Ecodesign directives.

Lot 1: Air-to-Water heating systems up to 400kW including air-to-water heat pumps >>> ESTIA SPLIT.

Lot 2: Water heaters and hot water storage tanks. Including ESTIA DHW-HP

Lot 6: Residential and non residential ventilation including air treatment VN units.

Lot 10: Air-to-Air heat pumps up to 12kW >>>> SEYIA, SHORAI Edge, HAORI, DAISEIKAI 9, Console, Digital Inverter, Super Digital Inverter.

Lot 11: Electric motors from 125W to 500kW including ventilation fans.

Lot 21: Heat pumps above 12kW including residential, light commercial systems and VRF >>> DI, SDI, Big DI, MiNi SMMS-e, SMMS-e, SHRM-e, SMMS-u.

Toshiba Air Conditioning's dedicated public website provides energy labels with detailed performances for all systems.

For more information visit www.ecodesign.toshiba-airconditioning.eu

EXPERIENCE THE FUTURE



> TO GUIDE YOU



MAX EFFICIENCY



CAPACITY



OPERATION



D.H.W



SOUND
LEVEL



AIR FLOW



INDIVIDUAL
HOUSING



COLLECTIVE
HOUSING



SHOPS



SHOPPING
CENTRES



BUSINESSES



ADMINISTRATION



HEALTHCARE



HOTELS

RESIDENTIAL AIR TO WATER

P32



RESIDENTIAL AIR TO WATER

RESIDENTIAL AIR TO AIR

P50



RESIDENTIAL AIR TO AIR

LIGHT COMMERCIAL

P



LIGHT COMMERCIAL

BUSINESS

P



BUSINESS

CONTROLS

P 6



CONTROLS

NEW AIR-TO-AIR SYSTEMS

HAORI, the air conditioner that respects your universe with a truly elegant design

HAORI



Top energy class A+++/A+++

SEER 8.7 / SCOP 5.1

Ultra Quiet system:

ODU down to 37dB(A) / IDU down to 19dB(A)

Toshiba IAQ with Ultra Pure filter & Ionizer
Wi-Fi module integrated

MAKE YOUR AIR CONDITIONER SMART



works with the Google Assistant

WORKS WITH amazon alexa



Download on the App Store

ANDROID APP ON Google play

HAORI features energy monitoring and speaker voice control functions compatible with Google Home Assistant & Amazon Alexa.

REMOTE CONTROLLER



Toshiba HAORI remote control offers a magnetic wall-mounted holder.

NEW AIR-TO-WATER HEAT PUMP

Top energy class A+++/A++

Up to 65°C leaving water temperature

Wall-mounted or All-In-One hydro modules

ESTiA



New generation of Toshiba ESTIA Air-to-Water heat pump split system, with low GWP refrigerant R32.

Large lineup 4, 6, 8 & 11kW

Designed to deliver the right temperature for space heating and to produce domestic sanitary hot water throughout the year, even in extreme conditions down to -25°C.

The ESTIA system is fully reversible offering the additional advantage of providing cooling comfort in warmer seasons.

The All-in-One or wall-mounted hydro module will perfectly meet new house building or boiler replacement in renovation.

The large screen of the remote controller is designed to be simple, intuitive and easy to use. ESTIA is also compatible with the latest generations of connected thermostat.

ESTIA R32 can be controlled remotely via a smartphone thanks to its wireless interface option compatible with the Toshiba Home AC Control App.

NEW AIR-TO-AIR SYSTEMS

HAORI

LET YOUR
STYLE
BE YOUR
GUIDE

Fabrics with infinite possibilities.
Easy to dress, just peel and stick.

- Blush grey
- Dark grey
- Light Grey
- Grey beige
- Dark brown
- Emerald blue

HAORI

A+++
in cooling
and heating

Ultra-quiet system
Less than
19 dB(A)

Silent operation
Down to
37 dB(A)

> NEW LIGHT COMMERCIAL PRODUCTS

A more efficient high static pressure duct



E1DTP Duct

High static pressure duct models 8/10HP have been optimized for maximized efficiency and go far beyond the Lot 21 Tier 3 regulation.

> NEW BUSINESS PRODUCTS

The ultimate VRF system



SMMS-u 8 to 24HP

SMMS-u, the latest generation of Toshiba VRF, offers a totally new redesigned chassis, a new compressor as well as a new heat exchanger to achieve unrivalled efficiency and outstanding comfort levels with low environmental footprint.

Super Slim Duct



SPHY Slim Duct

This new slim duct generation for hotel applications combines a wide capacity range from 0.3 to 3HP with a reduced depth of 450mm for all models and a sound level down to 25dB(A).

The way to excellence



YHP Cassette

This is the indoor unit of your dreams boasting a host of assets: 150mm height tiny chassis, capacity from 0.3 to 1.3HP, low sound level, air purifier, motion sensor, white design and even more.

3/3.3/4HP High wall



MMK High Wall

Designed and manufactured by Toshiba, this new 10kw/4HP high wall is the most attractive solution to cool and heat large rooms.

SMMSu

SUPER MODULAR MULTI SYSTEM

The ultimate VRF system



ON YOUR OWN AS A FAMILY IN A GROUP ON YOUR OWN



Surpassing well-being

Following European commitments to reduce emissions by 20% by 2020, energy waste from residential heating and domestic hot water has been identified as a possible reduction target. Air-to-water heat pumps are classed as a form of renewable energy technology, contrary to heating systems that rely on fossil fuels or inefficient electrical heating.

They are now considered to be ideal solutions for space heating and domestic hot water. Residential heat production using gas, oil or electricity increases atmospheric CO² emissions levels. In addition, these traditional heating systems are less efficient and therefore have higher running and maintenance costs. Toshiba Estía air-to-water heat pumps are the ideal solution for increasing energy efficiency, using air as its main source of energy. This all-in-one system is designed to ensure that the right temperature for space heating and domestic sanitary hot water is achieved quickly and efficiently, with the additional advantage of also functioning as a cooling source, in the warmer seasons.

















**> RESIDENTIAL
AIR TO WATER**

AS A FAMILY IN A GROUP ON YOUR OWN AS A FAMILY

ESTIA SPLIT

Toshiba ESTIA air-to-water high efficiency Heat Pumps provide space heating and/or comfort cooling throughout the year.

The compact and silent outdoor units are associated with a large range of hydraulic modules. ESTIA solutions are available in several versions:

ESTIA SPLIT - Rated heating capacities (kW)		4.0	6.0	8.0	11.0	14.0	16.0
	ESTIA SPLIT R32 All-In-One - 1 zone 220/240V-1-50Hz	● 	●	● 	●		
	ESTIA SPLIT R32 All-In-One - 2 zones 220/240V-1-50Hz			● 	●		
	ESTIA SPLIT R32 Wall mounted 220/240V-1-50Hz	● 	●	● 	●		
	ESTIA SPLIT R410A Wall mounted 220/240V-1-50Hz	● 		● 	● 		
	ESTIA SPLIT R410A Wall mounted 380/400V-3N-50Hz				● 	●	●

- R32
- R410A



ESTIA Domestic Hot Water Heat Pump volumes (Litres)	190	260
	●	●

- R134a

ESTIA SPLIT

RESIDENTIAL AIR TO WATER

Space heating for any emitters

-  Under floor heating
-  Medium or low temperature radiators
-  Fan coils
Comfort cooling & heating

Domestic hot water production

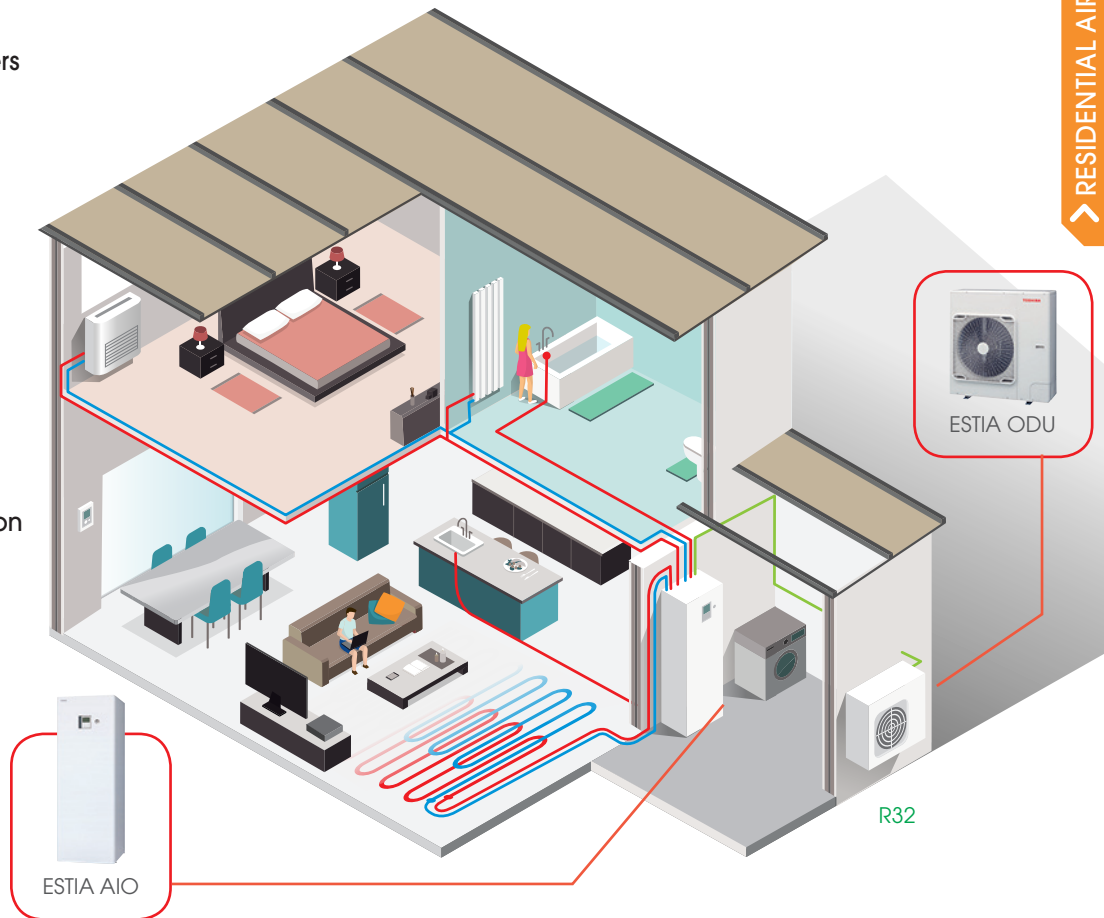

With ESTIA R32 Wireless Interface & Toshiba Home AC Control APP, make your heat pump smart and enhance your comfort at home or away.

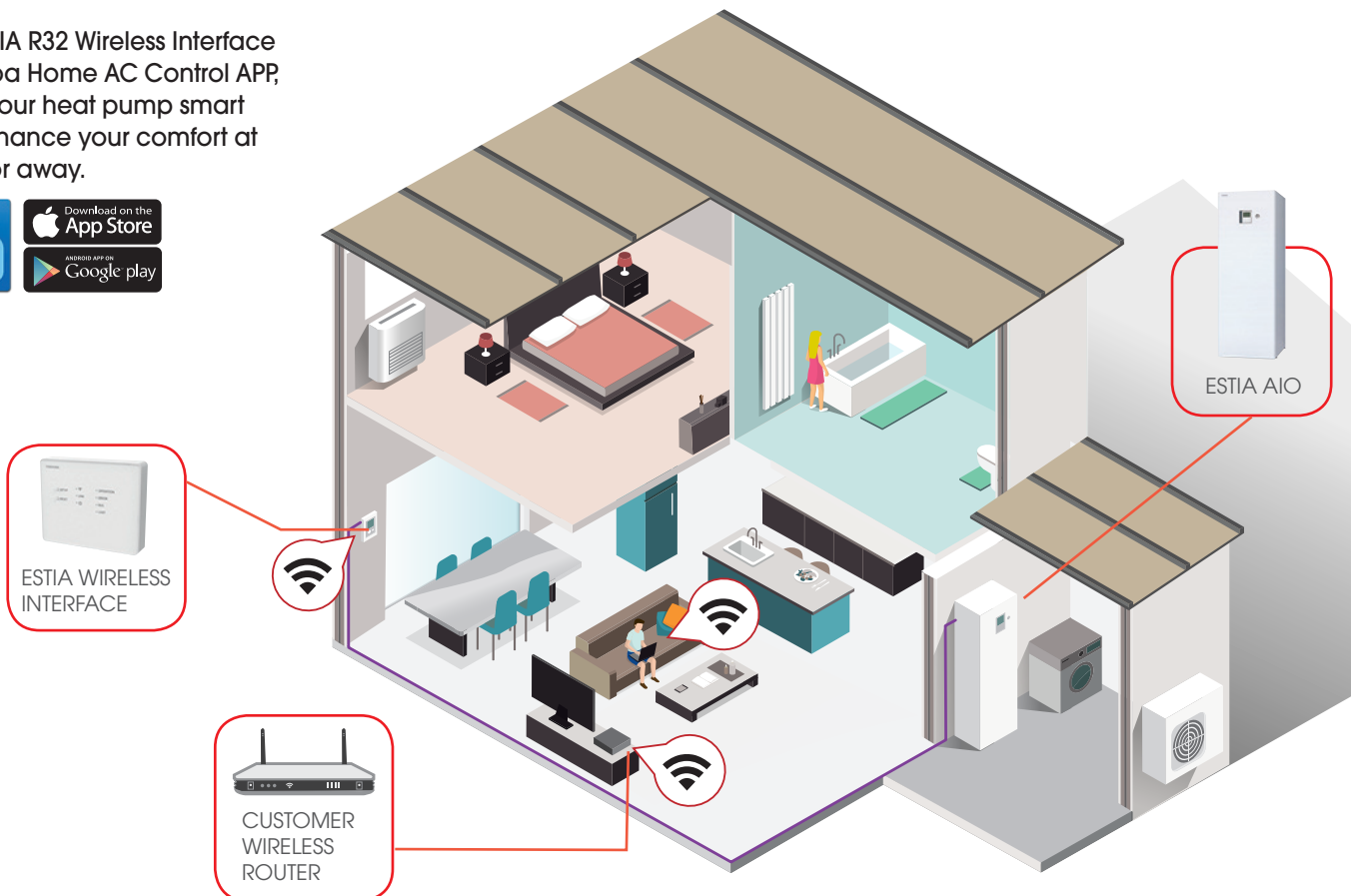



ESTIA SPLIT R410A & R32 – WALL MOUNTED & ALL-IN-ONE

OUTDOOR UNITS

Toshiba has a long and successful experience in the production of air-to-air heat pumps. The same reliable and award-winning technology is also at the core of these new air-to-water heat pumps benefiting from the advanced inverter technology and the Toshiba DC twin-rotary compressor. ESTIA heat pumps operate with the reliable and safe R410A & R32 low GWP refrigerants.



HYDRO UNITS

Compact and silent outdoor units are associated with hydraulic modules on the indoor side: refrigeration connections to ease the installation.

ESTIA hydro modules are available in three versions:

- All-In-One with integrated DHW cylinder 1 zone: Space heating & cooling, DHW production.
- All-In-One with integrated DHW cylinder 2 zones: Dual-zone space heating & cooling, DHW production.
- Wall-mounted hydraulic module: Space heating & cooling provided with a compact module installed on the wall. DHW production possibility thanks to a remote tank.



HOT WATER TANK

The ESTIA tank is a compact stainless steel insulated tank producing domestic hot water for sanitary use.

The performance of the overall system is also maximised thanks to the integrated coaxial heat exchanger.

The internal electric heater is controlled to optimise the use of the system in the case of extreme outdoor air temperatures. This solution reduces running costs and guarantees a constant hot water temperature inside the tank.

CONTROLLER 2 zones with weekly timer



The large screen remote controller is designed to be simple, intuitive and easy to use.

The remote controller allows independent heating to a maximum of 2 zones and domestic hot water.

It regulates the water temperature and optimises the systems energy consumption. The anti-bacteria control and the hot water boost functions can easily be activated.

The remote controller can also be used to set weekly timers for the system and, when used as a second remote controller, can be used to control room air temperature.

Leading energy efficiency A+++/A++ with COP up to 5.20 rated conditions.

With its best-in-class COP performance, the ESTIA air-to-water heat pump system delivers more heating power with less energy consumption. With the Toshiba advanced inverter, Estia air-to-water heat pump system only delivers the heating capacity required, thus reducing the amount of electricity used and the running costs of the heating system.

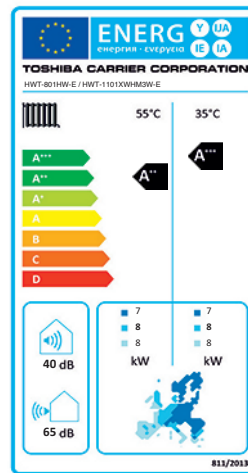

ESTIA Space Heating Energy Label

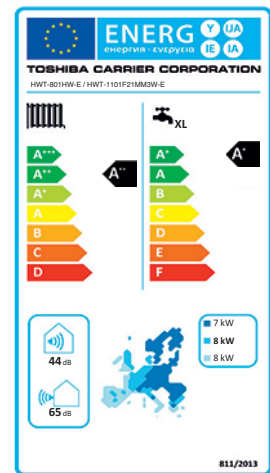

ESTIA combination & heater (with Domestic Hot Water) Energy Label

ESTIA DOMESTIC HOT WATER HEAT PUMP

The best energy savings for sanitary hot water production throughout the year

Toshiba DHW-HP is providing best in class performances on the market with:

- A+ Energy Label Class
- High COP 3.69 according to EN16147
- Very low noise level and Silent function
- Variable air flow rate & high ESP fan up to 200 Pa
- Hot water production up to 65°C

The Toshiba DHW-HP provides 80% energy savings Vs traditional electric water heaters with best in class COP 3.69 (EN16147 LCIE certified). Compatible with solar systems (photovoltaic panels ready or solar built-in extra coil), and smart grid ready, makes it the best solution for increased energy savings.

The innovative and adaptive controller is user friendly with 5 operational modes AUTO, ECO, BOOST, SILENT and HOLIDAY.

Toshiba DHW-HP offers flexible control solutions with low electricity tariff mode, energy consumption display, Smart grid ready, Modbus connectivity, Air Cooling function & Floor Heating function with extra coil.

Toshiba DHW-HP is particularly reliable thanks to its anti-corrosion enamelled steel tank with magnesium anode. The electrical heater back-up provides hot water at any time.



ONE SYSTEM,
FULL COMBINATIONS FLEXIBILITY

For new houses or refurbishment projects ESTIA heat pumps offer a variety of combinations. Some examples are shown below:

1 Space heating with domestic hot water

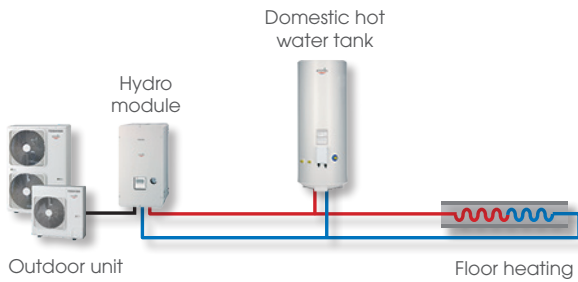

1 Space heating/cooling with domestic hot water

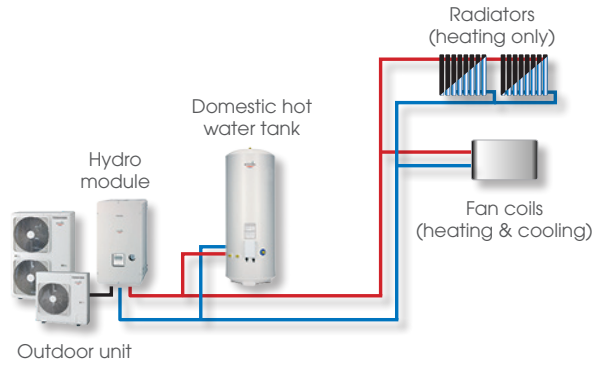

2 Space heating with domestic hot water

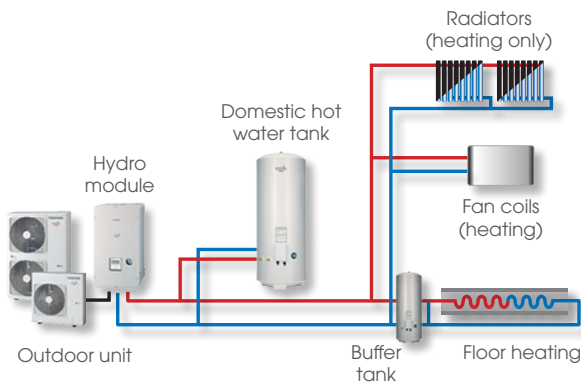

2 Space heating with domestic hot water & backup boiler

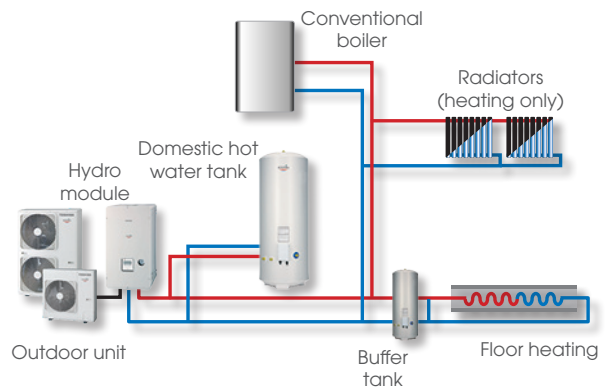

2 Space heating/cooling (multiple zones) with domestic hot water & solar panels

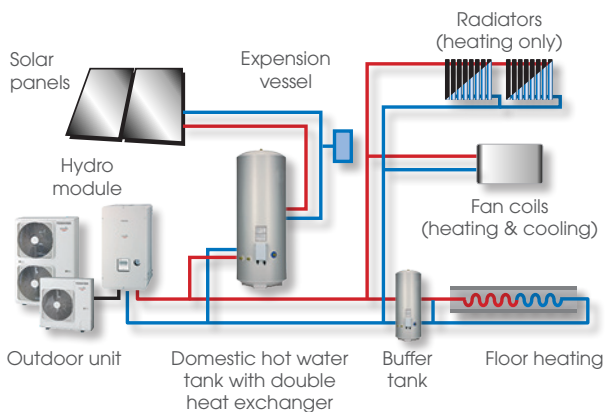

2 Space heating/cooling (multiple zones) with domestic hot water

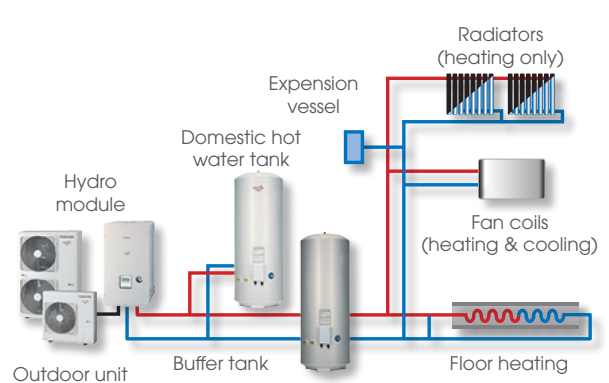

In existing dwellings already equipped with traditional gas or fuel boilers, the Toshiba ESTIA air-to-water heat pump system can be combined with the existing heating system to fully cover and optimise all heating needs, all year round. The boiler is then only used as a back-up source during some extreme weather days during the winter. The intelligent Toshiba control balances the energy source in the most efficient way.

Toshiba offers different control solutions to meet end users' and designers' expectations. From local individual control and settings to computer-based TCC-Link network, all indoor units can be programmed and set to suit the operational needs. Remote control systems offer a wide range of features including schedule timers, diagnostic functions, input/output signals, to name a few.

Toshiba offers a number of local control products that can be used to control a single indoor unit, or group of up to 8 indoor units, from a position adjacent to that indoor unit or group. It is possible to install these local controllers up to 500 m from the connected indoor unit which allows greater flexibility when designing the installation site.

2 Zone & 2 water pump control

Space heating/cooling (multiple zones) with domestic hot water.

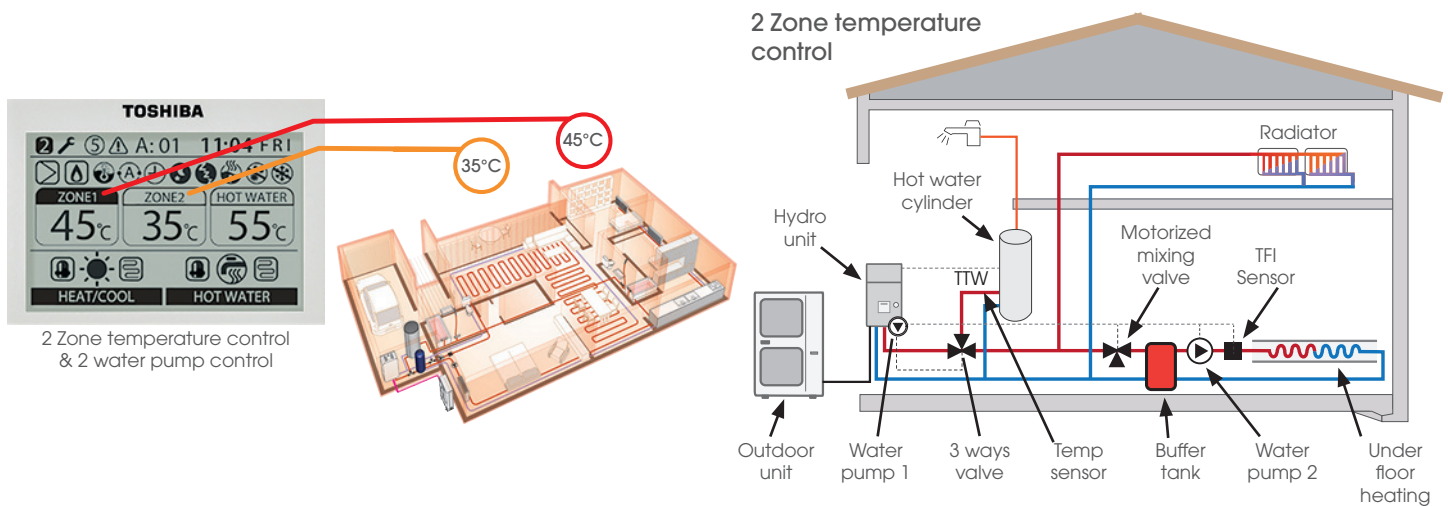

Control integration

ESTIA Master/Slave group control function allows up to 2 remote controllers to operate simultaneously up to 8 systems ESTIA Open protocol interfaces Modbus & KNX are available in Home Energy Management Systems.

Group control function

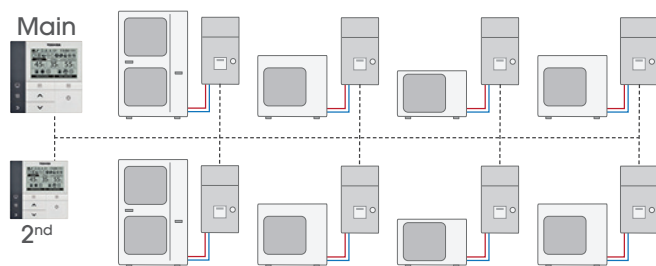

One remote controller can operate simultaneously up to 8 systems

Note: Maximum connections configuration: 8 outdoors and 2 remote controllers

Open protocol interfaces

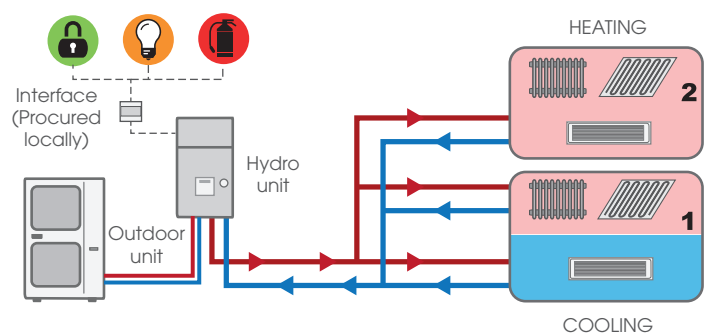

Modbus and KNX interfaces are available to use in Home Energy Management Systems

HWT-HW
ESTIA SPLIT R32 – ALL-IN-ONE



ESTIA R32 All-In-One air-to-water reversible Heat Pumps provide space heating or comfort cooling throughout the year, with an integrated 210L Domestic Hot Water cylinder. They are ideal for new constructions and renovation.

High energy efficiency for superior energy savings

- A+++/A++ energy class in space heating low & medium temperature with part load efficiency η_s up to 183%.
- A+ energy class in domestic hot water production with part load efficiency η_s dhw up to 136%.

Silent operation

- Silent outdoor unit down to 32dB(A) at 5m: No noise pollution for the neighborhoods.
- Silent indoor unit only 30 dB(A) at 1m.

Easy to install, easy to control

- Very compact outdoor unit (1 fan technology).
- Floor standing All-In-One hydro module 600x670mm footprint for easy integration.
- Second-zone kit factory fitted for easy management of two different leaving water temperatures (under floor heating & radiators).
- All components accessible on the facade: simplified access for installation and maintenance.
- Large screen remote controller, intuitive and easy to use.
- Power consumption display.
- Compatible with the latest generations of connected thermostats.
- Remote control via smartphones: Wireless interface option compatible with the Toshiba Home AC Control App.

COP MAX 5.20	CAPACITY 4kW > 11kW	OPERATION -25°C > +43°C	HOT WATER +20°C > +65°C
-----------------------------------	---	---	---

Best in class performances:

- > **Toshiba Twin Rotary compressors** & inverter technology, with injection technology on sizes 8 & 11kW
- > **65°C maximum leaving water temperature** ideal for renovation and boiler replacement
- > **COP Domestic Hot Water up to 3.21** (EN16147)
- > Heat pump operation for **DHW production up to +43°C outside air temperature** to maximize energy savings
- > **Back-up heaters** 3kW or 6kW or 9kW



ESTIA



INDOOR UNITS

HWT-601F21SM3W-E
 HWT-601F21ST6W-E
 HWT-1101F21SM3W-E
 HWT-1101F21ST6W-E



OUTDOOR UNITS

HWT-401HW-E
 HWT-601HW-E



HWT-801H(R)W-E
 HWT-1105H(R)W-E



REMOTE CONTROLS

HWS-AMSU51-E

ESTIA SPLIT R32 – ALL-IN-ONE

ESTIA SPLIT R32 – ALL-IN-ONE Performance data PRELIMINARY DATA

Outdoor unit		HWT-	401HW-E	601HW-E	801H(R)W-E	801H(R)W-E	1105H(R)W-E	1105H(R)W-E		
Hydro unit combination		Air T°	Water T°	HWT-	601F21S**W-E	601F21S**W-E	1101F21S**W-E	1101F21M**W-E	1101F21S**W-E	1101F21M**W-E
Under floor heating	Max heating capacity	+7°C	35°C	kW	H	7.25	7.25	11.90	13.24	
	Nominal heating capacity (rated)	+7°C	35°C	kW	H	4.00	6.00	8.00	11.00	
	COP (rated)	+7°C	35°C	W/W	H	5.20	4.80	5.19	4.60	
	Energy Efficiency Class - Average Climate - Low LWT		35°C		H	A+++	A+++	A+++	A+++	
	ETAs h (ηs) - Average Climate - Low LWT		35°C		H	178	180	182	179	
	SCOP - Average Climate - Low LWT		35°C		H	4.53	4.58	4.63	4.55	
	Max heating capacity	-7°C	35°C	kW	H	4.8	6.06	8.11	9.10	
	Heating capacity (1)	-7°C	35°C	kW	H	4.25	5.26	7.21	7.95	
	COP (1)	-7°C	35°C	W/W	H	3.06	2.97	2.70	2.54	
	Max heating capacity	-10°C	35°C	kW	H	4.40	5.57	7.49	8.45	
	Max heating capacity	-15°C	35°C	kW	H	3.73	4.75	6.46	7.37	
	Heating capacity (1)	-15°C	35°C	kW	H	3.43	4.39	5.96	6.77	
	COP (1)	-15°C	35°C	W/W	H	2.54	2.56	2.40	2.27	
Radiators heating & DHW	Energy Efficiency Class - Average Climate - Medium LWT		55°C			A++	A++	A++	A++	
	ETAs h (ηs) - Average Climate - Medium LWT		55°C			135	132	142	142	
	SCOP - Average Climate - Medium LWT		55°C			3.45	3.37	3.63	3.62	
	Max heating capacity	+7°C	45°C	kW	H	6.97	6.97	11.75	12.41	
	Max heating capacity	-7°C	45°C	kW	H	4.48	5.8	8.00	8.44	
	Max heating capacity	-15°C	45°C	kW	H	3.37	4.03	6.54	7.52	
	Max heating capacity	+7°C	55°C	kW	H	6.51	7.53	9.96	10.17	
	Max heating capacity	-7°C	55°C	kW	H	4.31	5.42	7.35	7.72	
	Max heating capacity	-10°C	55°C	kW	H	-	-	7.00	7.38	
	Max heating capacity	-15°C	55°C	kW	H	-	-	6.41	6.81	
Cooling	Cooling capacity nominal		35°C	7/12°C	kW	C	4.00	5.00	6.00	8.00
	EER nominal				W/W	C	3.45	3.3	3.2	2.8
	Cooling capacity		35°C	18/23°C	kW	C	6.34	7.12	8.85	10.26
	EER				W/W	C	4.37	3.91	3.86	3.35

Max heating capacities are shown at peak value during operation, at max compressor operating range in accordance with EN14511. Nominal heating capacities are given at water delta T° 5°C and rated compressor operating frequency in accordance with EN14511. (1) Heating capacity at -7°C are shown at max compressor operating frequency in accordance with EN14511. Energy Efficiencies Class & Seasonal space heating energy efficiency (ηs) are provided for Average Climate conditions in accordance with EN14825.

ESTIA SPLIT R32 – ALL-IN-ONE Physical data outdoor

Outdoor unit	HWT-	401HW-E	601HW-E	801HW-E	1105HW-E	801HRW-E	1101HRW-E
Dimensions (HxWxD)	mm	630 x 800 x 300			1050 x 1010 x 370		
Weight	kg	42			75		
Sound power level (Rated) H/C	dB(A)	59/60	62/61	63/62	64/62	63/62	64/62
Sound power level (Silent Mode) H/C	dB(A)	54/55	58/57	58/59	62/60	58/59	62/60
Sound pressure level (Rated) H/C at 1m (1)	dB(A)	45/46	46/45	51/50	51/49	51/50	51/49
Sound pressure level (Silent Mode) H/C et 1m (1)	dB(A)	40/41	42/41	46/47	49/47	46/47	49/47
Sound pressure level (Rated) H/C at 5m (2)	dB(A)	37/38	40/39	41/40	42/40	41/40	42/40
Sound pressure level (Silent Mode) H/C at 5m (2)	dB(A)	32/33	36/35	36/37	40/38	36/37	40/38
Compressor type		DC Twin rotary			DC Twin rotary w/injection		
Refrigerant / Charge amount (kg)		R32 / 0.9			R32 / 1.25		
Flare connections (gas-liquid)		4/8" - 2/8"			5/8" - 2/8"		
Minimum pipe length	m	5			5		
Maximum pipe length (with Ref. charge)	m	30			30		
Maximum height difference	m	30			30		
Chargeless pipe length	m	20			8		
Operating range in space heating*	°C	-20 ~ 25			-25 ~ 25		
Operating range Domestic hot water	°C	-20 ~ 43			-25 ~ 43		
Operating range in cooling	°C	10 ~ 43			10 ~ 43		
Bottom plate heater power	W				75		
Power supply	V-ph-Hz				220/230-1-50		

* Depending on the conditions only back-up heater operates. ** Heater Operation in more than 35°C. (1) Noise pressure levels EN 12102 at 1m, open field directivity 2. (2) Noise pressure levels EN 12102 at 5m, open field directivity 2.

ESTIA SPLIT R32 – ALL-IN-ONE Physical data Hydro unit

Hydro unit	HWT-	601F21SM3W-E	601F21ST6W-E	1101F21SM3W-E	1101F21ST6W-E	1101F21ST9W-E	1101F21MM3W-E	1101F21MT6W-E	1101F21MT9W-E	
Outdoor unit	HWT-	401 & 601		801 & 1101						
Dimensions (HxWxD)	mm				1700 x 600 x 670					
Load Profile		L			XL					
DHW Energy Efficiency Class		A+			A+					
DHW ETA _{WH} (1 _{WH}) - Average Climate	%	136			130					
COP at Air7°C (EN16147)		3.21			3.12					
Heating time	Hrs	01h36			01h05					
Leaving water temperature (without electrical heater)	°C	H	20 ~ 55°C			20 ~ 65°C				
Maximum leaving water temperature (with electrical heater)	°C	H	20 ~ 55°C			20 ~ 65°C				
Leaving water temperature (cooling)	°C	C				7 ~ 25°C				
Tank	Water volume	L				210				
	Material					Enamelled				
	Maxium water pressure	bar				6				
Expansion vessel volume	L				10					
2 zone operation					Available					
Weight	Kg	157			162					
Sound power level	dB(A)	42			44					
Sound pressure level at 1m	dB(A)	30			32					
Electric back up heater capacity	kW	3.0	6.0	3.0	6.0	9.0	3.0	6.0	9.0	
Electric back up heater supply	V-ph-Hz	220 ~ 230-1-50		380 ~ 400-3N-50		220 ~ 230-1-50		380 ~ 400-3N-50		
Maximum current	A	13	13 x 2	13	13 x 2	13 x 3	13	13 x 2	13 x 3	

HWT-HW
ESTIA SPLIT R32 – WALL MOUNTED



ESTIA R32 wall-mounted air-to-water reversible Heat Pumps provide space heating or comfort cooling throughout the year. They are ideal for new constructions and renovation. They can be combined with a separated tank for domestic hot water production (150, 200 and 300L).

High energy efficiency for superior energy savings

- A+++/A++ energy class in space heating low & medium temperature with part load efficiency η_s up to 183%.
- A+/A energy class in domestic hot water production with part load efficiency η_s dhw up to 122%.

Silent operation

- Silent outdoor unit down to 32dB(A) at 5m: No noise pollution for the neighborhoods.
- Silent indoor unit only 28 dB(A) at 1m.

Easy to install, easy to control

- Very compact outdoor unit (1 fan technology).
- The most compact wall-mounted hydro module on the market for easy integration.
- All components accessible on the facade: Simplified access for installation and maintenance.
- Possible management of a second water pump for 2 zones.
- Large screen remote controller, intuitive and easy to use.
- Power consumption display.
- Compatible with the latest generations of connected thermostats.
- Remote control via smartphones: Wireless interface option compatible with the Toshiba Home AC Control App.

COP MAX 5.20	CAPACITY 4kW > 11kW	OPERATION -25°C > +43°C	HOT WATER +20°C > +65°C
-----------------------------------	---	---	---

Best in class performances:

- > **Toshiba Twin Rotary compressors** & inverter technology, with injection technology on sizes 8 & 11kW
- > **65°C maximum leaving water temperature** ideal for renovation and boiler replacement
- > **COP Domestic Hot Water up to 2.93** (EN16147)
- > Heat pump operation for **DHW production up to +43°C outside air temperature** to maximize energy savings
- > **Back-up heaters** 3kW or 6kW or 9kW



INDOOR UNITS

HWT-601XWHM3W-E
 HWT-601XWHT6W-E
 HWT-1101XWHM3W-E



OUTDOOR UNITS

HWT-401HW-E
 HWT-601HW-E



HWT-801H(R)W-E
 HWT-1105H(R)W-E



REMOTE CONTROLS

HWS-AMSU51-E



DOMESTIC HOT WATER TANK

HWS-1501CSHM3-E
 HWS-2101CSHM3-E
 HWS-3001CSHM3-E

ESTIA SPLIT R32 – WALL MOUNTED

ESTIA SPLIT R32 – WALL MOUNTED Performance data PRELIMINARY DATA

Outdoor unit	Air T°	Water T°	HWT- HWT-	401HW-E 601XWH**W-E	601HW-E 601XWH**W-E	801H(R)W-E 1101XWH**W-E	1105H(R)W-E 1101XWH**W-E
Under floor heating	Max heating capacity			7.25	7.25	11.90	13.24
	Nominal heating capacity (rated)			4.00	6.00	8.00	11.00
	COP (rated)			5.2	4.8	5.19	4.6
	Energy Efficiency Class - Average Climate - Low LWT			H	A+++	A+++	A+++
	ETAs h (ηs) - Average Climate - Low LWT			178	180	182	179
	SCOP - Average Climate - Low LWT			4.53	4.58	4.63	4.55
	Max heating capacity			4.80	6.06	8.11	9.10
	Heating capacity (1)			4.25	5.26	7.21	7.95
	COP (1)			3.06	2.97	2.70	2.54
	Max heating capacity			4.4	5.57	7.49	8.45
Radiators heating & DHW	Energy Efficiency Class - Average Climate - Medium LWT			A++	A++	A++	A++
	ETAs h (ηs) - Average Climate - Medium LWT			135	132	142	142
	SCOP - Average Climate - Medium LWT			3.45	3.37	3.63	3.62
	Max heating capacity			6.97	6.97	11.75	12.41
	Max heating capacity			4.48	5.80	8.00	8.44
	Max heating capacity			3.37	4.03	6.54	7.52
	Max heating capacity			6.51	7.53	9.96	10.17
	Max heating capacity			4.31	5.42	7.35	7.72
	Max heating capacity			-	-	7.00	7.38
	Max heating capacity			-	-	6.41	6.81
Cooling	Cooling capacity nominal			4.00	5.00	6.00	8.00
	EER nominal			3.45	3.3	3.2	2.8
	Cooling capacity			6.34	7.12	8.85	10.26
	EER			4.37	3.91	3.86	3.35

Max heating capacities are shown at peak value during operation, at max compressor operating range in accordance with EN14511. Nominal heating capacity are given at water delta T° 5°C and rated compressor operating frequency in accordance with EN14511. (1) Heating capacity at -7°C are shown at max compressor operating frequency in accordance with EN14511. Energy Efficiencies Class & Seasonal space heating energy efficiency (ηs) are provided for Average Climate conditions in accordance with EN14825.

ESTIA SPLIT R32 – WALL MOUNTED Physical data outdoor

Outdoor unit	HWT- HWT-	401HW-E 630 x 800 x 300	601HW-E 630 x 800 x 300	801HW-E 1050 x 1010 x 370	1101HW-E 1050 x 1010 x 370	801HRW-E 1050 x 1010 x 370	1101HRW-E 1050 x 1010 x 370
Dimensions (HxWxD)	mm	630 x 800 x 300		1050 x 1010 x 370		1050 x 1010 x 370	
Weight	kg	42		75		75	
Sound power level (Silent Mode) H/C	dB(A)	54/55	58/57	58/59	62/60	58/59	62/60
Sound pressure level (Rated) H/C at 1m (1)	dB(A)	45/46	46/45	51/50	51/49	51/50	51/49
Sound pressure level (Silent Mode) H/C at 1m (1)	dB(A)	40/41	42/41	46/47	49/47	46/47	49/47
Sound pressure level (Rated) H/C at 5m (2)	dB(A)	37/38	40/39	41/40	42/40	41/40	42/40
Sound pressure level (Silent Mode) H/C at 5m (2)	dB(A)	32/33	36/35	36/37	40/38	36/37	40/38
Compressor type		DC Twin rotary		DC Twin rotary w/injection			
Refrigerant / Charge amount (kg)		R32 / 0.9		R32 / 1.25			
Flare connections (gas-liquid)		4/8" - 2/8"		5/8" - 2/8"			
Minimum pipe length	m	5		5			
Maximum pipe length (with Ref. charge)	m	30		30			
Maximum height difference	m	30		30			
Chargeless pipe length	m	20		8			
Operating range in space heating*	°C	-20 ~ 25		-25 ~ 25			
Operating range Domestic hot water	°C	-20 ~ 43		-25 ~ 43			
Operating range in cooling	°C			10 - 43			
Bottom tape heater power	W			75			
Power supply	V-ph-Hz			220/240-1-50			

* Depending on the conditions only back-up heater operates. ** Heater Operation in more than 35°C. (1) Noise pressure levels EN 12102 at 1m, open field directivity 2. (2) Noise pressure levels EN 12102 at 5m, open field directivity 2.

ESTIA SPLIT R32 – WALL MOUNTED Physical data Hydro unit

Hydro unit	HWT- HWT-	601XWHM3W-E 401 & 601	601XWHT6W-E 401 & 601	1101XWHM3W-E 801 & 1101	1101XWHT6W-E 801 & 1101	1101XWHT9W-E 801 & 1101
Leaving water temperature (without electrical heater)	°C	20 ~ 55°C		20 ~ 65°C		
Maximum leaving water temperature (with electrical heater)	°C	55		65		
Leaving water temperature (cooling)	°C	C		7 ~ 25°C		
Dimensions (HxWxD)	mm	725 x 450 x 235				
Weight	Kg	27				
Sound power level	dB(A)	40				
Sound pressure level at 1m	dB(A)	28				
Electric back up heater capacity	kW	3.0		6.0		9.0
Electric back up heater supply	V-ph-Hz	220-240-1-50		380-415-3N-50		380-415-3N-50
Maximum current	A	13		13		13 x 3

ESTIA SPLIT R32 – WALL MOUNTED Physical data Sanitary Hot Water tank

Domestic hot water tank	HWS- HWT-	1501CSHM3-E 401 & 601	2101CSHM3-E 801 & 1101	3001CSHM3-E 401 & 601	3001CSHM3-E 801 & 1101
Water volume	litres	150		300	
Load Profile		L		XL	
DHW Energy Efficiency Class		A+	A+	A	A
DHW ETA _{WH} (η _{WH}) - Average Climate	%	120	115	115	122
COP at Air7°C (EN16147)		2,87	2,72	2,72	2,93
Material		Stainless steel			
Maximum water pressure	bar	6			
Max water temperature	°C	75			
Electric heater	kW	2.7			
Power supply	V-ph-Hz	220/240-1-50			
Height	mm	1 090		1 474	
Diameter	mm			550	
Weight	Kg	31		41	

HWS_XWH
ESTIA SPLIT S5



The Toshiba air to water heat pump split system is designed to deliver the right temperature for space heating and produce domestic sanitary hot water throughout the year. The ESTIA system has the additional advantage of providing cooling in the warmer seasons.

High Energy efficiency providing enhanced energy savings

A++ / A++ energy class in space heating & combination heater. Part Load efficiency η_s up to 163% according to EF14511 & EN14825.

The Toshiba Inverter uses the new vector controlled Intelligent Power Drive Unit, which enables a wider range of compressor frequencies resulting in better temperature control.

Easy to install, easy to control

Quick and easy to install, the ESTIA hydro module unit can be placed safely in the most suitable place within the house.

Its large screen remote controller is designed to be simple, intuitive and easy to use. ESTIA is compatible with latest generations of connected thermostat.

COP MAX 4.90	CAPACITY 4.5kW >16kW	OPERATION -20°C > +43°C	HOT WATER +40°C > +75°C
-----------------------------------	--	---	---

Best in class performances:

- > Max **COP 4.90 @+7°C & 3.08 @-7°C** air temperature
- > Heating operation down to -20°C
- > Domestic sanitary hot water +40°C to +75°C
- > Master/Slave group control up to 8 units



INDOOR UNITS

- HWS-455XWHM3-E
- HWS-805XWHM3-E
- HWS-805XWHT6-E
- HWS-1405XWHM3-E
- HWS-1405XWHT6-E
- HWS-1405XWHT9-E



OUTDOOR UNITS

- HWS-455H-E
- HWS-805H-E
- HWS-1105H-E
- HWS-1405H-E
- HWS-1105H8-E
- HWS-1405H8-E
- HWS-1605H8-E



REMOTE CONTROLS

- HWS-AMS54E



DOMESTIC HOT WATER TANK

- HWS-1501CSHM3-E
- HWS-2101CSHM3-E
- HWS-3001CSHM3-E

HWS-(P)_XWH
ESTIA SPLIT S5 POWERFUL







The Toshiba air to water heat pump split system is designed to deliver the right temperature for space heating and produce domestic sanitary hot water throughout the year. The ESTIA system has the additional advantage of providing cooling in the warmer seasons.

High Energy efficiency providing enhanced energy savings
 A++ / A++ energy class in space heating & combination heater. Part Load efficiency ηs up to 175% according to EF14511 & EN14825.

The Toshiba Inverter uses the new vector controlled Intelligent Power Drive Unit, which enables a wider range of compressor frequencies resulting in better temperature control.

Easy to install, easy to control
 Quick and easy to install, the ESTIA hydro module unit can be placed safely in the most suitable place within the house.

Its large screen remote controller is designed to be simple, intuitive and easy to use. ESTIA is also compatible with latest generations of connected thermostat.

COP MAX  4.88	CAPACITY  16kW >18kW	OPERATION  -25°C > +43°C	HOT WATER  +40°C > +75°C
---	--	--	--

Best in class performances:

- > Max **COP 4.88 @+7°C & COP 2.67 @-7°C** air temperature
- > **Maintain rated capacity down to -15°C**
- > Heating operation down to **-25°C**
- > Domestic sanitary hot water **+40°C to +75°C**
- > Master/Slave group control up to 8 units



INDOOR UNITS

- HWS-P805XWHM3-E
- HWS-P805XWHT6-E
- HWS-P805XWHT9-E
- HWS-P1105XWHM3-E
- HWS-P1105XWHT6-E
- HWS-P1105XWHT9-E



OUTDOOR UNITS

- HWS-P805H8R-E
- HWS-P1105H8R-E
- HWS-P1405H8R-E
- HWS-P805HR-E
- HWS-P1105HR-E



REMOTE CONTROLS

- HWS-AMS54E



HOT WATER TANK

- HWS-1501CSHM3-E
- HWS-2101CSHM3-E
- HWS-3001CSHM3-E

ESTIA SPLIT S5 POWERFUL

ESTIA SPLIT S5 POWERFUL Performance data

Outdoor unit		HWS-	P805HR-E	P1105HR-E	P805H8R-E	P1105H8R-E	P1405H8R-E			
Hydro unit combination	Air T°	Water T°	HWS-	P805XWH**E	P1105XWH**E	P805XWH**E	P1105XWH**E			
Under floor heating	Max heating capacity	+7°C	35°C	kW	H	16.92	18.05	14.67	14.95	15.1
	Nominal heating capacity	+7°C	35°C	kW	H	8.00	11.20	8.00	11.20	14.00
	COP	+7°C	35°C	W/W	H	4.76	4.88	4.68	4.8	4.44
	Energy Efficiency Class - Low Temp (Ecodesign LOT1-2015)		35°C	H	A++	A++	A++	A++	A++	
	Energy Efficiency Class - Low Temp (Ecodesign LOT1-Sept2019)		35°C		A++	A+++	A++	A++	A++	
	Seasonal space heating energy efficiency (ηs)		35°C	H	157%	175%	169%	173%	173%	
	Seasonal space heating energy efficiency (SCOP)		35°C	H	4.01	4.48	4.31	4.43	4.43	
	Max heating capacity	-7°C	35°C	kW	H	11.92	12.79	10.82	11.62	13.44
	Heating capacity ⁽¹⁾	-7°C	35°C	kW	H	9.38	9.74	9.45	10.3	12.21
	COP	-7°C	35°C	W/W	H	2.67	2.64	2.81	2.39	2.53
Radiators heating & DHW	Max heating capacity	-15°C	35°C	kW	H	9.37	11.23	8.18	9.26	10.7
	Heating capacity ⁽¹⁾	-15°C	35°C	kW	H	7.26	8.06	7.77	8.75	8.91
	COP	-15°C	35°C	W/W	H	2.18	2.18	2.33	2.26	2.05
	Max heating capacity	+7°C	45°C	kW	H	14.00	14.74	16.32	15.32	16.05
	Max heating capacity	-7°C	45°C	kW	H	10.16	10.61	9.08	10.01	11.43
	Max heating capacity	-15°C	45°C	kW	H	8.04	8.13	6.82	7.71	7.96
	Max heating capacity	-20°C	45°C	kW	H	6.72	7.64	5.98	7.80	8.05
	Max heating capacity	+7°C	55°C	kW	H	11.08	11.43	15.04	15.69	16.97
	Max heating capacity	-7°C	55°C	kW	H	8.40	8.42	9.41	10.93	12.37
	Energy Efficiency Class - Medium Temp (Ecodesign LOT1-2015)		55°C	H	A++	A++	A+	A++	A++	
Cooling	Energy Efficiency Class - Low Temp (Ecodesign LOT1-Sept 2019)		55°C		A++	A++	A+	A++	A++	
	Seasonal space heating energy efficiency (ηs)		55°C	H	125%	131%	123%	130%	130%	
	Seasonal space heating energy efficiency (SCOP)		55°C	H	3.22	3.38	3.16	3.35	3.34	
	Nominal cooling capacity	35°C	7°C	kW	C	3.22	3.38	3.16	3.35	3.34
EER			W/W	C	3.66	3.00	3.66	3.00	2.82	

Max heating capacities are shown at peak value during operation, at max compressor operating range in accordance with EN14511

Nominal heating capacity are given at water delta T° 5°C and rated compressor operating frequency in accordance with EN14511

(1) Heating capacity at -7°C are shown at max compressor operating frequency in accordance with EN14511

Energy Efficiencies Class & Seasonal space heating energy efficiency (ηs) are provided for Average Climate conditions in accordance with EN14825

ESTIA SPLIT S5 POWERFUL Physical data outdoor unit

Outdoor unit		HWS-	P805HR-E	P1105HR-E	P805H8R-E	P1105H8R-E	P1405H8R-E
Dimensions (HxWxD)	mm		1340x900x320	1340x900x320	1340x900x320	1340x900x320	1340x900x320
Weight	kg		92	92	94	94	94
Sound pressure level (max) ⁽²⁾	dB(A)		51	51	52	52	53
Sound power level (max)	dB(A)		66	66	66	67	68
Compressor type			DC Twin rotary	DC Twin rotary	DC Twin rotary	DC Twin rotary	DC Twin rotary
Refrigerant			R410A	R410A	R410A	R410A	R410A
Refrigerant charge	kg		2.70	2.70	2.70	2.70	2.70
Flare connections (gas-liquid)			5/8" - 3/8"	5/8" - 3/8"	5/8" - 3/8"	5/8" - 3/8"	5/8" - 3/8"
Minimum pipe length	m		5	5	5	5	5
Maximum pipe length	m		30	30	30	30	30
Maximum height difference	m		30	30	30	30	30
Chargeless pipe length	m		30	30	30	30	30
Operating range in space heating*	°C		-25~25	-25~25	-25~25	-25~25	-25~25
Operating range domestic hot water	°C		-25~43**	-25~43**	-25~43**	-25~43**	-25~43**
Operating range in cooling	°C		10~43	10~43	10~43	10~43	10~43
Bottom tape heater power	W		75	75	75	75	75
Power supply	V-ph-Hz		220/230-1-50	220/230-1-50	380/400-3-50	380/400-3-50	380/400-3-50

* Depending on the conditions only back-up heater operates. ** Heater Operation in more than 35°C.

(2) Measurement position: Front = 1m, Height = 1.5m

ESTIA SPLIT S5 POWERFUL Physical data hydro unit

Hydro unit		HWS-	P805XWHM3-E	P805XWHM6-E	P805XWHM9-E	P1105XWHM3-E	P1105XWHM6-E	P1105XWHM9-E
To be used with size			80	80	80	110	110	110
Leaving water temperature (heating)	°C	H	20~60°C	20~60°C	20~60°C	20~60°C	20~60°C	20~60°C
Leaving water temperature (cooling)	°C	C	7~25°C	7~25°C	7~25°C	7~25°C	7~25°C	7~25°C
Dimensions (HxWxD)	mm		925x525x355	925x525x355	925x525x355	925x525x355	925x525x355	925x525x355
Weight	Kg		49**	49**	49**	52**	52**	52**
Sound pressure level	dB(A)		29	29	29	32	32	32
Sound power level	dB(A)		41	41	41	43	43	43
Electric back up heater capacity	kW		3	6	9	3	6	9
Electric back up heater supply	V-ph-Hz		220~230-1-50	380~400-3N-50	380~400-3N-50	220~230-1-50	380~400-3N-50	380~400-3N-50
Maximum current	A		13	13 x 2	13 x 3	13	13 x 2	13 x 3

ESTIA SPLIT S5 POWERFUL Physical data sanitary hot water tank

Domestic hot water tank		HWS-	1501CSHM3-E	2101CSHM3-E	3001CSHM3-E
Water volume	litres		150	210	300
Max water temperature	°C		75	75	75
Electric heater	kW		2.7	2.7	2.7
Power supply	V-ph-Hz		220/230-1-50	220/230-1-50	220/230-1-50
Height	mm		1 090	1 474	2 040
Diameter	mm		550	550	550
Weight	Kg		31	41	60
Cylinder Material			Stainless steel	Stainless steel	Stainless steel

ACCESSORIES

Model name	Description	Functions
TCB-PCIN3E	Output signal PCB	Boiler operation output signal. Alarm output signal. Defrost output signal. Compressor operation output signal
TCB-PCMO3E	Input signal PCB	Room thermostat input. Emergency stop input
HWS-AMS54E	Wired RC	Wired Remote controller(sub)



HWS-G_CNMRE
ESTIA DOMESTIC HOT WATER HEAT PUMP



The Toshiba DHW-HP is designed to provide the customer with best in class performance and energy savings, for sanitary hot water production, throughout the year. Thanks to its large operating range, high external static pressure fan and low noise operation the Toshiba DHW-HP is suitable for all types of installation.

Comfort & ease of installation

- Sanitary hot water can be produced throughout the year, using only the heat pump, thanks to the innovative design of the unit and the large operating temperature range (Air -7°C to +40°C). Installation is simplified due to the slimline chassis design (Ø603mm) and easy access to water pipe connections.

Highest efficiency for best energy savings

- The Toshiba DHW-HP provides 80% energy savings Vs traditional electric water heaters with best in class COP 3.69 (EN16147 LCIE certified). Compatible with solar systems (photovoltaic panels ready or solar built-in extra coil), and smart grid ready, makes it the best solution for increased energy savings.

Innovative & reliable

- Anti-corrosion protection with enamelled steel tank and magnesium anode. Back-up electrical heater to secure hot water production at any time.

Intuitive & adaptive control

- User friendly control with 5 operational modes AUTO, ECO, BOOST, SILENT and HOLIDAY. Flexible control solutions: Low electricity tariff mode, energy consumption display, Modbus connectivity, Air Cooling function & Floor Heating function with extra coil.

COP MAX	OPERATION	HOT WATER
3.69	-7°C > +40°C	Up to 65°C

Best in class performances:

- > Energy class A+ (ErP 2017)
- > Heat pump hot water production from -7°C to +40°C outside air temperature
- > Hot water temperature to 60°C without the use of electric heaters
- > Adjustable airflow rate (0-800m³/h)
- > Best in class fan external static pressure (up to 200Pa)
- > Low noise operation
- > Slimline chassis design (Ø603mm)
- > Flexible control options including Modbus connectivity
- > Compatible with other renewable technologies solar thermal and solar photovoltaic (advanced option only)
- > Smart Grid Ready (advanced option only)



DHW-HP UNITS

HWS-G190
HWS-G260



REMOTE CONTROLS

DHW-HP
Control panel

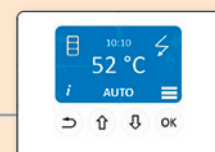

ESTIA DOMESTIC HOT WATER HEAT PUMP

ESTIA DOMESTIC HOT WATER HEAT PUMP Performance data

Domestic Hot Water Heat Pump		HWS-G1901CNMR-E	HWS-G2601CNMR-E
Energy Class	Label	A+	A+
η_{WH}	%	146	150
COP at Air7°C W10°C-52,9°C (EN16147)		3,57	3,69
COP at Air15°C W10°C-52,9°C (EN16147)		3,90	3,87
Heat pump operating range (min/max)	°C	-7 / +40	-7 / +40
Heat up time (A7°C W10°C-53,5°C)	hr:mm	06:27	09:12
Maximum quantity of usable hot water Vmax 40 volume (W52.9°C)	liters	247	347
Cylinder volume	liters	190	260
Cylinder profile		L	XL
Maximum water temperature (heat pump & elect.heater)	°C	65	65
Maximum water temperature (heat pump only)	°C	60	60
Corrosion protection		Magnesium anode	Magnesium anode
Noise power level - Ducted (ISO12102)	dB(A)	49.0	49.0
Noise pressure level @2m - Ducted	dB(A)	32.0	32.0
Noise power level - Non ducted (ISO12102)	dB(A)	55.6	55.6
Noise pressure level @2m - Non ducted	dB(A)	38.6	38.6
Airflow rate nominal (min - max)	m³/h	450 (0 - 800)	450 (0 - 800)
Maximum fan power	W	85	85
Maximum external static pressure	Pa	200	200
Air duct connections	mm	160	160
Minimum room volume (non ducted unit)	m³	60	60
Maximum power input	W	2185	2185
Electrical heater power	W	1500	1500
Maximum compressor power	W	600	600
Auxiliary power input (Paux)	W	1.61	1.61
Standby power input (Pes)	W	17	20

ESTIA DOMESTIC HOT WATER HEAT PUMP Physical data

Domestic Hot Water Heat Pump		HWS-G1901CNMR-E	HWS-G2601CNMR-E
Dimensions (Height x Diameter)	mm	1600 x 620	1600 x 620
Required height for installation	mm	1868	2223
Weight (dry / wet)	kg	94 / 284	100/350
Refrigerant		R134A	R134A
Refrigerant charge	kg	1.2	1.28
Refrigerant charge CO₂ equivalent	ton	1.72	1.83
Water connections (cold & hot water)	inch	3/4	3/4
Standard water connection entry angle	deg.	45	45
Condensates water connections	mm	Diam19	Diam19
Max water side operating pressure	Mpa	0.6	0.6
Power supply	V-ph-Hz	230-1-50	230-1-50

(1) Sound pressure calculation based on spherical sound propagation and infinite room (directivity factor Q=1)

ESTIA DOMESTIC HOT WATER HEAT PUMP Product configurations

Description	Model name	Functions
190l cylinder + 180°C variant water connection position	HWS-G1901CNRR-E	Alternative water connection entry position for flexible installation
190l cylinder + deluxe PCB	HWS-G1901CNXR-E	Deluxe PCB option allowing connection of: - Solar Photovoltaic - Smart Grid Ready - Additional pump / ventilation damper
190l cylinder + deluxe PCB + heating coil	HWS-G1901ENXR-E	All of the features of the deluxe PCB option with the additional benefit of connection to a solar thermal system
260l cylinder + 180°C variant water connection position	HWS-G2601CNRR-E	Alternative water connection entry position for flexible installation
260l cylinder + deluxe PCB	HWS-G2601CNXR-E	Deluxe PCB option allowing connection of: - Solar Photovoltaic - Smart Grid Ready - Additional pump / ventilation damper
260l cylinder + deluxe PCB + heating coil	HWS-G2601ENXR-E	All of the features of the deluxe PCB option with the additional benefit of connection to a solar thermal system

ON YOUR OWN AS A FAMILY IN A GROUP ON YOUR OWN



In 1981, Toshiba was the first company to incorporate inverter technology into air conditioning systems. Ever since, it has retained its technological advantage over its competitors. Its development of the new and exclusive DC hybrid inverter system has reaffirmed its ability to innovate and remain a technological leader, even in fast-growing markets. But for Toshiba, innovation also involves working alongside international institutions that carefully evaluate the impact of new technologies on our environment. Toshiba combines technological development with concern for future generations, resulting in a range of extremely energy-efficient air conditioners, which reduce greenhouse gas emissions at the source. Toshiba's continuous research led to the development of PWM (Pulse Width Modulation) technology, which is used in combination with traditional PAM (Pulse Amplitude Modulation) control. The application of these two distinct technologies enables total control of performance and energy use.

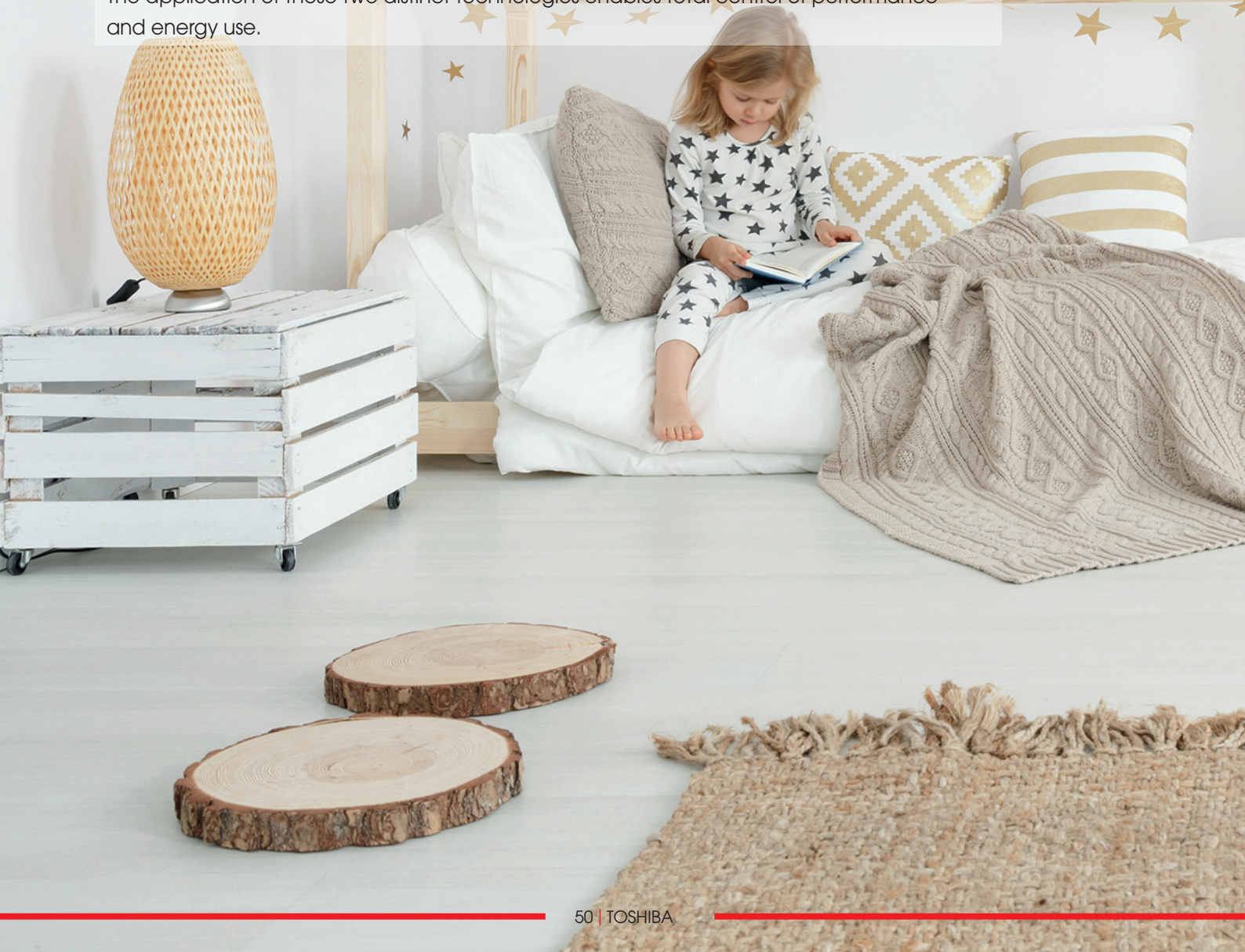

RESIDENTIAL
AIR-TO-AIR

AS A FAMILY IN A GROUP ON YOUR OWN AS A FAMILY

> HIGH WALLS & CONSOLES



When technology meets comfort

> Innovation, efficiency, high reliability, energy savings, environmental respect ...

These are the powerful values at the heart of Toshiba's DNA. For over 50 years Toshiba has been providing its clients with the guaranteed accuracy and expertise of flawless Japanese quality. Technological, stylish, highly efficient and environmentally-friendly, the Toshiba monosplit units proudly uphold the values rooted firmly in its name.

> **The development of the new and exclusive DC hybrid inverter system** has reaffirmed this ability to innovate and maintain technological leadership in a fast-growing market. But for Toshiba, innovation also means a strong commitment to international institutions that carefully evaluate the impact of new technologies on our environment. Toshiba combines technological development with care for future generations: the result is a range of extremely energy-efficient air conditioners, reducing greenhouse gas emissions at source.

Toshiba continuous research into the development of PWM technology, which together with the traditional PAM control, allows total control of the systems performance and energy usage.

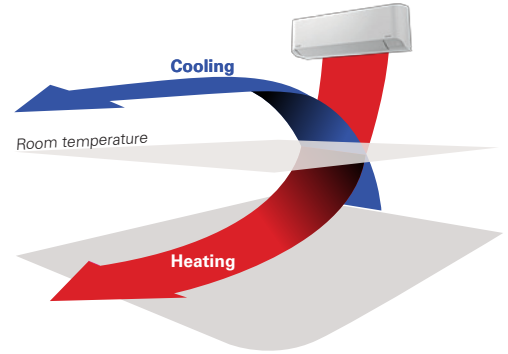

The new Hybrid Inverter features PAM (Pulse Amplitude Modulation) for the highest levels of power.



PWM (Pulse With Modulation) for energy efficiency.

The Future Is Now

> Energy efficiency by design

Toshiba products are designed to optimise energy performance at any time of year. This in turn reduces the amount of indirect CO₂ emissions generated by the electricity consumption.

> Lowest level refrigerant charge

Toshiba is committed to minimising the refrigerant charge of its products and has made this a key performance indicator for all new product developments.

> European F-GAS regulation

R32 is today the right alternative to R410A. The European F-gas regulation (517/2014) has been in force since 1 January 2015 and will progressively phase down the use of hydrofluorocarbons (HFCs) in the heating and cooling systems of the future. Toshiba already offers new heating and cooling systems operating with R32, which will be the alternative to R410A in the years ahead. The new R32 refrigerant ensures an ideal balance between energy-efficiency and respect for the environment. The quantities of HFCs that are placed on the market will be gradually reduced in a step-by-step approach, until they finally reach a minimum level by 2030.



HFC consumption related to tons of CO₂ equivalent



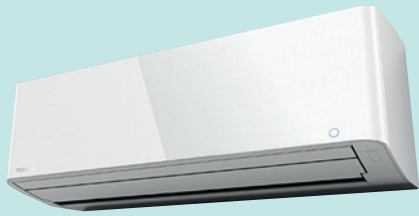

DAISEIKAI 9



HAORI



SHORAI



SEIYA



CONSOLE

R410A
with TOSHIBA



**ADVANCED TECHNOLOGY AVAILABLE
WITH R32 & R410A REFRIGERANTS**

RESIDENTIAL AIR-TO-AIR

Toshiba Home AC Control

Take complete control of your comfort with the Toshiba Home AC Control App. Simple to use on your smartphone or tablet, both at home and on the move. Fully compatible, the adapter can be used with all Toshiba High-wall and Console units.





EUROPE

RAS-B-N4KVRG-E
HAORI



HAORI, the air conditioner that respects your universe with a truly elegant design, featuring a stylish textile fabric cover. Innovation, efficiency, high reliability, energy savings, respect for the environment: these powerful values are at the heart of everything we do at Toshiba. HAORI offers energy efficient A+++ cooling and heating performances, with R32 refrigerant.

Truly elegant design featuring a stylish textile fabric cover.

High energy class A+++ / A+++

- Heating and cooling modes ensure exceptional energy savings and unparalleled comfort levels.

Ultra-quiet system

- HAORI Silent function halves the sound level of the outdoor unit down to 37 dB(A), while its Quiet function reduces noise from the indoor unit to less than 19 dB(A) for a good night's sleep.

Indoor Air Quality

- The new Toshiba Ultra Pure Filter captures up to 94% of PM2.5 (particulate matters coming from atmospheric pollution), creating healthy living spaces at home.
- Toshiba Plasma Ionizer, catches & neutralizes the contaminated particles.
- HAORI is equipped with the Magic Coil® which helps prevent water and dust from sticking to the coil.



MAX EFFICIENCY



SEER 8.7
SCOP 5.1

CAPACITY



2.5kW > 4.6kW

OPERATION



-15°C > +46°C

> **Silent modes** with indoor unit
Quiet mode & Silent outdoor unit function

> **Toshiba HAORI luxury remote control** features a magnetic wall mounted holder

> **Intuitive remote-control functions** with Power select and ECO modes to reduce energy bills, Hi-power for rapid cooling or heating

> **Enhance your comfort at home or away** with Toshiba Home AC app

> **HAORI features** energy monitoring and speaker voice control functions compatible with Google Home Assistant & Amazon Alexa.

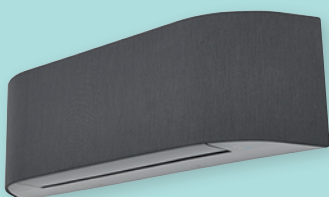

INDOOR UNITS

RAS-B10N4KVRG-E
RAS-B13N4KVRG-E
RAS-B16N4KVRG-E



OUTDOOR UNITS

RAS-10J2AVSG-E1
RAS-13J2AVSG-E1
RAS-16J2AVSG-E1



REMOTE CONTROLS

Delivered with the unit

HAORI Performance data

Outdoor unit			RAS-10J2AVSG-E1	RAS-13J2AVSG-E1	RAS-16J2AVSG-E1
Indoor unit			RAS-B10N4KVRG-E	RAS-B13N4KVRG-E	RAS-B16N4KVRG-E
Cooling capacity	kW		2.5	3.5	4.6
Cooling range (min. - max.)	kW		(0.89 - 3.20)	(1.00 - 4.10)	(1.20 - 5.30)
Power input (min. -rated - max.)	kW	C	(0.19 - 0.54 - 0.79)	(0.25 - 0.80 - 1.12)	(0.34 - 1.35 - 1.72)
Pdesignc	kW		2.5	3.5	4.6
EER	W/W		4.63	4.38	3.41
SEER			8.60	8.70	7.80
Energy efficiency class		C	A+++	A+++	A++
Seasonal electricity consumption	kWh/a	C	102	142	206
Heating capacity	kW		3.2	4.2	5.5
Heating range (min. - max.)	kW		(0.90 - 4.70)	(1.00 - 5.30)	(1.10 - 6.30)
Power input (min. -rated - max.)	kW	H	(0.18 - 0.74 - 1.23)	(0.20 - 1.08 - 1.55)	(0.30 - 1.52 - 1.90)
Pdesignh	kW		2.5	3.2	4.00
COP	W/W		4.32	3.89	3.62
SCOP			5.10	5.10	4.60
Energy efficiency class		H	A+++	A+++	A++
Seasonal electricity consumption	kWh/a	H	684	876	1214

HAORI Physical data indoor

Indoor unit			RAS-B10N4KVRG-E	RAS-B13N4KVRG-E	RAS-B16N4KVRG-E
Air flow (h)	m ³ /h - l/s	C	600 - 166	670 - 186	690 - 180
Air flow (l)	m ³ /h - l/s	C	300 - 83	320 - 89	340 - 83
Sound pressure level (h/q)	dB(A)	C	41/19	43/19	45/21
Sound power level (h)	dB(A)	C	54	56	58
Air flow (h)	m ³ /h - l/s	H	610 - 169	680 - 189	730 - 186
Air flow (l)	m ³ /h - l/s	H	300 - 86	320 - 89	360 - 83
Sound pressure level (h/q)	dB(A)	H	41/19	43/19	45/22
Sound power level (h)	dB(A)	H	54	56	58
Dimensions (hxwx d)	mm		300 x 987 x 210	300 x 987 x 210	300 x 987 x 210
Weight	kg		11	11	12
Remote controller			WH-UA01UE	WH-UA01UE	WH-UA01UE

HAORI Physical data outdoor

Outdoor unit			RAS-10J2AVSG-E1	RAS-13J2AVSG-E1	RAS-16J2AVSG-E1
Air flow (max)	m ³ /h - l/s	C	1890 - 524	1950 - 540	2040 - 566
Sound pressure level (h)	dB(A)	C	44	46	48
Sound pressure level (Silent CDU#2)	dB(A)	C	37	39	40
Sound power level (h)	dB(A)	C	57	59	61
Sound power level ((Silent CDU#2)	dB(A)	C	50	52	53
Operating range	°C	C	-15 - 46	-15 - 46	-15 - 46
Air flow (max)	m ³ /h - l/s	H	1890 - 524	1950 - 540	2040 - 566
Sound pressure level (h)	dB(A)	H	46	48	50
Sound pressure level (Silent CDU#2)	dB(A)	H	39	43	43
Sound power level (h)	dB(A)	H	59	61	63
Sound power level ((Silent CDU#2)	dB(A)	H	52	56	56
Operating range	°C	H	-15 - 24	-15 - 24	-15 - 24
Dimensions (hxwx d)	mm		550 x 780 x 290	550 x 780 x 290	550 x 780 x 290
Weight	kg		26	30	33
Compressor type			DC Rotary	DC Rotary	DC Rotary
Flare connections (gas-liquid)			3/8" - 1/4"	3/8" - 1/4"	1/2" - 1/4"
Minimum pipe length	m		2	2	2
Maximum pipe length	m		20	20	20
Maximum height difference	m		12	12	12
Chargeless pipe length	m		15	15	15
Refrigerant charging (R32)	kg		0.55	0.8	0.8
Power supply	V-ph-Hz		230-1-50	230-1-50	230-1-50

C: cooling mode
H: heating mode

RAS- PKVPG-E
DAISEIKAI 9



The exclusive New Daiseikai 9 is the market benchmark for high efficiency solution. Its new elegant design and higher standards in efficiency and comfort, maximize energy savings, and offer exceptional indoor air quality thanks to its exclusive filtration system.

High Energy Class A+++ / A+++

- Very high energy efficiency class, both in cooling and heating.
- Very low energy consumption in all conditions.
- Wide operating range.

Extremely silent

- Less than 20dB(A) in silent mode.

Indoor air quality with double filtration system

- The Plasma Ion Charger filtration system associated with self-cleaning coil provides a pure and healthy environment.
- The Ionizer System provides pure air by absorbing smoke and bad odors, this function can be activated anytime by pushing the "PURE" button on remote controller.

User friendly wireless remote control with weekly timer

- One-Touch User Comfort parameter pre-set.
- 8°C button for anti-frost during holiday periods.
- Comfort Sleep for extra silence mode.
- 3D airflow control with vertical & horizontal motorized louvers: pre-set directions or automatic sweeping.
- Weekly timer with 4 freely programmable settings per day and 7 different programs per week.
- Capacity booster to reach comfort set point very fast.
- Outdoor unit noise reduction at night.
- Fire place mode with constant fan speed to improve comfort in all conditions.



MAX EFFICIENCY



SEER 10.5
SCOP 5.20

CAPACITY



2.5kW > 4.5kW

OPERATION



-15°C > +46°C

> **Elegant & modern design** with discreet dimming lights changing colors with cooling and heating modes

> **100% Toshiba quality with DC Twin- Rotary inverter compressor**

> **Wifi control ready** with Wifi module accessory integrated in large High wall chassis

> **Exceptional indoor air quality** Impurities are ionized by the plasma ion charger and absorbed by heat exchanger



INDOOR UNITS

RAS- 10PKVPG-E
RAS- 13PKVPG-E
RAS- 16PKVPG-E



OUTDOOR UNITS

RAS- 10PAVPG-E
RAS- 13PAVPG-E
RAS- 16PAVPG-E



REMOTE CONTROLS

Delivered with the unit

DAISEIKAI 9 Performance data

Outdoor unit	Europe		RAS-10PAVPG-E	RAS-13PAVPG-E	RAS-16PAVPG-E
Indoor unit			RAS-10PKVPG-E	RAS-13PKVPG-E	RAS-16PKVPG-E
Cooling capacity	kW		2,5	3,5	4,5
Cooling range (min. - max.)	kW		(0.80 - 3.50)	(0.90 - 4.10)	(0.90 - 5.10)
Power input (min. -rated - max.)	kW	C	(0.15 - 0.45 - 0.82)	(0.18 - 0.75 - 1.00)	(0.18 - 1.08 - 1.38)
Pdesignc	kW		2.5	3.5	4.5
EER	W/W		5.56	4.67	4.17
SEER			10.6	9.5	8.50
Energy efficiency class		C	A+++	A+++	A+++
Seasonal electricity consumption	kWh/a	C	83	129	185
Heating capacity	kW		3.2	4.0	4.5
Heating range (min. - max.)	kW		(0.70 - 5.80)	(0.80 - 6.30)	(0.80 - 6.80)
Power input (min. -rated - max.)	kW	H	(0.15 - 0.60 - 1.55)	(0.17 - 0.80 - 2.00)	(0.17 - 1.37 - 2.05)
Pdesignh (Tbiv-10°C)	kW		3.0	3.6	4.5
COP	W/W		5.33	5.0	4.01
SCOP			5.2	5.1	4.6
Energy efficiency class		H	A+++	A+++	A++
Seasonal electricity consumption	kWh/a	H	807	988	1369

DAISEIKAI 9 Physical data indoor

Indoor unit	Europe		RAS-10PAVPG-E	RAS-13PAVPG-E	RAS-16PAVPG-E
Air Flow (h)	m³/h - l/s	C	690 - 188	710 - 197	730 - 203
Air Flow (l)	m³/h - l/s	C	300 - 83	300 - 83	310 - 86
Sound pressure level (h/q)	dB(A)	C	43/20	44/20	45/22
Sound power level (h)	dB(A)	C	58	59	60
Air Flow (h)	m³/h - l/s	H	720 - 200	720 - 200	740 - 206
Air Flow (l)	m³/h - l/s	H	310 - 83	310 - 86	330 - 91
Sound pressure level (h/q)	dB(A)	H	44/20	45/20	46/22
Sound power level (h)	dB(A)	H	59	60	61
Dimensions (hxwx d)	mm		293 x 851 x 270	293 x 851 x 270	293 x 851 x 270
Weight	kg		14	14	14

DAISEIKAI 9 Physical data outdoor

Outdoor unit	Europe		RAS-10PKVPG-E	RAS-13PKVPG-E	RAS-16PKVPG-E
Air Flow (max)	m³/h - l/s	C	2160 - 600	2160 - 600	2160 - 600
Sound pressure level (h)	dB(A)	C	46	48	49
Sound pressure level (Silent CDU#2)	dB(A)	C	43	43	44
Sound power level (h)	dB(A)	C	61	63	64
Sound power level (Silent CDU#2)	dB(A)	C	58	58	59
Operating range	°C	C	-15 ~ 46	-15 ~ 46	-15 ~ 46
Air Flow (max)	m³/h - l/s	H	2160 - 600	2160 - 600	2160 - 600
Sound pressure level (h)	dB(A)	H	47	50	50
Sound pressure level (Silent CDU#2)	dB(A)	H	42	45	45
Sound power level (h)	dB(A)	H	62	65	65
Sound power level (Silent CDU#2)	dB(A)	H	57	60	60
Operating range	°C	H	-15 ~ 24	-15 ~ 24	-15 ~ 24
Dimensions (hxwx d)	mm		630 x 800 x 300	630 x 800 x 300	630 x 800 x 300
Weight	kg		38	38	38
Compressor type			DC Twin Rotary	DC Twin Rotary	DC Twin Rotary
Flare connections (gas-liquid)			3/8" - 1/4"	3/8" - 1/4"	1/2" - 1/4"
Minimum pipe length	m		2	2	2
Maximum pipe length	m		25	25	25
Maximum height difference	m		10	10	10
Chargeless pipe length	m		15	15	15
Remote controller			WH-TA01LE	WH-TA01LE	WH-TA01LE
Refrigerant charging(R32)	kg		1,0	1,0	1,0
Power supply	V-ph-Hz		220-240/1/50	220-240/1/50	220-240/1/50

C: cooling mode
H: heating mode

RAS-J2KVRG-E
SHORAI PREMIUM

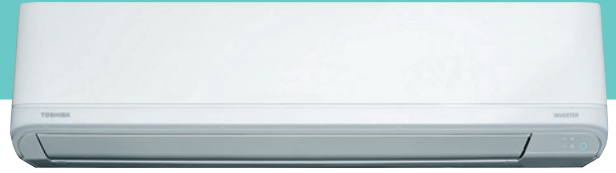

The SHORAI Premium combines elegant design and technology for higher standards in efficiency, comfort and energy savings. Benefit from exceptional indoor air quality thanks to the exclusive ionizer filtration system. SHORAI Premium high-walls are compatible with Monosplit & Multisplit outdoor units (B-code).

High energy class A++ / A++

- Very high energy efficiency class, both in heating and cooling.
- Very low energy consumption in all conditions.

Indoor air quality with the Ionizer Filter

- The Ionizer filtration system provides pure air by absorbing smoke and bad odors. This function can be activated anytime by pushing the "PURE" button on the remote controller.
- Associated with Toshiba self-cleaning coil, SHORAI Premium provides a pure and healthy environment.

User friendly wireless remote control with weekly timer

- One-Touch User Comfort parameter pre-set.
- 8°C button for anti-frost during holiday periods.
- Comfort Sleep for extra silence mode.
- 3D airflow control with vertical & horizontal motorized louvers: pre-set directions or automatic sweeping (large chassis only).
- Weekly timer with 4 freely programmable settings per day and 7 different programs per week.
- Capacity booster to reach comfort set point very fast.
- Outdoor unit noise reduction at night.
- Fire place mode with constant fan speed to improve comfort in all conditions.

MAX EFFICIENCY



SEER 7.3
SCOP 4.6

CAPACITY



2.5kW > 7.0kW

OPERATION



-15°C > +46°C

> **Elegant & modern design** with discreet dimming lights changing colors with cooling and heating modes

> **100% Toshiba quality with DC twin-rotary inverter compressor (large chassis)**

> **Wi-Fi control ready** with **Toshiba Home AC Control** adaptor integrated in large high-wall chassis

> **Exceptional indoor air quality** Impurities are ionized by the filter and absorbed by the heat exchanger



INDOOR UNITS

- RAS-B10J2KVRG-E
- RAS-B13J2KVRG-E
- RAS-B16J2KVRG-E
- RAS-18J2KVRG-E
- RAS-B22J2KVRG-E
- RAS-B24J2KVRG-E



OUTDOOR UNITS

- RAS-10J2AVRG-E
- RAS-13J2AVRG-E
- RAS-16J2AVRG-E
- RAS-18J2AVRG-E
- RAS-22J2AVRG-E
- RAS-24J2AVRG-E



REMOTE CONTROLS

Delivered with the unit

SHORAI PREMIUM

SHORAI PREMIUM R32 Performance data

Outdoor unit			RAS-10J2AVRG-E	RAS-13J2AVRG-E	RAS-16J2AVRG-E	RAS-18J2AVRG-E	RAS-22J2AVRG-E	RAS-24J2AVRG-E
Indoor unit			RAS-B10J2KVRG-E	RAS-B13J2KVRG-E	RAS-B16J2KVRG-E	RAS-18J2KVRG-E	RAS-B22J2KVRG-E	RAS-B24J2KVRG-E
Cooling capacity	kW		2.5	3.5	4.6	5.0	6.1	7.0
Cooling range (min. - max.)	kW		0.75 - 3.2	0.8 - 4.1	1.2 - 5.3	1.24 - 6.0	1.29 - 6.7	1.5 - 7.7
Power input (min.-rated - max.)	kW	C	(0.17 - 0.6 - 0.82)	(0.18 - 1.05 - 1.25)	(0.23 - 1.4 - 1.72)	(0.23 - 1.42 - 2.00)	(0.24 - 1.99 - 2.20)	(0.30 - 2.25 - 2.55)
Pdesignc	kW		2.5	3.5	4.6	5.0	6.1	7.0
EER	W/W		4.17	3.33	3.29	3.52	3.07	3.11
SEER			6.9	6.5	6.5	7.3	6.8	6.25
Energy efficiency class		C	A++	A++	A++	A++	A++	A++
Seasonal electricity consumption	kWh/a	C	127	189	248	240	314	392
Heating capacity	kW		3.2	4.2	5.5	6.0	7.0	8.0
Heating range (min. - max.)	kW		0.9 - 4.8	0.8 - 5.3	0.9 - 6.5	0.88 - 6.5	0.93 - 7.5	1.6 - 8.8
Power input (min.-rated - max.)	kW	H	(0.17 - 0.75 - 1.40)	(0.15 - 1.08 - 1.55)	(0.17 - 1.52 - 1.82)	(0.16 - 1.60 - 1.75)	(0.19 - 1.94 - 2.10)	(0.30 - 2.41 - 2.75)
Pdesignh	kW		2.5	3.2	4.0	4.3	4.7	6.3
COP	W/W		4.27	3.89	3.62	3.75	3.61	3.32
SCOP			4.6	4.6	4.2	4.4	4.4	4.07
Energy efficiency class		H	A++	A++	A+	A+	A+	A+
Seasonal electricity consumption	kWh/a	H	761	974	1335	1368	1495	2166

SHORAI PREMIUM Physical data indoor

Indoor unit			RAS-B10J2KVRG-E	RAS-B13J2KVRG-E	RAS-B16J2KVRG-E	RAS-18J2KVRG-E	RAS-B22J2KVRG-E	RAS-B24J2KVRG-E
Air Flow (h)	m³/h - l/s	C	564 - 156	624 - 173	750 - 208	950 - 264	984 - 273	1074 - 298
Air Flow (l)	m³/h - l/s	C	240 - 67	300 - 83	330 - 92	535 - 149	622 - 173	664 - 184
Sound pressure level (h/a)	dB(A)	C	38/22	39/22	43/24	44/26	45/27	47/28
Sound power level (h)	dB(A)	C	53	54	58	59	60	62
Air Flow (h)	m³/h - l/s	H	600 - 167	636 - 176	768 - 213	950 - 264	984 - 273	1128 - 313
Air Flow (l)	m³/h - l/s	H	252 - 70	320 - 89	348 - 97	499 - 139	606 - 168	738 - 205
Sound pressure level (h/a)	dB(A)	H	39/23	39/23	43/25	44/26	46/27	48/28
Sound power level (h)	dB(A)	H	54	54	58	59	61	63
Dimensions (hxwxwd)	mm		293 x 798 x 241	293 x 798 x 241	293 x 798 x 241	320 x 1050 x 265	320 x 1050 x 265	320 x 1050 x 265
Weight	kg		9	9	9	15	15	15
Remote controller			WH-TB03LE	WH-TB03LE	WH-TB03LE	WH-TB01LE	WH-TB01LE	WH-TB01LE

SHORAI PREMIUM Physical data outdoor

Outdoor unit			RAS-10J2AVRG-E	RAS-13J2AVRG-E	RAS-16J2AVRG-E	RAS-18J2AVRG-E	RAS-22J2AVRG-E	RAS-24J2AVRG-E
Air Flow (max)	m³/h - l/s	C	1668 - 463	1980 - 550	2040 - 566	2076 - 576	2184 - 607	2916 - 810
Sound pressure level (h)	dB(A)	C	46	48	49	49	53	53
Sound power level (h)	dB(A)	C	61	63	64	64	68	68
Operating range	°C	C	-15 ~ 46	-15 ~ 46	-15 ~ 46	-15 ~ 46	-15 ~ 46	-15 ~ 46
Air Flow (max)	m³/h - l/s	H	1668 - 463	1980 - 550	2160 - 600	1914 - 532	2184 - 607	2916 - 810
Sound pressure level (h)	dB(A)	H	47	50	52	50	52	53
Sound power level (h)	dB(A)	H	62	65	67	65	67	68
Operating range	°C	H	-15 ~ 24	-15 ~ 24	-15 ~ 24	-15 ~ 24	-15 ~ 24	-15 ~ 24
Dimensions (hxwxwd)	mm		550 x 780 x 290	550 x 780 x 290	550 x 780 x 290	550 x 780 x 290	550 x 780 x 290	630 x 800 x 300
Weight	kg		28	34	34	34	34	43
Compressor type			DC Rotary	DC Rotary	DC Rotary	DC Twin Rotary	DC Twin Rotary	DC Twin Rotary
Flare connections (gas-liquid)			3/8" - 1/4"	3/8" - 1/4"	1/2" - 1/4"	1/2" - 1/4"	1/2" - 1/4"	1/2" - 1/4"
Minimum pipe length	m		2	2	2	2	2	2
Maximum pipe length	m		20	20	20	20	20	25
Maximum height difference	m		12	12	12	12	12	15
Chargeless pipe length	m		15	15	15	15	15	15
Refrigerant charging(R32)	kg		0.51	0.67	0.8	1.1	1.1	1.14
Power supply	V-ph-Hz		230-1-50	230-1-50	230-1-50	230-1-50	230-1-50	230-1-50

C: cooling mode
H: heating mode

RAS-J2KVSG-E
SHORAI EDGE

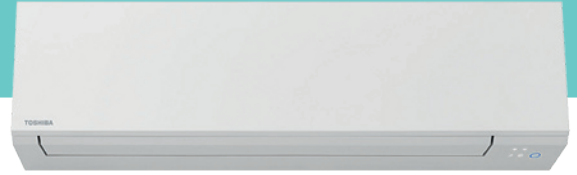

SHORAI Edge, a fresh take on design and performance, benefits from Toshiba's latest innovative inverter and compressor technology. It is designed to deliver high performance, making everyday comfort a reality for all. SHORAI Edge offers energy efficient A+++ cooling and heating performances, with R32 refrigerant. Compatible with Monosplit & Multisplit outdoor units (B-codes).

High energy class A+++ / A+++

- Heating and cooling modes ensure exceptional energy savings and unparalleled comfort levels.

Absolute silent operation

- SHORAI Edge's Silent function halves the sound level of the outdoor unit, while its Quiet function reduces noise from the indoor unit for a good night's sleep.

Indoor Air Quality

- The new Toshiba Ultra Pure Filter captures up to 94% of PM2.5 (particulate matters coming from atmospheric pollution), creating healthy living spaces at home.
- SHORAI Edge is equipped with the Magic Coil® which helps prevent water and dust from sticking to the coil. When the air conditioning is switched off to drain the contaminated coil, the fan continues to operate to keep the coil clean and dry whilst preserving the air conditioning high energy efficiency.

User friendly wireless remote control with weekly timer

- HADA-CARE to set louver position to generate indirect air flow for better air distribution to homogenize room temperature.
- Quiet mode for Comfort Sleep operating indoor at the lowest noise level
- Silent CDU is Toshiba's unique noise reduction function of outdoor unit for neighborhood comfort.
- Hi Power capacity booster to reach comfort set point very fast.
- OFF timer provides a very convenient automatic programmable stop function.
- On-demand Defrost for manual defrost at any time in extreme conditions.

MAX EFFICIENCY



SEER 8.6
SCOP 5.1

CAPACITY



2.0kW > 8.0kW

OPERATION



-15°C > +46°C

> **Modern edge design** with discreet dimming lights

> **100% Toshiba quality with DC rotary inverter compressor**

> **Wi-Fi control ready** with **Toshiba Home AC Control** adaptor inside FCU

> **Silent modes** with indoor unit Quiet mode & Silent outdoor unit function



INDOOR UNITS

- RAS-B07J2KVSG-E
- RAS-B10J2KVSG-E
- RAS-B13J2KVSG-E
- RAS-B16J2KVSG-E
- RAS-18J2KVSG-E
- RAS-B22J2KVSG-E
- RAS-B24J2KVSG-E



OUTDOOR UNITS

- RAS-07J2AVSG-E
- RAS-10J2AVSG-E1
- RAS-13J2AVSG-E1
- RAS-16J2AVSG-E1
- RAS-18J2AVSG-E
- RAS-22J2AVSG-E
- RAS-24J2AVSG-E



REMOTE CONTROLS

Delivered with the unit

SHORAI EDGE R32 Performance data

Outdoor unit		RAS-07J2AVSG-E RAS-10J2AVSG-E1 RAS-13J2AVSG-E1 RAS-16J2AVSG-E1 RAS-18J2AVSG-E RAS-22J2AVSG-E RAS-24J2AVSG-E						
Indoor unit		RAS-B07J2KVSG-E RAS-B10J2KVSG-E RAS-B13J2KVSG-E RAS-B16J2KVSG-E RAS-18J2KVSG-E RAS-B22J2KVSG-E RAS-B24J2KVSG-E						
Cooling capacity	kW	2,0	2,5	3,5	4,6	5,0	6,1	7,0
Cooling range (min. - max.)	kW	(0.89 - 2.90)	(0.89 - 3.20)	(1.00 - 4.10)	(1.20 - 5.30)	(1.20 - 6.00)	(1.39 - 6.70)	(1.70 - 7.70)
Power input (min.-rated - max.)	kW C	(0.19 - 0.39 - 0.67)	(0.19 - 0.54 - 0.79)	(0.25 - 0.90 - 1.12)	(0.34 - 1.35 - 1.72)	(0.35 - 1.42 - 2.00)	(0.36 - 1.99 - 2.20)	(0.38 - 2.25 - 2.55)
Pdesignc	kW	2.0	2.5	3.5	4.6	5.0	6.1	7.0
EER	W/W	5.13	4.63	3.89	3.41	3.52	3.07	3.11
SEER		8.5	8.6	8.6	7.8	7.8	7.3	6.3
Energy efficiency class	C	A+++	A+++	A+++	A++	A++	A++	A++
Seasonal electricity consumption kWh/a	C	82	102	142	206	224	292	389
Heating capacity	kW	2.5	3.2	4.2	5.5	6.0	7.0	8.0
Heating range (min. - max.)	kW	(0.90 - 3.60)	(0.90 - 4.80)	(1.00 - 5.30)	(1.10 - 6.50)	(1.10 - 6.50)	(1.15 - 7.50)	(1.70 - 8.80)
Power input (min.-rated - max.)	kW H	(0.16 - 0.50 - 0.80)	(0.16 - 0.70 - 1.23)	(0.20 - 1.08 - 1.55)	(0.24 - 1.52 - 1.90)	(0.25 - 1.59 - 1.75)	(0.26 - 1.88 - 2.10)	(0.29 - 2.35 - 2.75)
Pdesignh	kW	2.3	2.5	3.2	4.00	4.3	4.7	6.3
COP	W/W	5.00	4.57	3.89	3.62	3.77	3.72	3.40
SCOP		5.1	5.1	5.1	4.6	4.6	4.6	4.1
Energy efficiency class	H	A+++	A+++	A+++	A++	A++	A++	A+
Seasonal electricity consumption kWh/a	H	631	686	878	1217	1309	1430	2149

SHORAI EDGE R32 Physical data indoor

Indoor unit		RAS-B07J2KVSG-E RAS-B10J2KVSG-E RAS-B13J2KVSG-E RAS-B16J2KVSG-E RAS-18J2KVSG-E RAS-B22J2KVSG-E RAS-B24J2KVSG-E						
Air Flow (h)	m³/h - l/s C	660 - 183	660 - 183	732 - 203	750 - 208	990 - 274	1032 - 286	1122 - 311
Air Flow (l)	m³/h - l/s C	312 - 86	312 - 86	342 - 95	360 - 100	570 - 158	690 - 191	720 - 199
Sound pressure level (h/q)	dB(A) C	40/19	40/19	43/19	44/21	44/26	45/27	47/28
Sound power level (h)	dB(A) C	53	53	56	57	57	58	60
Air Flow (h)	m³/h - l/s H	660 - 183	660 - 183	732 - 203	768 - 213	990 - 274	1080 - 299	1140 - 316
Air Flow (l)	m³/h - l/s H	312 - 86	312 - 86	342 - 95	360 - 100	570 - 158	690 - 191	750 - 208
Sound pressure level (h/q)	dB(A) H	40/19	40/19	43/19	44/22	44/26	46/27	48/28
Sound power level (h)	dB(A) H	53	53	56	57	57	59	61
Dimensions (hwxwd)	mm	293 x 800 x 226	293 x 800 x 226	293 x 800 x 226	293 x 800 x 226	320 x 1053 x 245	320 x 1053 x 245	320 x 1053 x 245
Weight	kg	10	10	10	10	14	14	14
Remote controller		WH-TA15PE	WH-TA15PE	WH-TA15PE	WH-TA15PE	WH-TA12PE	WH-TA12PE	WH-TA12PE

SHORAI EDGE R32 Physical data outdoor

Outdoor unit		RAS-07J2AVSG-E RAS-10J2AVSG-E1 RAS-13J2AVSG-E1 RAS-16J2AVSG-E1 RAS-18J2AVSG-E RAS-22J2AVSG-E RAS-24J2AVSG-E						
Air Flow (max)	m³/h - l/s C	1890 - 524	1890 - 524	1950 - 540	2040 - 566	2076 - 576	2184 - 607	2916 - 810
Sound pressure level (h)	dB(A) C	44	44	46	48	48	49	50
Sound pressure level (Silent CDU#2)	dB(A) C	36	37	39	40	42	43	43
Sound power level (h)	dB(A) C	57	57	59	61	61	62	63
Sound power level (Silent CDU#2)	dB(A) C	49	50	52	53	55	56	56
Operating range	°C C	-15 ~ 46	-15 ~ 46	-15 ~ 46	-15 ~ 46	-15 ~ 46	-15 ~ 46	-15 ~ 46
Air Flow (max)	m³/h - l/s H	1890 - 524	1890 - 524	1950 - 540	2040 - 566	2076 - 576	2184 - 607	2916 - 810
Sound pressure level (h)	dB(A) H	46	46	48	50	50	51	52
Sound pressure level (Silent CDU#2)	dB(A) H	38	39	43	43	44	46	46
Sound power level (h)	dB(A) H	59	59	61	63	63	64	65
Sound power level (Silent CDU#2)	dB(A) H	51	52	56	56	57	59	59
Operating range	°C H	-15 ~ 24	-15 ~ 24	-15 ~ 24	-15 ~ 24	-15 ~ 24	-15 ~ 24	-15 ~ 24
Dimensions (hwxwd)	mm	550 x 780 x 290	550 x 780 x 290	550 x 780 x 290	550 x 780 x 290	550 x 780 x 290	550 x 780 x 290	630 x 800 x 300
Weight	kg	26	26	30	33	34	34	42
Compressor type		DC Rotary	DC Rotary	DC Rotary	DC Rotary	DC Twin Rotary	DC Twin Rotary	DC Twin Rotary
Flare connections (gas-liquid)		3/8" - 1/4"	3/8" - 1/4"	3/8" - 1/4"	1/2" - 1/4"	1/2" - 1/4"	1/2" - 1/4"	1/2" - 1/4"
Minimum pipe length	m	2	2	2	2	2	2	2
Maximum pipe length	m	20	20	20	20	20	20	25
Maximum height difference	m	12	12	12	12	12	12	15
Chargeless pipe length	m	15	15	15	15	15	15	15
Refrigerant charging(R32)	kg	0.55	0.55	0.8	0.8	1.1	1.1	1.14
Power supply	V-ph-Hz	230-1-50	230-1-50	230-1-50	230-1-50	230-1-50	230-1-50	230-1-50

C: cooling mode
H: heating mode

RESIDENTIAL AIR-TO-AIR

RAS-J2KVG-E
SEIYA

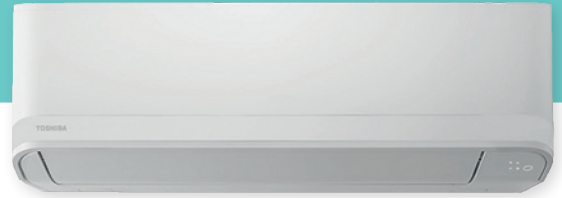

SEIYA, "Silent night" in Japanese, benefits from Toshiba's latest innovative inverter and compressor technology. It is designed to deliver high performance, making everyday comfort a reality for all. SEIYA offers energy efficient A++ cooling and A+ heating performances, with R32 refrigerant. Compatible with Monosplit & Multisplit outdoor units (B-codes).

High energy class A++ / A+

- Heating and cooling modes ensure exceptional energy savings and unparalleled comfort levels.

Extremely silent operation

- SEIYA 's Silent function halves the sound level of the outdoor unit, while its Quiet function reduces noise from the indoor unit for a good night's sleep.

Indoor Air Quality

- SEIYA is equipped with the Magic Coil® which helps prevent water and dust from sticking to the coil. When the air conditioning is switched off to drain the contaminated coil, the fan continues to operate to keep the coil clean and dry whilst preserving the air conditioning high energy efficiency.

User friendly wireless remote control with weekly timer

- Quiet mode for Comfort Sleep operating indoor at the lowest noise level
- Silent CDU is Toshiba's unique noise reduction function of outdoor unit for neighborhood comfort.
- Hi Power capacity booster to reach comfort set point very fast.
- OFF timer provides a very convenient automatic programmable stop function.
- On-demand Defrost for manual defrost at any time in extreme conditions.

MAX EFFICIENCY



SEER 6.1
SCOP 4.0

CAPACITY



1.5kW > 6.5kW

OPERATION



-15°C > +46°C

- > **Elegant & modern design** with discreet dimming lights
- > **100% Toshiba quality with DC rotary inverter compressor**
- > **Wi-Fi control ready with Toshiba Home AC Control** adaptor
- > **Silent modes** with indoor unit Quiet mode & Silent outdoor unit function



INDOOR UNITS

- RAS-B05J2KVG-E
- RAS-B07J2KVG-E
- RAS-B10J2KVG-E
- RAS-B13J2KVG-E
- RAS-B16J2KVG-E
- RAS-18J2KVG-E
- RAS-24J2KVG-E



OUTDOOR UNITS

- RAS-05J2AVG-E
- RAS-07J2AVG-E
- RAS-10J2AVG-E
- RAS-13J2AVG-E
- RAS-16J2AVG-E
- RAS-18J2AVG-E
- RAS-24J2AVG-E



REMOTE CONTROLS

Delivered with the unit



OPTIONAL RC

RB-RXS30-E
Optional weekly timer
Remote control

SEIYA-R32 Performance data

Outdoor unit	Europe	RAS-05J2AVG-E	RAS-07J2AVG-E	RAS-10J2AVG-E	RAS-13J2AVG-E	RAS-16J2AVG-E	RAS-18J2AVG-E	RAS-24J2AVG-E
Indoor unit		RAS-B05J2KVG-E	RAS-B07J2KVG-E	RAS-B10J2KVG-E	RAS-B13J2KVG-E	RAS-B16J2KVG-E	RAS-18J2KVG-E	RAS-24J2KVG-E
Cooling capacity	kW	1,5	2,0	2,5	3,3	4,2	5,0	6,5
Cooling range (min. - max.)	kW	(0.75 - 2.00)	(0.76 - 2.60)	(0.80 - 3.00)	(1.00 - 3.60)	(1.20 - 4.7)	(1.3 - 5.5)	(1.6 - 7.2)
Power input (min.-rated - max.)	kW C	(0.22 - 0.37 - 0.60)	(0.22 - 0.53 - 0.83)	(0.24 - 0.77 - 1.00)	(0.26 - 1.10 - 1.25)	(0.32 - 1.40 - 1.80)	(0.27 - 1.55 - 1.80)	(0.32 - 2.25 - 2.60)
Pdesignc	kW	1,5	2,0	2,5	3,3	4,2	5,0	6,5
EER	W/W	4.05	3.77	3.25	3.00	3.00	3.23	2.89
SEER		6.1	6.1	6.1	6.1	6.1	6.3	6.1
Energy efficiency class	C	A++	A++	A++	A++	A++	A++	A++
Seasonal electricity consumption	kWh/a C	86	115	143	189	241	278	373
Heating capacity	kW	2,0	2,5	3,2	3,6	5,0	5,4	7,0
Heating range (min. - max.)	kW	(0.90 - 3.00)	(0.92 - 3.30)	(1.00 - 3.90)	(1.10 - 4.50)	(1.30 - 6.00)	(1.0 - 6.0)	(1.6 - 8.1)
Power input (min.-rated - max.)	kW H	(0.19 - 0.47 - 0.73)	(0.19 - 0.64 - 0.90)	(0.20 - 0.86 - 1.11)	(0.22 - 0.92 - 1.24)	(0.24 - 1.40 - 1.70)	(0.20 - 1.60 - 1.85)	(0.29 - 2.10 - 2.55)
Pdesignh (Tbiv-7°C)	kW	1.6	2.0	2.4	2.8	3.6	3.8	5.4
COP	W/W	4.26	3.91	3.72	3.91	3.57	3.38	3.33
SCOP		4.0	4.0	4.0	4.0	4.0	4.0	4.0
Energy efficiency class	H	A+	A+	A+	A+	A+	A+	A+
Seasonal electricity consumption	kWh/a H	560	699	839	980	1259	1329	1890

SEIYA-R32 Physical data indoor

Indoor unit	Europe	RAS-B05J2KVG-E	RAS-B07J2KVG-E	RAS-B10J2KVG-E	RAS-B13J2KVG-E	RAS-B16J2KVG-E	RAS-18J2KVG-E	RAS-24J2KVG-E
Air Flow (h)	m³/h - l/s C	510 - 142	522 - 145	540 - 150	600 - 167	750 - 208	798 - 222	1074 - 298
Air Flow (l)	m³/h - l/s C	234 - 65	234 - 65	240 - 67	264 - 73	330 - 92	480 - 133	666 - 185
Sound pressure level (h/a)	dB(A) C	37/19	38/20	39/21	41/21	43/22	47/27	48/31
Sound power level (h)	dB(A) C	52	53	54	56	58	60	63
Air Flow (h)	m³/h - l/s H	522 - 145	534 - 148	552 - 153	618 - 172	768 - 213	840 - 233	900 - 250
Air Flow (l)	m³/h - l/s H	246 - 68	246 - 68	252 - 70	294 - 82	348 - 97	500 - 139	738 - 205
Sound pressure level (h/a)	dB(A) H	37/19	38/20	39/21	42/21	43/22	48/27	43/31
Sound power level (h)	dB(A) H	52	53	54	57	58	63	58
Dimensions (hxwxwd)	mm	293 x 798 x 230	293 x 798 x 230	293 x 798 x 230	293 x 798 x 230	293 x 798 x 230	293 x 798 x 230	320 x 1050 x 250
Weight	kg	9	9	9	9	10	9	14

SEIYA-R32 Physical data outdoor

Outdoor unit	Europe	RAS-05J2AVG-E	RAS-07J2AVG-E	RAS-10J2AVG-E	RAS-13J2AVG-E	RAS-16J2AVG-E	RAS-18J2AVG-E	RAS-24J2AVG-E
Air Flow (max)	m³/h - l/s C	1800 - 500	1800 - 500	1800 - 500	1980 - 550	2160 - 600	2160 - 600	2220 - 617
Sound pressure level (h)	dB(A) C	46	46	48	48	49	50	55
Sound pressure level (Silent CDU#2)	dB(A) C	42	43	45	46	46	47	51
Sound power level (h)	dB(A) C	61	61	63	63	64	65	70
Sound power level (Silent CDU#2)	dB(A) C	57	58	60	61	61	62	66
Operating range	°C C	-15 ~ 46	-15 ~ 46	-15 ~ 46	-15 ~ 46	-15 ~ 46	-15 ~ 46	-15 ~ 46
Air Flow (max)	m³/h - l/s H	1800 - 500	1800 - 500	1800 - 500	1980 - 550	2160 - 600	2160 - 600	2220 - 617
Sound pressure level (h)	dB(A) H	48	48	50	50	51	52	55
Sound pressure level (Silent CDU#2)	dB(A) H	43	44	46	46	46	48	51
Sound power level (h)	dB(A) H	63	63	65	65	66	67	70
Sound power level (Silent CDU#2)	dB(A) H	58	59	61	61	61	63	66
Operating range	°C H	-15 ~ 24	-15 ~ 24	-15 ~ 24	-15 ~ 24	-15 ~ 24	-15 ~ 24	-15 ~ 24
Dimensions (hxwxwd)	mm	530 x 660 x 240	530 x 660 x 240	530 x 660 x 240	530 x 660 x 240	550x780x290	550x780x290	550x780x290
Weight	kg	22	22	23	24	30	34	38
Compressor type		DC Rotary	DC Rotary	DC Rotary	DC Rotary	DC Rotary	DC Rotary	DC Twin Rotary
Flare connections (gas-liquid)		3/8" - 1/4"	3/8" - 1/4"	3/8" - 1/4"	3/8" - 1/4"	1/2" - 1/4"	1/2" - 1/4"	1/2" - 1/4"
Minimum pipe length	m	2	2	2	2	2	2	2
Maximum pipe length	m	15	15	15	15	20	20	20
Maximum height difference	m	12	12	12	12	12	12	12
Chargeless pipe length	m	15	15	15	15	15	15	15
Remote controller		WH-UC01NE	WH-UC01NE	WH-UC01NE	WH-UC01NE	WH-UC01NE	WH-UC01NE	WH-UC01NE
Refrigerant charging(R32)	kg	0.4	0.4	0.43	0.46	0.62	0.88	1.08
Power supply	V-ph-Hz	220-240/1/50	220-240/1/50	220-240/1/50	220-240/1/50	220-240/1/50	220-240/1/50	220-240/1/50

C: cooling mode
H: heating mode

RAS-J2FVG-E
CONSOLE



This innovative and compact unit has been designed to be installed on the floor and in low wall applications, fitting perfectly under the window sills or in a low ceiling attic. The Console is compatible with Monosplit & Multisplit condensing units (B-code). Compact and modern design in all three dimensions (H600 x L700 x D220 cm).

Energy efficiency class A++ / A++

- High energy efficiency class in cooling.
- Low energy consumption in all conditions.

Bi-flow air diffusion system

- This feature enables users to select the favorable air flow outlet between the two available positions at the top and bottom front of the unit.
- The unique floor heating function, allows the unit to deliver a powerful flow at floor level for a uniform and comfortable room heating.

Toshiba Indoor Air Quality filtration system

- Toshiba IAQ's technology is able to seriously inhibit the reproductive ability of harmful elements. Its deodorizing power absorbs and decomposes, smoke, food smells and bad odors.
- Toshiba's new self-cleaning function is designed to reduce the humidity that causes mould to form inside an air-conditioning unit. This advanced, efficient system reduces moisture in the coils for healthier air to breathe.

User friendly wireless remote control with weekly timer

- Child-lock function on the unit display panel.
- Brightness level control of the display unit to reduce the led light glow.
Automatic restart function in case of unexpected electricity supply line power cuts.
- Standard Toshiba functions: Weekly timer 24h, Power select, 8°C.

MAX EFFICIENCY



SEER 7.20
SCOP 4.7

CAPACITY



2.5kW > 5.0kW

OPERATION



-15°C > +46°C

- > B-code for Mono & Multi compatibility
- > 100% Toshiba quality with DC Twin Rotary inverter compressor on large chassis
- > Wifi control compatible
- > Toshiba Indoor Air Quality filters
- > Floor warming
- > Silent CDU mode
- > Fire place mode
- > On demand defrost



INDOOR UNITS

RAS-B10J2FVG-E
RAS-B13J2FVG-E
RAS-B18J2FVG-E



OUTDOOR UNITS

RAS-10J2AVSG-E1
RAS-13J2AVSG-E1
RAS-18J2AVSG-E



REMOTE CONTROLS

WH-TA12LE
delivered with the unit

CONSOLE Performance data

Outdoor unit			RAS-10J2AVSG-E1	RAS-13J2AVSG-E1	RAS-18J2AVSG-E
Indoor unit			RAS-B10J2FVG-E	RAS-B13J2FVG-E	RAS-B18J2FVG-E
Cooling capacity	kW		2,5	3,5	5,0
Cooling range (min. - max.)	kW		0.95 - 3.2	1.05 - 4.1	1.2 - 5.6
Power input (min. -rated - max.)	kW	C	0.21 - 0.59 - 0.90	0.27 - 0.87 - 1.20	0.34 - 1.68 - 2.00
Pdesignc	kW		2.5	3.5	5.0
EER	W/W		4.24	4.02	2.98
SEER			7.2	7.0	6.8
Energy efficiency class		C	A++	A++	A++
Seasonal electricity consumption	kWh/a	C	121	174	257
Heating capacity	kW		3.2	4.2	6.0
Heating range (min. - max.)	kW		0.85 - 4.40	1.0 - 5.0	1.3 - 6.3
Power input (min. -rated - max.)	kW	H	0.18 - 0.82 - 1.25	0.22 - 1.27 - 1.55	0.31 - 2.05 - 2.20
Pdesignh	kW		2.5	3.0	4.0
COP	W/W		3.90	3.31	2.93
SCOP			4.7	4.7	4.6
Energy efficiency class		H	A++	A++	A++
Seasonal electricity consumption	kWh/a	H	744	893	1217

CONSOLE Physical data indoor

Indoor unit			RAS-B10J2FVG-E	RAS-B13J2FVG-E	RAS-B18J2FVG-E
Air Flow (h)	m ³ /h - l/s	C	492 - 136	528 - 146	600 - 166
Air Flow (l)	m ³ /h - l/s	C	258 - 71	270 - 75	366 - 101
Sound pressure level (h/a)	dB(A)	C	39/23	40/24	46/31
Sound power level (h)	dB(A)	C	52	53	59
Air Flow (h)	m ³ /h - l/s	H	492 - 136	552 - 153	660 - 183
Air Flow (l)	m ³ /h - l/s	H	258 - 71	288 - 80	366 - 101
Sound pressure level (h/a)	dB(A)	H	39/23	40/24	47/31
Sound power level (h)	dB(A)	H	52	53	60
Dimensions (h x w x d)	mm		600 x 700 x 220	600 x 700 x 220	600 x 700 x 220
Weight	kg		16	16	16

CONSOLE Physical data outdoor

Outdoor unit			RAS-10J2AVSG-E1	RAS-13J2AVSG-E1	RAS-18J2AVSG-E
Air Flow (max)	m ³ /h - l/s	C	1890 - 524	1950 - 540	2076 - 576
Sound pressure level (h)	dB(A)	C	45	47	49
Sound pressure level (Silent CDU#2)	dB(A)	C	38	40	43
Sound power level (h)	dB(A)	C	58	60	62
Sound power level (Silent CDU#2)	dB(A)	C	51	53	56
Operating range	°C	C	-15 ~ 46	-15 ~ 46	-15 ~ 46
Air Flow (max)	m ³ /h - l/s	H	1890 - 524	1950 - 540	2076 - 576
Sound pressure level (h)	dB(A)	H	47	49	51
Sound pressure level (Silent CDU#2)	dB(A)	H	40	43	45
Sound power level (h)	dB(A)	H	60	62	64
Sound power level (Silent CDU#2)	dB(A)	H	53	57	58
Operating range	°C	H	-15 ~ 24	-15 ~ 24	-15 ~ 24
Dimensions (h x w x d)	mm		550 x 780 x 290	550 x 780 x 290	550 x 780 x 290
Weight	kg		26	30	34
Compressor type			DC Rotary	DC Rotary	DC Twin Rotary
Flare connections (gas-liquid)			3/8" - 1/4"	3/8" - 1/4"	1/2" - 1/4"
Minimum pipe length	m		2	2	2
Maximum pipe length	m		20	20	20
Maximum height difference	m		12	12	12
Chargeless pipe length	m		15	15	15
Refrigerant charging(R32)	kg		0.55	0.8	1.10
Power supply	V-ph-Hz		230-1-50	230-1-50	230-1-50

C: cooling mode
H: heating mode

MULTISPLIT



Comfort & flexibility

- Toshiba Inverter multi-split systems feature higher standards of indoor air quality, sound levels and environmental awareness. Special attention has been dedicated to night-time comfort, with the improvement of the silent operation mode, available in indoor units.
- One outdoor unit can serve up to five indoor units for exceptional flexibility and reliability. Toshiba Inverter multi system outdoor units are lightweight and compact. Just one outdoor unit takes up little space on a wall or in a yard. It keeps the exterior of buildings neat with quieter operation. Choose from four types of indoor units, high-wall, ducted, compact 4-way cassette and console type to suit any application.

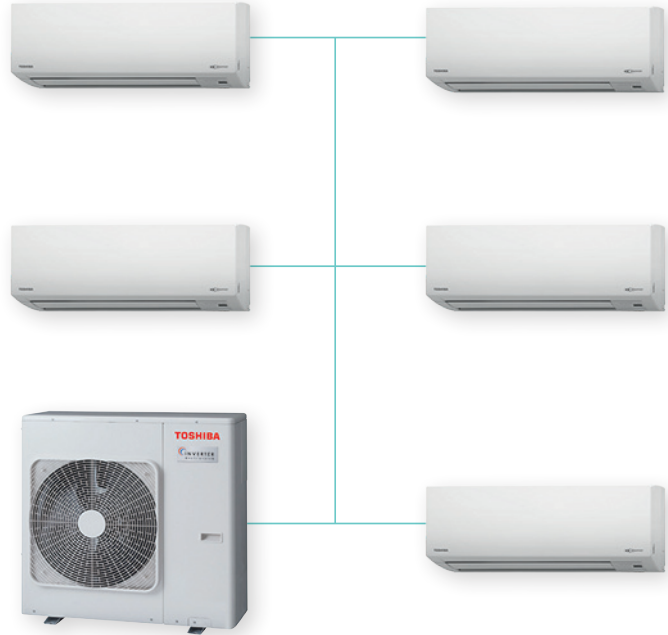

High quality & savings

- Toshiba high-quality multi-split systems contribute to drastically reducing operating costs and increasing energy efficiency. The multi-split outdoor unit achieves efficiency in partial load conditions where the Toshiba inverters deliver their best performance. Toshiba's new super-efficient DC twin-rotary compressor enables top-class performance at low energy Consumption (SEER up to 6.90 & SCOP up to 4.60). With this efficient unit, operating costs decrease dramatically, compared to other multi-split systems.
- Toshiba solutions are studied and verified in every tiny element and are recognised universally by air conditioning professionals for their total reliability. In fact, for Toshiba quality has always been a priority and today and into the future, the quality of Toshiba products will continue to differentiate us from other manufacturers.



Fast and precise temperature management, with Toshiba Twin-rotary Inverter compressors.

MULTISPLIT INVERTER R32 & R410A

Luxury through technology in RAS multi-split inverter systems

- From 2 to 5 rooms with high efficiency product.
- Just one outdoor unit can serve up to five indoor rooms.
- Wide choice of internal units: high-walls, cassettes, duct-type and/or console.
- Compressor DC Twin-Rotary on the whole range.
- Large operating map down to -20°C in heating mode and up to +46°C in cooling.
- Up to 80 meters of frigorific connections for any installation type.
- Full line up available with R32 or R410A.

Space saving & silent

- Toshiba multi-split inverter system outdoor units are lightweight and compact. Just one outdoor unit takes up little space on a wall or in a yard. It keeps the exterior of buildings looking neat and offers quiet operating noise levels.

INDOOR UNITS



IDU (Bi-refrigerant)

- DAISEIKAI 9
- HAORI
- SHORAI EDGE
- SEIYA

- CONSOLE
- DUCT
- Compact CASSETTE

OUTDOOR UNITS



R32

- RAS-2M10U2AVG-E
- RAS-2M14U2AVG-E
- RAS-2M18U2AVG-E
- RAS-3M18U2AVG-E

R32

- RAS-3M26U2AVG-E
- RAS-4M27U2AVG-E
- RAS-5M34U2AVG-E

CONTROLS



Wireless remote controls

Weekly remote control optional

Wired remote control (Cassette & Duct only)



MAX EFFICIENCY



SEER **6.90**

CAPACITY



4kW > 10kW

OPERATION



-20°C > +46°C

RESIDENTIAL AIR-TO-AIR

CHOOSE YOUR ADAPTED SYSTEM SOLUTION



		MULTISPLIT INDOOR UNITS							
Indoor Units sizes		05	07	10	13	16	18	22	24
Indoor Units cooling capacity		1.5 kW	2 kW	2.5 kW	3.5 kW	4.5 kW	5.0 kW	6.0 kW	7.0 kW
Hi-wall - DAISEIKAI 9 R32 & R410A RAS-M**PKVPG-E/TR				•	•	•			
Hi-wall - HAORI R32 RAS-B**N4KVRG-E/TR				•	•	•			
Hi-wall - SHORAI Edge R32 RAS-B**J2KVSG-E/TR		•	•	•	•	•		•	•
Hi-wall - SEIYA R32 RAS-B**J2KVG-E/TR		•	•	•	•	•			
Console R32 & R410A RAS-B**J2FVG-E/TR				•	•		•		
New Compact Cassette R32 & R410A RAS-M**U2MUVG-E/TR				•	•	•			
Ducted R32 & R410A RAS-M**U2DVG-E1/TR			•	•	•	•		•	•

• : Indoor units available sizes

		MULTISPLIT OUTDOOR							
Outdoor Units sizes		05	07	10	13	16	18	22	24
Outdoor units Cooling capacity		1.5 kW	2 kW	2.5 kW	3.5 kW	4.5 kW	5.0 kW	6.0 kW	7.0 kW
2 Rooms R32 RAS-2M10U2AVG-E/TR CDU Cooling capacity: 3.3 kW		•	•	•					
2 Rooms R32 RAS-2M14U2AVG-E/TR CDU Cooling capacity: 4.0 kW		•	•	•	•				
2 Rooms R32 RAS-2M18U2AVG-E/TR CDU Cooling capacity: 5.2 kW		•	•	•	•	•			
3 Rooms R32 RAS-3M18U2AVG-E/TR CDU Cooling capacity: 5.2 kW		•	•	•	•	•			
3 Rooms R32 RAS-3M26U2AVG-E/TR CDU Cooling capacity: 7.5 kW		•	•	•	•	•	•	•	•
4 Rooms R32 RAS-4M27U2AVG-E/TR CDU Cooling capacity: 8.0 kW		•	•	•	•	•	•	•	•
5 Rooms R32 RAS-5M34U2AVG-E/TR CDU Cooling capacity: 10.0 kW		•	•	•	•	•	•	•	•

• : Indoor units sizes compatibility with outdoor units

COMPATIBILITIES	2 ROOMS			3 ROOMS		4 ROOMS	5 ROOMS
	RAS-2M10U2AVG-E/TR	RAS-2M14U2AVG-E/TR	RAS-2M18U2AVG-E/TR	RAS-3M18U2AVG-E/TR	RAS-3M26U2AVG-E/TR	RAS-4M27U2AVG-E/TR	RAS-5M34U2AVG-E/TR
IDU sizes							
05	•	•	•	•	•	•	•
07	•	•	•	•	•	•	•
10	•	•	•	•	•	•	•
13		•	•	•	•	•	•
16			•	•	•	•	•
18					•	•	•
22					•	•	•
24					•	•	•

• : compatibilities



Performance data

Outdoor unit		2-room Multisplit	2-room Multisplit	2-room Multisplit	3-room Multisplit	3-room Multisplit	4-room Multisplit	5-room Multisplit
		RAS-2M10U2AVG-E	RAS-2M14U2AVG-E	RAS-2M18U2AVG-E	RAS-3M18U2AVG-E	RAS-3M26U2AVG-E	RAS-4M27U2AVG-E	RAS-5M34U2AVG-E
		RAS-2M10U2AVG-TR	RAS-2M14U2AVG-TR	RAS-2M18U2AVG-TR	RAS-3M18U2AVG-TR	RAS-3M26U2AVG-TR	RAS-4M27U2AVG-TR	RAS-5M34U2AVG-TR
Cooling capacity	kW	3.3	4.0	5.2	5.2	7.5	8.0	10.0
Cooling capacity (min. - max.)	kW	1.25 - 3.9	1.6 - 4.9	1.7 - 6.2	2.4 - 6.5	4.1 - 9.0	4.2 - 9.3	3.7 - 11.0
Power input	kW C	0.76	0.92	1.34	1.17	2.00	2.29	2.98
EER	W/W	4.35	4.35	3.88	4.44	3.75	3.50	3.36
SEER		6.73	6.73	6.90	6.8	6.19	6.11	6.31
Energy efficiency class	C	A++	A++	A++	A++	A++	A++	A++
Heating capacity	kW	4.0	4.4	5.6	6.8	9.0	9.0	12.0
Heating capacity (min. - max.)	kW	1.00 - 4.90	1.30 - 5.20	1.30 - 7.50	1.90 - 8.00	2.0 - 11.2	2.9 - 11.7	2.7 - 14.0
Power input	kW H	0.81	0.89	1.19	1.58	2.20	1.93	2.83
COP	W/W	4.94	4.94	4.71	4.30	4.09	4.67	4.24
SCOP		4.60	4.60	4.60	4.60	4.44	4.26	4.08
Energy efficiency class	H	A++	A++	A++	A++	A+	A+	A+

Physical data outdoor

Outdoor unit		2-room Multisplit	2-room Multisplit	2-room Multisplit	3-room Multisplit	3-room Multisplit	4-room Multisplit	5-room Multisplit
		RAS-2M10U2AVG-E	RAS-2M14U2AVG-E	RAS-2M18U2AVG-E	RAS-3M18U2AVG-E	RAS-3M26U2AVG-E	RAS-4M27U2AVG-E	RAS-5M34U2AVG-E
		RAS-2M10U2AVG-TR	RAS-2M14U2AVG-TR	RAS-2M18U2AVG-TR	RAS-3M18U2AVG-TR	RAS-3M26U2AVG-TR	RAS-4M27U2AVG-TR	RAS-5M34U2AVG-TR
Air flow	m ³ /h - l/s C	1863-517	1863-517	2107-585	2177-605	2507-696	2507-696	3245-901
Sound pressure level	dB(A) C	45	45	47	49	48	48	52
Sound power level	dB(A) C	58	58	60	62	63	63	66
Operating range	°C C	-10/46	-10/46	-10/46	-10/46	-10/46	-10/46	-10/46
Air flow	m ³ /h - l/s H	1863-517	1863-517	2038-566	2107-585	2507-696	2507-696	3666-1018
Sound pressure level	dB(A) H	46	46	50	50	49	49	55
Sound power level	dB(A) H	59	59	63	63	64	64	68
Operating range	°C H	-20/24	-20/24	-20/24	-20/24	-15/24	-15/24	-15/24
Dimensions (HxWxD)	mm	630 x 800 x 300	630 x 800 x 300	630 x 800 x 300	630 x 800 x 300	890 x 900 x 320	890 x 900 x 320	890 x 900 x 320
Weight	kg	38	43	45	46	72	72	78
Compressor type		DC Single Rotary	DC Twin Rotary	DC Twin Rotary	DC Twin Rotary	DC Twin Rotary	DC Twin Rotary	DC Twin Rotary
Flare connections - gas		1/4" x 2	1/4" x 2	1/4" x 2	1/4" x 2	3/8" x 1 + 1/2"x2	3/8" x 2 + 1/2"x2	3/8" x 3 + 1/2"x2
Flare connections - liquid		3/8" x 2	3/8" x 2	3/8" x 2	3/8" x 2 + 1/2"x1	1/4" x 3	1/4" x 4	1/4" x 5
Maximum pipe length (per unit/total)	m	15/20	20/30	20/30	25/50	25/ 70	25 / 70	25 / 80
Maximum height difference	m	10	10	10	10	15	15	15
Refrigerant charge	kg	0.85	1.02	1.02	1.05	1.92	1.92	2.39
Chargeless pipe length	m	20	30	30	50	40	40	40
Power supply	V-ph-Hz	220/240-1-50	220/240-1-50	220/240-1-50	220/240-1-50	220/240-1-50	220/240-1-50	220/240-1-50

C: cooling mode
H: heating mode
E: European Union
TR: Turkey

RAS MULTI INDOOR UNITS



- Toshiba indoor air quality with Plasma Air Purifier
- 3D airflow with 6 unique airflow patterns
- Silent operation outdoor unit
- Wireless remote control adaptor inside FCU
- Self-cleaning function / Weekly timer / 8°C button
- Extremely silent operation

Physical data indoor

Indoor unit			RAS-M10PKVPG-E RAS-M10PKVPG-TR	RAS-M13PKVPG-E RAS-M13PKVPG-TR	RAS-M16PKVPG-E RAS-M16PKVPG-TR
Air flow	m³/h - l/s	C	672 - 187	672 - 187	672 - 187
Sound pressure level (h/l)	dB(A)	C	42/20	43/20	44/23
Sound power level (h/l)	dB(A)	C	57	58	59
Air flow	m³/h - l/s	H	726 - 202	726 - 202	642 - 178
Sound pressure level (h/l)	dB(A)	H	44/20	44/20	45/23
Sound power level (h/l)	dB(A)	H	59	59	60
Dimensions (h x w x d)	mm		293 x 851 x 270	293 x 851 x 270	293 x 851 x 270
Weight	kg		14	14	14
Flare connections (gas-liquid)			3/8" - 1/4"	3/8" - 1/4"	3/8" - 1/4"



- Truly Elegant design featuring a stylish textile fabric cover
- Toshiba Ultra Pure Filter PM 2.5 & Toshiba Plasma Ionizer
- Toshiba HAORI luxury remote control
- Wifi adaptor inside FCU
- Silent operation

Physical data indoor

Indoor unit	RAS-		RAS-B10N4KVRG-E RAS-B10N4KVRG-TR	RAS-B13N4KVRG RAS-B13N4KVRG-TR	RAS-B16N4KVRG-E RAS-B16N4KVRG-TR
Air flow	m³/h - l/s	C	600 - 166	670 - 186	690 - 180
Sound pressure level (h/l)	dB(A)	C	41/19	43/19	45/21
Sound power level (h/l)	dB(A)	C	54	56	58
Air flow	m³/h - l/s	H	610 - 169	680 - 189	730 - 186
Sound pressure level (h/l)	dB(A)	H	41/19	43/19	45/22
Sound power level (h)	dB(A)	H	54	56	58
Dimensions (h x w x d)	mm		300 x 987 x 210	300 x 987 x 210	300 x 987 x 210
Weight	kg		11	11	12
Flare connections (gas-liquid)			3/8" - 1/4"	3/8" - 1/4"	1/2" - 1/4"



- Toshiba Ultra Pure Filter PM2.5
- 3D airflow with 6 unique airflow patterns (22k&24k)
- Wifi adaptor inside FCU
- HADA care flow
- Silent operation

Physical data indoor

Indoor unit	RAS-		RAS-M05J2KVSG-E RAS-M05J2KVSG-TR	RAS-B07J2KVSG-E RAS-M07J2KVSG-TR	RAS-B10J2KVSG-E RAS-M10J2KVSG-TR	RAS-B13J2KVSG-E RAS-M13J2KVSG-TR	RAS-B16J2KVSG-E RAS-M16J2KVSG-TR	RAS-B16J2KVSG-E RAS-M16J2KVSG-TR	RAS-B16J2KVSG-E RAS-M16J2KVSG-TR
Air flow	m³/h - l/s	C	606 - 168	660 - 183	660 - 183	732 - 203	750 - 208	750 - 208	750 - 208
Sound pressure level (h/l)	dB(A)	C	37/22	40/22	40/22	43/23	44/25	44/25	44/25
Sound power level (h/l)	dB(A)	C	50/35	53/35	53/35	56/36	57/38	57/38	57/38
Air flow	m³/h - l/s	H	606 - 168	660 - 183	660 - 183	732 - 203	768 - 213	768 - 213	768 - 213
Sound pressure level (h/l)	dB(A)	H	37/22	40/22	40/22	43/23	44/26	44/26	44/26
Sound power level (h)	dB(A)	H	50/35	53/35	53/35	56/36	57/39	57/39	57/39
Dimensions (h x w x d)	mm		293 x 800 x 226	293 x 800 x 226	293 x 800 x 226	293 x 800 x 226	293 x 800 x 226	293 x 800 x 226	293 x 800 x 226
Weight	kg		10	10	10	10	10	10	10
Flare connections (gas-liquid)			3/8" - 1/4"	3/8" - 1/4"	3/8" - 1/4"	3/8" - 1/4"	1/2" - 1/4"	1/2" - 1/4"	1/2" - 1/4"



- Elegant compact design
- Self-cleaning function
- Silent operation

Physical data indoor

Indoor unit			RAS-B05J2KVG-E RAS-M05J2KVG-TR	RAS-B07J2KVG-E RAS-M07J2KVG-TR	RAS-B10J2KVG-E RAS-M10J2KVG-TR	RAS-B13J2KVG-E RAS-M13J2KVG-TR	RAS-B16J2KVG-E RAS-M16J2KVG-TR
Air flow	m³/h - l/s	C	510 - 142	522 - 145	540 - 150	600 - 167	750 - 208
Sound pressure level (h/l)	dB(A)	C	37/22	38/23	39/24	41/24	43/25
Sound power level (h/l)	dB(A)	C	52/37	53/38	54/39	56/39	58/40
Air flow	m³/h - l/s	H	522 - 145	534 - 148	552 - 153	618 - 171	768 - 213
Sound pressure level (h/l)	dB(A)	H	37/22	38/23	39/24	42/24	43/25
Sound power level (h/l)	dB(A)	H	52/37	53/38	54/39	57/39	58/40
Dimensions (h x w x d)	mm		293 x 798 x 230	293 x 798 x 230	293 x 798 x 230	293 x 798 x 230	293 x 798 x 230
Weight	kg		9	9	9	9	10
Flare connections (gas-liquid)			3/8" - 1/4"	3/8" - 1/4"	3/8" - 1/4"	3/8" - 1/4"	1/2" - 1/4"

C: cooling mode
H: heating mode

INDOOR UNITS

CONSOLE



- Bi-flow air delivery system (floor heating)
- Silent operation outdoor unit
- Wireless remote control
- R32 refrigerant gas sensor accessory inside FCU (RB-I301-E)

Physical data indoor

Indoor unit			RAS-B10J2FVG-E RAS-M10J2FVG-TR	RAS-B13J2FVG-E RAS-M13J2FVG-TR	RAS-B18J2FVG-E RAS-M18J2FVG-TR
Air Flow	m ³ /h - l/s	C	468 - 130	510 - 142	600 - 167
Sound pressure level (h/l)	dB(A)	C	39/23	40/24	46/31
Sound power level (h/l)	dB(A)	C	54/38	55/39	60/46
Air Flow	m ³ /h - l/s	H	510 - 142	552 - 153	642 - 178
Sound pressure level (h/l)	dB(A)	H	39/23	40/24	46/31
Sound power level (h/l)	dB(A)	H	54/38	55/39	60/46
Dimensions (h x w x d)	mm		600 x 700 x 220	600 x 700 x 220	600 x 700 x 220
Weight	kg		16	16	16
Flare connections (gas-liquid)			3/8" - 1/4"	3/8" - 1/4"	1/2" - 1/4"

C: cooling mode
H: heating mode

COMPACT CASSETTE



- 4 way air diffusion grille
- Elegant Flat Panel modern design & Compact dimensions to suit 600x600mm grid ceilings
- Wired or Wireless remote control / Occupancy sensor option
- Individual louver control / Dual & cycle swing
- Condensate drain pump included (up to 850mm height)

Physical data indoor

Indoor unit			RAS-M10U2MUVG-E RAS-M10U2MUVG-TR	RAS-M13U2MUVG-E RAS-M13U2MUVG-TR	RAS-M16U2MUVG-E RAS-M16U2MUVG-TR
Air flow (h/l)	m ³ /h	C	590/430	620/430	680/450
Sound pressure level (h/l)	dB(A)	C	37/30	38/30	41/31
Sound power level	dB(A)	C	52/45	53/45	56/46
Air flow (h/l)	m ³ /h	H	590/430	620/430	680/450
Sound pressure level (h/l)	dB(A)	H	37/30	38/30	41/31
Sound power level	dB(A)	H	52/45	53/45	56/46
Dimensions (h x w x d)	mm		256 x 575 x 575	256 x 575 x 575	256 x 575 x 575
Weight	kg		15	15	15
Flare connections (gas - liquid)			3/8" - 1/4"	3/8" - 1/4"	1/2" - 1/4"

C: cooling mode
H: heating mode

DUCTED

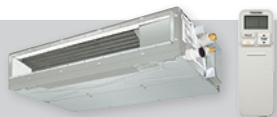

- Slim unit (only 210mm height)
- Adjustable external static pressure
- Condensate drain pump included (up to 350mm height)
- Air filters in option

Indoor unit			RAS-M07U2DVG-E RAS-M07U2DVG-TR	RAS-M10U2DVG-E RAS-M10U2DVG-TR	RAS-M13U2DVG-E RAS-M13U2DVG-TR	RAS-M16U2DVG-E RAS-M16U2DVG-TR	RAS-M22U2DVG-E RAS-M22U2DVG-TR	RAS-M24U2DVG-E RAS-M24U2DVG-TR
Air flow (h/l)	m ³ /h	C	570 / 380	570 / 380	610 / 385	780 / 420	1000/740	1060/760
Sound pressure level (h/l) *1	dB(A)	C	35 / 27	35 / 27	37 / 27	35 / 24	38/32	39/33
Sound power level (h/l) *1	dB(A)	C	50 / 42	50 / 42	52 / 42	50 / 39	53/47	54/48
Air flow (h/l)	m ³ /h - l/s	H	570 / 380	570 / 380	610 / 385	780 / 450	1000/740	1060/760
Sound pressure level (h/l) *1	dB(A)	H	35 / 27	35 / 27	37 / 27	35 / 25	38/32	39/33
Sound power level (h/l) *1	dB(A)	H	50 / 42	50 / 42	52 / 42	50 / 40	53/47	54/48
Dimensions (h x w x d)	mm		210 x 700 x 450	210 x 700 x 450	210 x 700 x 450	210 x 900 x 450	210 x 1100 x 450	210 x 1100 x 450
Weight	kg		16	16	16	19	22	22
Flare connections (gas - liquid)			3/8" - 1/4"	3/8" - 1/4"	3/8" - 1/4"	1/2" - 1/4"	1/2" - 1/4"	1/2" - 1/4"
External static pressure (stand / middle1 / middle2 / upper)	Pa		10 / 20 / 35 /45	10 / 20 / 35 /45	10 / 20 / 35 /45	10 / 20 / 35 /45	10 / 20 / 35 /45	10 / 20 / 35 /45

C: cooling mode
H: heating mode
*1:Back in Take. External static pressure 35Pa.

OPTIONAL



Wireless
Weekly Remote control

RB-RXS33-E
for SEIYA



Wall mounted
Weekly Remote control
(Cassette & Duct only)

RB-RWS21-E

RAS-4M27U2AVG-E / TR - Performances in Cooling mode

Operating Status	Combination				Unit capacity (kW)				Cooling capacity (kW)			Power input (W)			Operating current (A)		EER	Seasonal efficiencies*		
	Unit A	Unit B	Unit C	Unit D	Unit A	Unit B	Unit C	Unit D	Min.	Nom.	Max.	Min.	Nom.	Max.	Nom.	Nom.	Pdc	SEER	Class	
13	10	10	05	05	2.69	1.96	1.96	1.09	4.0	7.7	9.0	950	2200	2730	10.07	3.50	7.7	6.07	A+	
16	10	10	05	05	3.12	1.87	1.87	1.04	4.0	7.9	9.2	950	2260	2790	10.34	3.50	7.9	6.10	A++	
18	10	10	05	05	3.32	1.79	1.79	1.00	4.0	7.9	9.2	950	2260	2790	10.34	3.50	7.9	6.07	A+	
13	13	10	05	05	2.52	2.52	1.84	1.02	4.0	7.9	9.2	950	2260	2790	10.34	3.50	7.9	6.10	A++	
16	13	10	05	05	2.87	2.36	1.72	0.96	4.0	7.9	9.3	950	2260	2820	10.34	3.50	7.9	6.10	A++	
18	13	10	05	05	3.06	2.27	1.65	0.92	4.0	7.9	9.3	950	2260	2820	10.34	3.50	7.9	6.07	A+	
16	16	10	05	05	2.69	2.69	1.62	0.90	4.0	7.9	9.3	950	2260	2820	10.34	3.50	7.9	6.10	A++	
18	16	10	05	05	2.88	2.59	1.56	0.86	4.0	7.9	9.3	950	2260	2820	10.34	3.50	7.9	6.07	A+	
18	18	10	05	05	2.78	2.78	1.50	0.83	4.0	7.9	9.3	950	2260	2820	10.34	3.50	7.9	6.05	A+	
13	13	13	05	05	2.32	2.32	2.32	0.94	4.0	7.9	9.3	950	2260	2820	10.34	3.50	7.9	6.10	A++	
16	13	13	05	05	2.65	2.18	2.18	0.88	4.0	7.9	9.3	950	2260	2820	10.34	3.50	7.9	6.10	A++	
18	13	13	05	05	2.84	2.10	2.10	0.85	4.0	7.9	9.3	950	2260	2820	10.34	3.50	7.9	6.07	A+	
16	16	13	05	05	2.50	2.50	2.06	0.83	4.0	7.9	9.3	950	2260	2820	10.34	3.50	7.9	6.10	A++	
18	16	13	05	05	2.72	2.45	2.01	0.82	4.0	8.0	9.3	950	2290	2890	10.48	3.49	8.0	6.08	A+	
07	07	07	07	07	1.78	1.78	1.78	1.78	4.0	7.1	8.6	890	2029	2620	9.29	3.50	7.1	5.98	A+	
10	07	07	07	07	2.33	1.72	1.72	1.72	4.0	7.5	8.7	890	2143	2640	9.81	3.50	7.5	6.05	A+	
13	07	07	07	07	2.90	1.57	1.57	1.57	4.1	7.6	8.9	900	2171	2700	9.94	3.50	7.6	6.05	A+	
16	07	07	07	07	3.30	1.47	1.47	1.47	4.1	7.7	9.0	930	2200	2730	10.07	3.50	7.7	6.07	A+	
18	07	07	07	07	3.55	1.42	1.42	1.42	4.1	7.8	9.1	930	2229	2760	10.20	3.50	7.8	6.06	A+	
10	10	07	07	07	2.18	2.18	1.62	1.62	4.1	7.6	8.9	900	2171	2700	9.94	3.50	7.6	6.05	A+	
13	10	07	07	07	2.74	2.00	1.48	1.48	4.1	7.7	9.0	930	2200	2730	10.07	3.50	7.7	6.07	A+	
16	10	07	07	07	3.13	1.88	1.39	1.39	4.1	7.8	9.1	930	2229	2760	10.20	3.50	7.8	6.09	A+	
18	10	07	07	07	3.38	1.82	1.35	1.35	4.1	7.9	9.2	940	2257	2790	10.33	3.50	7.9	6.08	A+	
13	13	07	07	07	2.56	2.56	1.39	1.39	4.1	7.9	9.2	940	2257	2790	10.33	3.50	7.9	6.10	A++	
16	13	07	07	07	2.91	2.40	1.30	1.30	4.2	7.9	9.3	950	2257	2820	10.33	3.50	7.9	6.09	A+	
18	13	07	07	07	3.11	2.30	1.24	1.24	4.2	7.9	9.3	950	2257	2820	10.33	3.50	7.9	6.06	A+	
16	16	07	07	07	2.73	2.73	1.22	1.22	4.2	7.9	9.3	950	2257	2820	10.33	3.50	7.9	6.09	A+	
18	16	07	07	07	2.93	2.63	1.17	1.17	4.2	7.9	9.3	950	2257	2820	10.33	3.50	7.9	6.06	A+	
18	18	07	07	07	2.82	2.82	1.13	1.13	4.2	7.9	9.3	950	2257	2820	10.33	3.50	7.9	6.04	A+	
10	10	10	07	07	2.03	2.03	2.03	1.50	4.1	7.6	8.9	900	2171	2700	9.94	3.50	7.6	6.05	A+	
13	10	10	07	07	2.60	1.90	1.90	1.41	4.1	7.8	9.1	930	2229	2760	10.20	3.50	7.8	6.09	A+	
16	10	10	07	07	2.99	1.79	1.79	1.33	4.1	7.9	9.2	940	2257	2790	10.33	3.50	7.9	6.10	A++	
18	10	10	07	07	3.19	1.72	1.72	1.27	4.2	7.9	9.3	950	2257	2820	10.33	3.50	7.9	6.06	A+	
13	13	10	07	07	2.42	2.42	1.76	1.31	4.2	7.9	9.3	950	2257	2820	10.33	3.50	7.9	6.09	A+	
16	13	10	07	07	2.76	2.27	1.65	1.22	4.2	7.9	9.3	950	2257	2820	10.33	3.50	7.9	6.09	A+	
18	13	10	07	07	2.95	2.18	1.59	1.18	4.2	7.9	9.3	950	2257	2820	10.33	3.50	7.9	6.06	A+	
16	16	10	07	07	2.59	2.59	1.56	1.15	4.2	7.9	9.3	950	2257	2820	10.33	3.50	7.9	6.09	A+	
18	16	10	07	07	2.78	2.50	1.50	1.11	4.2	7.9	9.3	950	2257	2820	10.33	3.50	7.9	6.06	A+	
18	18	10	07	07	2.72	2.72	1.47	1.09	4.2	8.0	9.3	950	2286	2820	10.46	3.50	8.0	6.05	A+	
13	13	13	07	07	2.23	2.23	2.23	1.21	4.2	7.9	9.3	950	2257	2820	10.33	3.50	7.9	6.09	A+	
16	13	13	07	07	2.56	2.10	2.10	1.14	4.2	7.9	9.3	950	2257	2820	10.33	3.50	7.9	6.09	A+	
18	13	13	07	07	2.74	2.03	2.03	1.10	4.2	7.9	9.3	950	2257	2820	10.33	3.50	7.9	6.06	A+	
16	16	13	07	07	2.45	2.45	2.01	1.09	4.2	8.0	9.3	950	2286	2820	10.46	3.50	8.0	6.11	A++	
18	16	13	07	07	2.63	2.37	1.95	1.05	4.2	8.0	9.3	950	2286	2820	10.46	3.50	8.0	6.08	A+	
10	10	10	10	10	1.98	1.98	1.98	1.98	4.1	7.9	9.2	940	2257	2790	10.33	3.50	7.9	6.10	A++	
13	10	10	10	10	2.48	1.81	1.81	1.81	4.1	7.9	9.2	940	2257	2790	10.33	3.50	7.9	6.10	A++	
16	10	10	10	10	2.82	1.69	1.69	1.69	4.2	7.9	9.3	950	2257	2820	10.33	3.50	7.9	6.09	A+	
18	10	10	10	10	3.02	1.63	1.63	1.63	4.2	7.9	9.3	950	2257	2820	10.33	3.50	7.9	6.06	A+	
13	13	10	10	10	2.28	2.28	1.67	1.67	4.2	7.9	9.3	950	2257	2820	10.33	3.50	7.9	6.09	A+	
16	13	10	10	10	2.61	2.15	1.57	1.57	4.2	7.9	9.3	950	2257	2820	10.33	3.50	7.9	6.09	A+	
18	13	10	10	10	2.80	2.07	1.51	1.51	4.2	7.9	9.3	950	2257	2820	10.33	3.50	7.9	6.06	A+	
16	16	10	10	10	2.50	2.50	1.50	1.50	4.2	8.0	9.3	950	2286	2820	10.46	3.50	8.0	6.11	A++	
18	16	10	10	10	2.68	2.42	1.45	1.45	4.2	8.0	9.3	950	2286	2820	10.46	3.50	8.0	6.08	A+	
13	13	13	10	10	2.12	2.12	2.12	1.55	4.2	7.9	9.3	950	2257	2820	10.33	3.50	7.9	6.09	A+	
16	13	13	10	10	2.47	2.03	2.03	1.48	4.2	8.0	9.3	950	2286	2820	10.46	3.50	8.0	6.11	A++	
18	13	13	10	10	2.65	1.96	1.96	1.43	4.2	8.0	9.3	950	2286	2820	10.46	3.50	8.0	6.08	A+	
13	13	13	13	13	2.00	2.00	2.00	2.00	4.2	8.0	9.3	950	2286	2820	10.46	3.50	8.0	6.11	A++	
22	05*	05*	05*	05*	4.51	1.13	1.13	1.13	4.0	7.9	9.0	950	2200	2760	10.07	3.59	7.9	6.10	A++	
24	05*	05*	05*	05*	4.84	1.02	1.02	1.02	4.0	7.9	9.0	950	2220	2770	10.16	3.56	7.9	6.09	A+	
22	07*	05*	05*	05*	4.31	1.44	1.08	1.08	4.0	7.9	9.3	950	2210	2760	10.11	3.57	7.9	6.10	A++	
24	07*	05*	05*	05*	4.64	1.31	0.98	0.98	4.0	7.9	9.3	950	2230	2760	10.21	3.54	7.9	6.09	A+	
22	10*	05*	05*	05*	4.05	1.82	1.01	1.01	4.0	7.9	9.3	950	2220	2770	10.16	3.56	7.9	6.10	A++	
24	10*	05*	05*	05*	4.38	1.67	0.93	0.93	4.0	7.9	9.3	950	2220	2770	10.16	3.56	7.9	6.09	A+	
22	13*	05*	05*	05*	3.73	2.30	0.93	0.93	4.0	7.9	9.3	950	2220	2770	10.16	3.56	7.9	6.10	A++	
24	13*	05*	05*	05*	4.06	2.12	0.86	0.86	4.0	7.9	9.3	950	2220	2770	10.16	3.56	7.9	6.09	A+	
22	07*	07*	05*	05*	4.12	1.37	1.37	1.03	4.0	7.9	9.3	950	2220	2770	10.16	3.56	7.9	6.10	A++	
24	07*	07*	05*	05*	4.45	1.25	1.25	0.94	4.0	7.9	9.3	950	2220	2770	10.16	3.56	7.9	6.09	A+	
22	10*	07*	05*	05*	3.89	1.75	1.30	0.97	4.0	7.9	9.3	950	2220	2770	10.16	3.56	7.9	6.10	A++	
24	10*	07*	05*	05*	4.22	1.60	1.19	0.89	4.0	7.9	9.3	950	2220	2770	10.16	3.56	7.9	6.09	A+	
22	13*	07*	05*	05*	3.59	2.21	1.20	0.90	4.0	7.9	9.3	950	2220	2770	10.16	3.56	7.9	6.10	A++	
24	13*	07*	05*	05*	3.92	2.04	1.10	0.83	4.0	7.9	9.3	950	2220	2770	10.16	3.56	7.9	6.09	A+	
22	10*	10*	05*	05*	3.67	1.65	1.65	0.92	4.0	7.9	9.3	950	2220</							



RAS-4M27U2AVG-E / TR - Performances in Heating mode

Operating Status	Combination				Unit capacity (kW)				Cooling capacity (kW)			Power input (W)		Operating current (A)		EER	Seasonal efficiencies*			
	Unit A	Unit B	Unit C	Unit D	Unit A	Unit B	Unit C	Unit D	Min.	Nom.	Max.	Min.	Nom.	Max.	Nom.	Max.	Nom.	Pdc	SEER	Class
1 unit operation	05	-	-	-	2.00	-	-	-	0.8	2.0	2.7	300	600	900	3.00	-	-	-	-	-
	07	-	-	-	2.70	-	-	-	0.8	2.7	4.8	300	900	1980	4.50	-	-	-	-	-
	10	-	-	-	4.00	-	-	-	0.8	4.0	5.2	300	1450	1980	6.64	-	-	-	-	-
	13	-	-	-	5.00	-	-	-	0.8	5.0	6.5	310	2050	2750	9.38	-	-	-	-	-
	16	-	-	-	5.50	-	-	-	0.8	5.5	6.9	310	2400	3000	10.98	-	-	-	-	-
	18	-	-	-	6.00	-	-	-	0.8	6.0	7.1	310	2630	3200	12.04	-	-	-	-	-
	22	-	-	-	7.00	-	-	-	1.8	7.0	8.2	330	2620	3200	11.99	-	-	-	-	-
	24	-	-	-	8.10	-	-	-	1.8	8.1	8.6	330	3080	3300	14.10	-	-	-	-	-
2 units operations	05	05	-	-	2.00	2.00	-	-	1.5	4.0	5.0	320	1300	1500	5.95	3.08	3.5	4.04	A+	
	07	05	-	-	2.70	2.00	-	-	1.5	4.7	6.0	320	1500	1700	6.86	3.13	4.0	4.13	A+	
	10	05	-	-	4.00	2.00	-	-	1.5	6.0	7.4	320	1800	2600	8.24	3.33	4.5	4.21	A+	
	13	05	-	-	5.00	2.00	-	-	1.5	7.0	8.9	320	2150	2700	9.84	3.26	4.5	4.21	A+	
	16	05	-	-	5.50	2.00	-	-	1.5	7.5	10.1	320	2320	2800	10.62	3.23	4.7	4.30	A+	
	18	05	-	-	6.00	2.00	-	-	1.5	8.0	10.1	320	2480	3100	11.35	3.23	4.7	4.30	A+	
	22	05	-	-	6.46	1.84	-	-	1.5	8.3	10.2	320	2700	3230	12.36	3.07	4.7	4.20	A+	
	24	05	-	-	6.66	1.64	-	-	1.5	8.3	10.2	320	2700	3230	12.36	3.07	4.7	4.20	A+	
	07	07	-	-	2.70	2.70	-	-	1.5	5.4	7.4	320	1800	2500	8.24	3.00	4.5	4.21	A+	
	10	07	-	-	4.00	2.70	-	-	1.5	6.7	8.9	320	2080	3200	9.52	3.22	4.5	4.21	A+	
	13	07	-	-	4.81	2.59	-	-	1.5	7.4	10.1	320	2320	3210	10.62	3.19	4.7	4.30	A+	
	16	07	-	-	5.10	2.50	-	-	1.5	7.6	10.1	320	2480	3230	11.35	3.06	4.7	4.30	A+	
	18	07	-	-	5.45	2.45	-	-	1.5	7.9	10.1	320	2480	3230	11.35	3.19	4.7	4.30	A+	
	22	07	-	-	5.70	2.20	-	-	1.5	7.9	10.1	320	2480	3230	11.35	3.19	4.7	4.20	A+	
	24	07	-	-	6.23	2.08	-	-	1.5	8.3	10.2	320	2700	3240	12.36	3.07	4.7	4.20	A+	
	10	10	-	-	3.60	3.60	-	-	1.5	7.2	10.0	320	2100	3200	9.61	3.43	4.7	4.30	A+	
	13	10	-	-	4.22	3.38	-	-	1.5	7.6	10.1	320	2320	3210	10.62	3.28	4.7	4.30	A+	
	16	10	-	-	4.57	3.33	-	-	1.5	7.9	10.1	320	2480	3230	11.35	3.19	4.7	4.30	A+	
	18	10	-	-	4.74	3.16	-	-	1.5	7.9	10.1	320	2480	3230	11.35	3.19	4.7	4.30	A+	
	22	10	-	-	5.28	3.02	-	-	1.5	8.3	10.2	320	2700	3240	12.36	3.07	4.7	4.20	A+	
	24	10	-	-	5.76	2.84	-	-	1.5	8.6	10.2	320	2860	3250	13.09	3.01	4.7	4.20	A+	
	13	13	-	-	3.95	3.95	-	-	1.5	7.9	10.1	320	2480	3230	11.35	3.19	4.7	4.30	A+	
	16	13	-	-	4.35	3.95	-	-	1.5	8.3	10.2	320	2700	3240	12.36	3.07	4.7	4.30	A+	
	18	13	-	-	4.53	3.77	-	-	1.5	8.3	10.2	320	2700	3240	12.36	3.07	4.7	4.30	A+	
	22	13	-	-	5.02	3.58	-	-	1.5	8.6	10.2	320	2860	3250	13.09	3.01	4.7	4.20	A+	
	24	13	-	-	5.32	3.28	-	-	1.5	8.6	10.2	320	2860	3250	13.09	3.01	4.7	4.20	A+	
	16	16	-	-	4.30	4.30	-	-	1.5	8.6	10.2	320	2860	3250	13.09	3.01	4.7	4.30	A+	
	18	16	-	-	4.49	4.11	-	-	1.5	8.6	10.2	320	2860	3250	13.09	3.01	4.7	4.30	A+	
	22	16	-	-	4.82	3.78	-	-	1.5	8.6	10.2	320	2860	3250	13.09	3.01	4.7	4.20	A+	
	24	16	-	-	5.12	3.48	-	-	1.5	8.6	10.2	320	2860	3250	13.09	3.01	4.7	4.20	A+	
	18	18	-	-	4.30	4.30	-	-	1.5	8.6	10.2	320	2860	3250	13.09	3.01	4.7	4.29	A+	
	22	18	-	-	4.63	3.97	-	-	1.5	8.6	10.2	320	2860	3250	13.09	3.01	4.7	4.19	A+	
24	18	-	-	4.94	3.66	-	-	1.5	8.6	10.2	320	2860	3250	13.09	3.01	4.7	4.19	A+		
05	05	05	-	2.00	2.00	2.00	-	2.0	6.0	9.0	380	1470	2100	6.73	4.08	4.7	4.42	A+		
07	05	05	-	2.70	2.00	2.00	-	2.0	6.7	9.5	380	1650	2400	7.55	4.06	4.7	4.42	A+		
10	05	05	-	4.00	2.00	2.00	-	2.0	8.0	10.5	380	2100	2760	9.61	3.81	4.7	4.42	A+		
13	05	05	-	4.72	1.89	1.89	-	2.0	8.5	10.5	380	2250	2760	10.30	3.78	5.2	4.42	A+		
16	05	05	-	4.92	1.79	1.79	-	2.0	8.5	10.5	380	2350	2760	10.76	3.62	5.2	4.42	A+		
18	05	05	-	5.10	1.70	1.70	-	2.0	8.5	10.5	380	2350	2760	10.76	3.62	5.2	4.42	A+		
22	05	05	-	5.60	1.60	1.60	-	2.0	8.8	10.6	380	2450	2780	11.21	3.59	5.2	4.29	A+		
24	05	05	-	5.89	1.45	1.45	-	2.0	8.8	10.6	380	2450	2780	11.21	3.59	5.2	4.28	A+		
07	07	05	-	2.70	2.70	2.00	-	2.0	7.4	10.0	380	1950	2700	8.92	3.79	4.7	4.42	A+		
10	07	05	-	4.00	2.70	2.00	-	2.0	8.7	10.5	380	2300	2760	10.53	3.78	5.2	4.42	A+		
13	07	05	-	4.48	2.42	1.79	-	2.0	8.7	10.5	380	2400	2760	10.98	3.63	5.2	4.42	A+		
16	07	05	-	4.58	2.25	1.67	-	2.0	8.5	10.5	380	2350	2760	10.76	3.62	5.2	4.42	A+		
18	07	05	-	4.77	2.14	1.59	-	2.0	8.5	10.7	380	2400	2790	10.98	3.54	5.2	4.42	A+		
22	07	05	-	5.09	1.96	1.45	-	2.0	8.5	10.7	380	2450	2790	11.21	3.47	5.2	4.29	A+		
24	07	05	-	5.51	1.84	1.36	-	2.0	8.7	10.7	380	2450	2790	11.21	3.55	5.2	4.28	A+		
10	10	05	-	3.40	3.40	1.70	-	2.0	8.5	10.5	380	2350	2760	10.76	3.62	5.2	4.42	A+		
13	10	05	-	4.00	3.20	1.60	-	2.0	8.8	10.5	380	2350	2760	10.76	3.74	5.2	4.42	A+		
16	10	05	-	4.07	2.96	1.48	-	2.0	8.5	10.6	380	2350	2780	10.76	3.62	5.2	4.42	A+		
18	10	05	-	4.25	2.83	1.42	-	2.0	8.5	10.6	380	2350	2780	10.76	3.62	5.2	4.42	A+		
22	10	05	-	4.68	2.68	1.34	-	2.0	8.7	10.6	380	2350	2780	10.76	3.70	5.2	4.29	A+		
24	10	05	-	5.06	2.50	1.25	-	2.0	8.8	10.6	380	2350	2780	10.76	3.74	5.2	4.28	A+		
13	13	05	-	3.54	3.54	1.42	-	2.0	8.5	10.6	380	2350	2780	10.76	3.62	5.2	4.42	A+		
16	13	05	-	3.87	3.52	1.41	-	2.0	8.8	10.6	380	2350	2780	10.76	3.74	5.2	4.42	A+		
18	13	05	-	4.06	3.38	1.35	-	2.0	8.8	10.6	380	2350	2780	10.76	3.74	5.2	4.42	A+		
22	13	05	-	4.45	3.18	1.27	-	2.0	8.9	10.7	380	2450	2790	11.21	3.63	5.2	4.29	A+		
24	13	05	-	4.77	2.95	1.18	-	2.0	8.9	10.7	380	2450	2790	11.21	3.63	5.2	4.28	A+		
16	16	05	-	3.72	3.72	1.35	-	2.0	8.8	10.7	380	2350	2790	10.76	3.74	5.2	4.42	A+		
18	16	05	-	3.96	3.63	1.32	-	2.0	8.9	10.7	380	2350	2790	10.76	3.79	5.2	4.42	A+		
22	16	05	-	4.30	3.38	1.23	-	2.0	8.9	10.7	380	2450	2							

RAS-4M27U2AVG-E / TR - Performances in Heating mode

Operating Status	Combination				Unit capacity (kW)				Cooling capacity (kW)			Power input (W)			Operating current (A)		EER	Seasonal efficiencies*		
	Unit A	Unit B	Unit C	Unit D	Unit A	Unit B	Unit C	Unit D	Min.	Nom.	Max.	Min.	Nom.	Max.	Nom.	Nom.	Pdc	SEER	Class	
3 units operations	10	10	10	-	2.87	2.87	2.87	-	2.0	8.6	10.4	380	2300	2750	10.53	3.74	5.2	4.42	A+	
	13	10	10	-	3.35	2.68	2.68	-	2.0	8.7	10.5	380	2350	2760	10.76	3.70	5.2	4.42	A+	
	16	10	10	-	3.54	2.58	2.58	-	2.0	8.7	10.5	380	2350	2760	10.76	3.70	5.2	4.42	A+	
	18	10	10	-	3.73	2.49	2.49	-	2.0	8.7	10.5	380	2350	2760	10.76	3.70	5.2	4.42	A+	
	22	10	10	-	4.15	2.37	2.37	-	2.0	8.9	10.7	380	2450	2790	11.21	3.63	5.2	4.29	A+	
	24	10	10	-	4.48	2.21	2.21	-	2.0	8.9	10.7	380	2450	2790	11.21	3.63	5.2	4.28	A+	
	13	13	10	-	3.11	3.11	2.49	-	2.0	8.7	10.5	380	2350	2760	10.76	3.70	5.2	4.42	A+	
	16	13	10	-	3.34	3.03	2.43	-	2.0	8.8	10.6	380	2400	2780	10.98	3.67	5.2	4.42	A+	
	18	13	10	-	3.56	2.97	2.37	-	2.0	8.9	10.7	380	2450	2790	11.21	3.63	5.2	4.42	A+	
	22	13	10	-	3.89	2.78	2.23	-	2.0	8.9	10.7	380	2450	2790	11.21	3.63	5.2	4.29	A+	
	24	13	10	-	4.22	2.60	2.08	-	2.0	8.9	10.7	380	2450	2790	11.21	3.63	5.2	4.28	A+	
	16	16	10	-	3.26	3.26	2.37	-	2.0	8.9	10.7	380	2450	2790	11.21	3.63	5.2	4.42	A+	
	18	16	10	-	3.45	3.16	2.30	-	2.0	8.9	10.7	380	2450	2790	11.21	3.63	5.2	4.42	A+	
	22	16	10	-	3.78	2.97	2.16	-	2.0	8.9	10.7	380	2450	2790	11.21	3.63	5.2	4.29	A+	
	24	16	10	-	4.10	2.78	2.02	-	2.0	8.9	10.7	380	2450	2790	11.21	3.63	5.2	4.28	A+	
	18	18	10	-	3.34	3.34	2.23	-	2.0	8.9	10.7	380	2450	2790	11.21	3.63	5.2	4.42	A+	
	22	18	10	-	3.66	3.14	2.09	-	2.0	8.9	10.7	380	2450	2790	11.21	3.63	5.2	4.28	A+	
	24	18	10	-	3.98	2.95	1.97	-	2.0	8.9	10.7	380	2450	2790	11.21	3.63	5.2	4.28	A+	
	13	13	13	-	2.93	2.93	2.93	-	2.0	8.8	10.6	380	2400	2780	10.98	3.67	5.2	4.42	A+	
	16	13	13	-	3.16	2.87	2.87	-	2.0	8.9	10.7	380	2450	2790	11.21	3.63	5.2	4.42	A+	
	18	13	13	-	3.34	2.78	2.78	-	2.0	8.9	10.7	380	2450	2790	11.21	3.63	5.2	4.42	A+	
	22	13	13	-	3.66	2.62	2.62	-	2.0	8.9	10.7	380	2450	2790	11.21	3.63	5.2	4.29	A+	
	24	13	13	-	3.98	2.46	2.46	-	2.0	8.9	10.7	380	2450	2790	11.21	3.63	5.2	4.28	A+	
	16	16	13	-	3.06	3.06	2.78	-	2.0	8.9	10.7	380	2450	2790	11.21	3.63	5.2	4.42	A+	
	18	16	13	-	3.24	2.97	2.70	-	2.0	8.9	10.7	380	2450	2790	11.21	3.63	5.2	4.42	A+	
	22	16	13	-	3.56	2.80	2.54	-	2.0	8.9	10.7	380	2450	2790	11.21	3.63	5.2	4.29	A+	
	24	16	13	-	3.88	2.63	2.39	-	2.0	8.9	10.7	380	2450	2790	11.21	3.63	5.2	4.28	A+	
	18	18	13	-	3.14	3.14	2.62	-	2.0	8.9	10.7	380	2450	2790	11.21	3.63	5.2	4.42	A+	
	22	18	13	-	3.46	2.97	2.47	-	2.0	8.9	10.7	380	2450	2790	11.21	3.63	5.2	4.28	A+	
	16	16	16	-	2.97	2.97	2.97	-	2.0	8.9	10.7	380	2450	2790	11.21	3.63	5.2	4.42	A+	
	18	16	16	-	3.14	2.88	2.88	-	2.0	8.9	10.7	380	2450	2790	11.21	3.63	5.2	4.42	A+	
	22	16	16	-	3.46	2.72	2.72	-	2.0	8.9	10.7	380	2450	2790	11.21	3.63	5.2	4.29	A+	
	05	05	05	05	1.63	1.63	1.63	1.63	2.9	6.5	10.0	501	1400	2000	6.41	4.64	5.2	4.26	A+	
	07	05	05	05	2.33	1.72	1.72	1.72	2.9	7.5	11.0	501	1630	2300	7.46	4.60	5.2	4.26	A+	
	10	05	05	05	3.36	1.68	1.68	1.68	2.9	8.4	11.6	501	1850	2580	8.47	4.54	5.2	4.26	A+	
	13	05	05	05	4.00	1.60	1.60	1.60	2.9	8.8	11.7	501	1880	2590	8.60	4.68	5.2	4.26	A+	
16	05	05	05	4.21	1.53	1.53	1.53	2.9	8.8	11.7	501	1890	2600	8.65	4.66	5.2	4.26	A+		
18	05	05	05	4.40	1.47	1.47	1.47	2.9	8.8	11.7	501	1910	2600	8.74	4.61	5.2	4.25	A+		
07	07	05	05	2.36	2.36	1.74	1.74	2.9	8.2	11.5	501	1800	2500	8.24	4.56	5.2	4.26	A+		
10	07	05	05	3.21	2.17	1.61	1.61	2.9	8.6	11.7	501	1870	2590	8.56	4.60	5.2	4.26	A+		
13	07	05	05	3.76	2.03	1.50	1.50	2.9	8.8	11.7	501	1900	2600	8.70	4.63	5.2	4.26	A+		
16	07	05	05	3.97	1.95	1.44	1.44	2.9	8.8	11.7	501	1910	2600	8.74	4.61	5.2	4.26	A+		
18	07	05	05	4.20	1.89	1.40	1.40	2.9	8.9	11.7	501	1910	2600	8.74	4.66	5.2	4.25	A+		
10	10	05	05	2.93	2.93	1.47	1.47	2.9	8.8	11.7	501	1910	2600	8.74	4.61	5.2	4.26	A+		
13	10	05	05	3.38	2.71	1.35	1.35	2.9	8.8	11.7	501	1910	2600	8.74	4.61	5.2	4.26	A+		
16	10	05	05	3.63	2.64	1.32	1.32	2.9	8.9	11.7	501	1910	2600	8.74	4.66	5.2	4.26	A+		
18	10	05	05	3.81	2.54	1.27	1.27	2.9	8.9	11.7	501	1920	2600	8.79	4.64	5.2	4.25	A+		
13	13	05	05	3.18	3.18	1.27	1.27	2.9	8.9	11.7	501	1920	2600	8.79	4.64	5.2	4.26	A+		
16	13	05	05	3.38	3.07	1.23	1.23	2.9	8.9	11.7	501	1920	2600	8.79	4.64	5.2	4.26	A+		
18	13	05	05	3.56	2.97	1.19	1.19	2.9	8.9	11.7	501	1920	2600	8.79	4.64	5.2	4.25	A+		
16	16	05	05	3.26	3.26	1.19	1.19	2.9	8.9	11.7	501	1920	2600	8.79	4.64	5.2	4.26	A+		
18	16	05	05	3.45	3.16	1.15	1.15	2.9	8.9	11.7	501	1920	2600	8.79	4.64	5.2	4.25	A+		
18	18	05	05	3.34	3.34	1.11	1.11	2.9	8.9	11.7	501	1920	2600	8.79	4.64	5.2	4.25	A+		
07	07	07	05	2.27	2.27	2.27	1.68	2.9	8.5	11.7	501	1850	2580	8.47	4.59	5.2	4.26	A+		
10	07	07	05	3.09	2.08	2.08	1.54	2.9	8.8	11.7	501	1890	2590	8.65	4.66	5.2	4.26	A+		
13	07	07	05	3.55	1.92	1.92	1.42	2.9	8.8	11.7	501	1910	2600	8.74	4.61	5.2	4.26	A+		
16	07	07	05	3.79	1.86	1.86	1.38	2.9	8.9	11.7	501	1910	2600	8.74	4.66	5.2	4.26	A+		
18	07	07	05	3.99	1.79	1.79	1.33	2.9	8.9	11.7	501	1910	2600	8.74	4.66	5.2	4.25	A+		
10	10	07	05	2.77	2.77	1.87	1.39	2.9	8.8	11.7	501	1910	2600	8.74	4.61	5.2	4.26	A+		
13	10	07	05	3.25	2.60	1.75	1.30	2.9	8.9	11.7	501	1920	2600	8.79	4.64	5.2	4.26	A+		
16	10	07	05	3.45	2.51	1.69	1.25	2.9	8.9	11.7	501	1920	2600	8.79	4.64	5.2	4.26	A+		
18	10	07	05	3.63	2.42	1.63	1.21	2.9	8.9	11.7	501	1920	2600	8.79	4.64	5.2	4.25	A+		
13	13	07	05	3.03	3.03	1.63	1.21	2.9	8.9	11.7	501	1920	2600	8.79	4.64	5.2	4.26	A+		
16	13	07	05	3.22	2.93	1.58	1.17	2.9	8.9	11.7	501	1930	2600	8.83	4.61	5.2	4.26	A+		
18	13	07	05	3.40	2.83	1.53	1.13	2.9	8.9	11.7	501	1930	2600	8.83	4.61	5.2	4.25	A+		
16	16	07	05	3.12	3.12	1.53	1.13	2.9	8.9	11.7	501	1930	2600	8.83	4.61	5.2	4.26	A+		
18	16	07	05	3.30	3.02	1.48	1.10	2.9	8.9	11.7	501	1930	2600	8.83	4.61	5.2	4.25	A+		
18	18	07	05	3.20	3.20	1.44	1.07	2.9	8.9	11.7	501	1930	2600	8.83	4.61	5.2	4.25	A+		
10	10	10	05	2.54	2.54	2.54	1.27	2.9	8.9	11.7	501	1920	2600	8.79	4.64	5.2	4.26	A+		
13	10	10	05	2.97	2.37	2.37	1.19	2.9	8.9	11.7	501	1920	2600	8.79	4.64	5.2	4.26	A+		
16	10	10	05	3.16	2.30	2.30	1.15	2.9	8.9	11.7	501	1920	2600	8.79	4.64	5.2	4.26	A+		
18	10	10	05	3.34	2.23	2.23	1.11	2.9	8.9	11.7	501	1920	2600	8.79	4.64	5.2	4.25	A+		
13	13	10	05	2.78	2.78	2.23	1.11	2.9	8.9	11.7	501	1920	2600	8.79	4.64	5.2	4.26	A+		
16	13	10	05	2.97	2.70	2.16	1.08	2.9	8.9	11.7	501	1920	2600	8.79	4.64	5.2	4.26	A+		
18	13	10	05	3.14	2.62	2.09	1.05	2.9	8.9	11.7	501	1920	2600	8.79	4.64	5.2	4.25	A+		
16	16	10	05	2.88	2.88	2.09	1.05	2.9	8.9	11.7	501	1920	2600	8.79	4.64</					



RAS-4M27U2AVG-E / TR - Performances in Heating mode

Operating Status	Combination				Unit capacity (kW)				Cooling capacity (kW)			Power input (W)			Operating current (A)		EER	Seasonal efficiencies*		
	Unit A	Unit B	Unit C	Unit D	Unit A	Unit B	Unit C	Unit D	Min.	Nom.	Max.	Min.	Nom.	Max.	Min.	Nom.		PdC	SEER	Class
Heating, 230 V	16	10	10	07	3.02	2.20	2.20	1.48	2.9	8.9	11.7	501	1905	2600	8.72	4.67	5.2	4.26	A+	
	18	10	10	07	3.20	2.13	2.13	1.44	2.9	8.9	11.7	501	1905	2600	8.72	4.67	5.2	4.25	A+	
	13	13	10	07	2.66	2.66	2.13	1.44	2.9	8.9	11.7	501	1905	2600	8.72	4.67	5.2	4.26	A+	
	16	13	10	07	2.85	2.59	2.07	1.40	2.9	8.9	11.7	501	1905	2600	8.72	4.67	5.2	4.26	A+	
	18	13	10	07	3.02	2.51	2.01	1.36	2.9	8.9	11.7	501	1905	2600	8.72	4.67	5.2	4.25	A+	
	16	16	10	07	2.77	2.77	2.01	1.36	2.9	8.9	11.7	501	1905	2600	8.72	4.67	5.2	4.26	A+	
	18	16	10	07	2.93	2.69	1.96	1.32	2.9	8.9	11.7	501	1905	2600	8.72	4.67	5.2	4.25	A+	
	18	18	10	07	2.89	2.89	1.93	1.30	2.9	9.0	11.7	501	1927	2600	8.82	4.67	5.2	4.25	A+	
	13	13	13	07	2.51	2.51	2.51	1.36	2.9	8.9	11.7	501	1905	2600	8.72	4.67	5.2	4.26	A+	
	16	13	13	07	2.69	2.45	2.45	1.32	2.9	8.9	11.7	501	1905	2600	8.72	4.67	5.2	4.26	A+	
	18	13	13	07	2.86	2.38	2.38	1.29	2.9	8.9	11.7	501	1905	2600	8.72	4.67	5.2	4.25	A+	
	16	16	13	07	2.65	2.65	2.41	1.30	2.9	9.0	11.7	501	1927	2600	8.82	4.67	5.2	4.26	A+	
	18	16	13	07	2.81	2.58	2.34	1.27	2.9	9.0	11.7	501	1927	2600	8.82	4.67	5.2	4.25	A+	
	10	10	10	10	2.18	2.18	2.18	2.18	2.9	8.7	11.6	501	1869	2580	8.55	4.67	5.2	4.26	A+	
	13	10	10	10	2.62	2.09	2.09	2.09	2.9	8.9	11.7	501	1905	2600	8.72	4.67	5.2	4.26	A+	
	16	10	10	10	2.80	2.03	2.03	2.03	2.9	8.9	11.7	501	1905	2600	8.72	4.67	5.2	4.26	A+	
	18	10	10	10	2.97	1.98	1.98	1.98	2.9	8.9	11.7	501	1905	2600	8.72	4.67	5.2	4.25	A+	
	13	13	10	10	2.47	2.47	1.98	1.98	2.9	8.9	11.7	501	1905	2600	8.72	4.67	5.2	4.26	A+	
	16	13	10	10	2.65	2.41	1.92	1.92	2.9	8.9	11.7	501	1905	2600	8.72	4.67	5.2	4.26	A+	
	18	13	10	10	2.81	2.34	1.87	1.87	2.9	8.9	11.7	501	1905	2600	8.72	4.67	5.2	4.25	A+	
	16	16	10	10	2.61	2.61	1.89	1.89	2.9	9.0	11.7	501	1927	2600	8.82	4.67	5.2	4.26	A+	
	18	16	10	10	2.77	2.54	1.85	1.85	2.9	9.0	11.7	501	1927	2600	8.82	4.67	5.2	4.25	A+	
	13	13	13	10	2.34	2.34	2.34	1.87	2.9	8.9	11.7	501	1905	2600	8.72	4.67	5.2	4.26	A+	
	16	13	13	10	2.54	2.31	2.31	1.85	2.9	9.0	11.7	501	1927	2600	8.82	4.67	5.2	4.26	A+	
	18	13	13	10	2.70	2.25	2.25	1.80	2.9	9.0	11.7	501	1927	2600	8.82	4.67	5.2	4.25	A+	
	13	13	13	13	2.25	2.25	2.25	2.25	2.9	9.0	11.7	501	1927	2600	8.82	4.67	5.2	4.26	A+	
	22	05*	05*	05*	4.79	1.37	1.37	1.37	2.9	8.9	11.7	501	1910	2600	8.74	4.66	5.2	4.12	A+	
	24	05*	05*	05*	5.11	1.26	1.26	1.26	2.9	8.9	11.7	501	1920	2600	8.79	4.64	5.2	4.12	A+	
	22	07*	05*	05*	4.55	1.75	1.30	1.30	2.9	8.9	11.7	501	1920	2600	8.79	4.64	5.2	4.12	A+	
	24	07*	05*	05*	4.87	1.62	1.20	1.20	2.9	8.9	11.7	501	1920	2600	8.79	4.64	5.2	4.12	A+	
	22	10*	05*	05*	4.15	2.37	1.19	1.19	2.9	8.9	11.7	501	1920	2600	8.79	4.64	5.2	4.12	A+	
	24	10*	05*	05*	4.48	2.21	1.11	1.11	2.9	8.9	11.7	501	1920	2600	8.79	4.64	5.2	4.12	A+	
	22	13*	05*	05*	3.89	2.78	1.11	1.11	2.9	8.9	11.7	501	1920	2600	8.79	4.64	5.2	4.12	A+	
	24	13*	05*	05*	4.22	2.60	1.04	1.04	2.9	8.9	11.7	501	1920	2600	8.79	4.64	5.2	4.12	A+	
	22	07*	07*	05*	4.33	1.67	1.67	1.24	2.9	8.9	11.7	501	1920	2600	8.79	4.64	5.2	4.12	A+	
	24	07*	07*	05*	4.65	1.55	1.55	1.15	2.9	8.9	11.7	501	1920	2600	8.79	4.64	5.2	4.12	A+	
	22	10*	07*	05*	3.97	2.27	1.53	1.13	2.9	8.9	11.7	501	1920	2600	8.79	4.64	5.2	4.12	A+	
	24	10*	07*	05*	4.29	2.12	1.43	1.06	2.9	8.9	11.7	501	1920	2600	8.79	4.64	5.2	4.12	A+	
	22	13*	07*	05*	3.73	2.66	1.44	1.07	2.9	8.9	11.7	501	1920	2600	8.79	4.64	5.2	4.12	A+	
	24	13*	07*	05*	4.05	2.50	1.35	1.00	2.9	8.9	11.7	501	1920	2600	8.79	4.64	5.2	4.12	A+	
	22	10*	10*	05*	3.66	2.09	2.09	1.05	2.9	8.9	11.7	501	1920	2600	8.79	4.64	5.2	4.12	A+	
	24	10*	10*	05*	3.98	1.97	1.97	0.98	2.9	8.9	11.7	501	1920	2600	8.79	4.64	5.2	4.12	A+	
	22	13*	10*	05*	3.46	2.47	1.98	0.99	2.9	8.9	11.7	501	1920	2600	8.79	4.64	5.2	4.12	A+	
	24	13*	10*	05*	3.77	2.33	1.86	0.93	2.9	8.9	11.7	501	1920	2600	8.79	4.64	5.2	4.12	A+	
	22	07*	07*	07*	4.13	1.59	1.59	1.59	2.6	8.9	11.7	480	1905	2600	8.72	4.67	5.2	4.12	A+	
	24	07*	07*	07*	4.45	1.48	1.48	1.48	2.6	8.9	11.7	480	1905	2600	8.72	4.67	5.2	4.12	A+	
	22	10*	07*	07*	3.80	2.17	1.47	1.47	2.6	8.9	11.7	480	1905	2600	8.72	4.67	5.2	4.12	A+	
	24	10*	07*	07*	4.12	2.03	1.37	1.37	2.6	8.9	11.7	480	1905	2600	8.72	4.67	5.2	4.12	A+	
	22	13*	07*	07*	3.58	2.56	1.38	1.38	2.6	8.9	11.7	480	1905	2600	8.72	4.67	5.2	4.12	A+	
	24	13*	07*	07*	3.90	2.41	1.30	1.30	2.6	8.9	11.7	480	1905	2600	8.72	4.67	5.2	4.12	A+	
22	10*	10*	07*	3.52	2.01	2.01	1.36	2.6	8.9	11.7	480	1905	2600	8.72	4.67	5.2	4.12	A+		
24	10*	10*	07*	3.83	1.89	1.89	1.28	2.6	8.9	11.7	480	1905	2600	8.72	4.67	5.2	4.12	A+		
22	13*	10*	07*	3.37	2.41	1.93	1.30	2.6	9.0	11.7	480	1927	2600	8.82	4.67	5.2	4.12	A+		
24	13*	10*	07*	3.68	2.27	1.82	1.23	2.6	9.0	11.7	480	1927	2600	8.82	4.67	5.2	4.12	A+		
22	10*	10*	10*	3.32	1.89	1.89	1.89	2.6	9.0	11.7	480	1927	2600	8.82	4.67	5.2	4.12	A+		
24	10*	10*	10*	3.63	1.79	1.79	1.79	2.6	9.0	11.7	480	1927	2600	8.82	4.67	5.2	4.12	A+		

RAS-5M34U2AVG-E / TR - Performances in Cooling mode

Operating status	Combination				Unit capacity (kW)				Cooling capacity (kW)			Power input (W)			Operating current (A)		EER	Seasonal efficiencies*		
	Unit A	Unit B	Unit C	Unit D	Unit A	Unit B	Unit C	Unit D	Unit E	Min.	Nom.	Max.	Min.	Nom.	Max.	Min.		Nom.	PdC	SEER
1 unit operation	05	-	-	-	1.50	-	-	-	-	1.4	1.5	2.0	630	640	3.61	-	-	-	-	-
	07	-	-	-	2.00	-	-	-	-	1.4	2.0	2.5	640	650	3.67	-	-	-	-	-
	10	-	-	-	2.70	-	-	-	-	1.4	2.7	3.2	640	750	4.23	-	-	-	-	-
	13	-	-	-	3.70	-	-	-	-	1.4	3.7	4.4	640	1200	5.93	-	-	-	-	-
	16	-	-	-	4.50	-	-	-	-	1.4	4.5	5.0	640	1650	7.63	-	-	-	-	-
	18	-	-	-	5.00	-	-	-	-	1.4	5.0	5.2	640	1950	8.92	-	-	-	-	-
	22	-	-	-	6.00	-	-	-	-	2.4	6.0	6.8	660	2020	9.15	-	-	-	-	-
	24	-	-	-	7.10	-	-	-	-	2.4	7.1	7.2	660	2390	10.82	-	-	-	-	-
	05	05	-	-	1.50	1.50	-	-	-	2.5	3.0	4.0	640	1210	1480	5.54	2.48	3.0	4.82	B
	07	05	-	-	2.00	1.50	-	-	-	2.5	3.5	4.5	640	1310	1625	6.00	2.67	3.5	5.05	B
	10	05	-	-	2.70	1.50	-	-	-	2.5	4.2	5.2	640	1440	1810	6.59	2.92	4.2	5.32	A
	13	05	-	-	3.56	1.44	-	-	-	2.5	5.0	6.0	640	1620	1980	7.41	3.09	5.0	5.38	A
	16	05	-	-	4.35	1.45	-	-	-	2.5	5.8	6.5	640	1810	2160	8.28	3.20	5.8	5.55	A
	18	05	-	-	4.54	1.36	-	-	-	2.5	5.9	6.6	640	1810	2220	8.28	3.26	5.9	5.51	A
22	05	-	-	5.04	1.26	-	-	-	2.5	6.3	6.9	640	2040	2400	9.34	3.09	6.3	5.54	A	
24	05	-	-	5.20	1.10	-	-	-	2.5	6.3	6.9	640	2040	2400	9.34	3.09	6.3	5.31	A	
07	07	-	-	2.00	2.00	-	-	-	2.5	4.0	5.0	640	1400	1770	6.41	2.86	4.0	5.25	A	
10	07	-	-	2.70	2.00	-	-	-	2.5	4.7	5.7	640	1530	1910	7.00	3.07	4.7	5.48		

RAS-5M34U2AVG-E / TR - Performances in Cooling mode

Operating status	Combination					Unit capacity (kW)					Cooling capacity (kW)			Power input (W)			Operating current (A)		EER	Seasonal efficiencies*	
	Unit A	Unit B	Unit C	Unit D	Unit E	Unit A	Unit B	Unit C	Unit D	Unit E	Min.	Nom.	Max.	Min.	Nom.	Max.	Operating	Nom.	Nom.	Pdc	SEER
2 units operations	24	16	-	-	-	4.47	2.83	-	-	-	3.2	7.3	7.5	700	2550	2750	11.67	2.86	7.3	5.58	A
	18	18	-	-	-	3.60	3.60	-	-	-	3.2	7.2	7.5	700	2550	2750	11.67	2.82	7.2	5.52	A
	22	18	-	-	-	4.04	3.36	-	-	-	3.2	7.4	7.5	700	2550	2750	11.67	2.90	7.4	5.58	A
	24	18	-	-	-	4.34	3.06	-	-	-	3.2	7.4	7.5	700	2550	2750	11.67	2.90	7.4	5.58	A
	22	22	-	-	-	4.00	4.00	-	-	-	3.2	8.0	8.3	700	2570	2770	11.64	3.11	8.0	5.97	A+
	24	22	-	-	-	4.34	3.66	-	-	-	3.2	8.0	8.3	700	2570	2770	11.64	3.11	8.0	5.96	A+
	24	24	-	-	-	4.05	4.05	-	-	-	3.2	8.1	8.4	700	2600	2800	11.78	3.12	8.1	5.97	A+
3 units operations	05	05	05	-	-	1.50	1.50	1.50	-	-	3.8	4.5	5.5	950	1840	1910	8.42	2.45	4.5	5.44	A
	07	05	05	-	-	2.00	1.50	1.50	-	-	3.8	5.0	6.0	950	1930	2060	8.83	2.59	5.0	5.51	A
	10	05	05	-	-	2.70	1.50	1.50	-	-	3.8	5.7	6.5	950	2040	2210	9.34	2.79	5.7	5.72	A+
	13	05	05	-	-	3.59	1.46	1.46	-	-	3.8	6.5	7.2	950	2300	2410	10.53	2.83	6.5	5.80	A+
	16	05	05	-	-	4.32	1.44	1.44	-	-	3.8	7.2	8.2	950	2400	2660	10.98	3.00	7.2	5.92	A+
	18	05	05	-	-	4.75	1.43	1.43	-	-	3.8	7.6	8.3	950	2410	2690	11.03	3.15	7.6	5.97	A+
	22	05	05	-	-	5.13	1.28	1.28	-	-	3.8	7.7	8.5	950	2410	2720	11.03	3.20	7.7	6.00	A+
	24	05	05	-	-	5.27	1.11	1.11	-	-	3.8	7.5	8.5	950	2410	2720	11.03	3.11	7.5	5.95	A+
	07	07	05	-	-	2.00	2.00	1.50	-	-	3.8	5.5	6.3	950	2010	2170	9.20	2.74	5.5	5.66	A+
	10	07	05	-	-	2.70	2.00	1.50	-	-	3.8	6.2	6.9	950	2120	2330	9.70	2.92	6.2	5.77	A+
	13	07	05	-	-	3.55	1.92	1.44	-	-	3.8	6.9	7.8	950	2400	2230	10.98	2.88	6.9	5.88	A+
	16	07	05	-	-	4.28	1.90	1.43	-	-	3.8	7.6	8.3	950	2410	2690	11.03	3.15	7.6	6.00	A+
	18	07	05	-	-	4.53	1.81	1.36	-	-	3.8	7.7	8.5	950	2410	2720	11.03	3.20	7.7	5.99	A+
	22	07	05	-	-	4.86	1.62	1.22	-	-	3.8	7.7	8.5	950	2410	2720	11.03	3.20	7.7	6.00	A+
	24	07	05	-	-	5.22	1.47	1.10	-	-	3.8	7.8	8.6	950	2430	2760	11.12	3.21	7.8	6.02	A+
	10	10	05	-	-	2.70	2.70	1.50	-	-	3.8	6.9	7.8	950	2400	2230	10.98	2.88	6.9	5.88	A+
	13	10	05	-	-	3.56	2.60	1.44	-	-	3.8	7.6	8.3	950	2410	2690	11.03	3.15	7.6	6.00	A+
	16	10	05	-	-	3.98	2.39	1.33	-	-	3.8	7.7	8.5	950	2410	2720	11.03	3.20	7.7	6.02	A+
	18	10	05	-	-	4.18	2.26	1.26	-	-	3.8	7.7	8.5	950	2410	2720	11.03	3.20	7.7	5.99	A+
	22	10	05	-	-	4.59	2.06	1.15	-	-	3.8	7.8	8.6	950	2430	2760	11.12	3.21	7.8	6.02	A+
	24	10	05	-	-	4.90	1.86	1.04	-	-	3.8	7.8	8.6	950	2430	2760	11.12	3.21	7.8	6.02	A+
	13	13	05	-	-	3.20	3.20	1.30	-	-	3.8	7.7	8.5	950	2410	2720	11.03	3.20	7.7	6.02	A+
	16	13	05	-	-	3.48	2.86	1.16	-	-	3.8	7.5	8.5	950	2410	2720	11.03	3.11	7.5	5.98	A+
	18	13	05	-	-	3.82	2.83	1.15	-	-	3.8	7.8	8.6	950	2430	2760	11.12	3.21	7.8	6.00	A+
	22	13	05	-	-	4.18	2.58	1.04	-	-	3.8	7.8	8.6	950	2430	2760	11.12	3.21	7.8	6.02	A+
	24	13	05	-	-	4.50	2.35	0.95	-	-	3.8	7.8	8.6	950	2430	2760	11.12	3.21	7.8	6.02	A+
	16	16	05	-	-	3.34	3.34	1.11	-	-	3.8	7.8	8.6	950	2430	2760	11.12	3.21	7.8	6.02	A+
	18	16	05	-	-	3.55	3.19	1.06	-	-	3.8	7.8	8.6	950	2430	2760	11.12	3.21	7.8	6.00	A+
	22	16	05	-	-	3.95	2.96	0.99	-	-	3.8	7.9	8.7	950	2440	2780	11.17	3.24	7.9	6.04	A+
	24	16	05	-	-	4.28	2.71	0.90	-	-	3.8	7.9	8.7	950	2440	2780	11.17	3.24	7.9	6.04	A+
	18	18	05	-	-	3.39	3.39	1.02	-	-	3.8	7.8	8.6	950	2430	2760	11.12	3.21	7.8	5.97	A+
	22	18	05	-	-	3.79	3.16	0.95	-	-	3.8	7.9	8.7	950	2440	2780	11.17	3.24	7.9	6.02	A+
	24	18	05	-	-	4.12	2.90	0.87	-	-	3.8	7.9	8.7	950	2440	2780	11.17	3.24	7.9	6.01	A+
	22	22	05	-	-	3.51	3.51	0.88	-	-	3.8	7.9	8.7	950	2440	2780	11.17	3.24	7.9	6.04	A+
	24	22	05	-	-	3.89	3.29	0.82	-	-	3.8	8.0	8.8	950	2450	2810	11.21	3.27	8.0	6.12	A++
	24	24	05	-	-	3.62	3.62	0.76	-	-	3.8	8.0	8.9	950	2450	2830	11.21	3.27	8.0	6.12	A++
	07	07	07	-	-	2.00	2.00	2.00	-	-	3.8	6.0	7.5	950	2100	2500	9.61	2.86	6.0	5.72	A+
	10	07	07	-	-	2.70	2.00	2.00	-	-	3.8	6.7	8.2	950	2400	2660	10.98	2.79	6.7	5.83	A+
	13	07	07	-	-	3.65	1.97	1.97	-	-	3.9	7.6	8.3	950	2410	2690	11.03	3.15	7.6	5.84	A+
	16	07	07	-	-	4.08	1.81	1.81	-	-	4.0	7.7	8.5	960	2410	2720	11.03	3.20	7.7	5.83	A+
	18	07	07	-	-	4.28	1.71	1.71	-	-	4.0	7.7	8.5	960	2410	2720	11.03	3.20	7.7	5.81	A+
	22	07	07	-	-	4.68	1.56	1.56	-	-	4.1	7.8	8.6	970	2430	2760	11.12	3.21	7.8	6.04	A+
	24	07	07	-	-	4.99	1.41	1.41	-	-	4.1	7.8	8.6	970	2430	2760	11.12	3.21	7.8	6.03	A+
	10	10	07	-	-	2.70	2.70	2.00	-	-	3.8	7.4	8.2	950	2400	2660	10.98	3.08	7.4	5.62	A+
	13	10	07	-	-	3.39	2.48	1.83	-	-	3.9	7.7	8.3	960	2410	2690	11.03	3.20	7.7	5.83	A+
	16	10	07	-	-	3.77	2.26	1.67	-	-	4.0	7.7	8.5	960	2410	2720	11.03	3.20	7.7	5.83	A+
	18	10	07	-	-	3.97	2.14	1.59	-	-	4.0	7.7	8.5	960	2410	2720	11.03	3.20	7.7	5.81	A+
	22	10	07	-	-	4.37	1.97	1.46	-	-	4.1	7.8	8.6	970	2430	2760	11.12	3.21	7.8	6.04	A+
	24	10	07	-	-	4.69	1.78	1.32	-	-	4.1	7.8	8.6	970	2430	2760	11.12	3.21	7.8	6.03	A+
	13	13	07	-	-	3.03	3.03	1.63	-	-	4.0	7.7	8.5	960	2410	2720	11.03	3.20	7.7	5.83	A+
	16	13	07	-	-	3.44	2.83	1.54	-	-	4.1	7.8	8.6	970	2430	2760	11.12	3.21	7.8	5.83	A+
	18	13	07	-	-	3.64	2.70	1.46	-	-	4.1	7.8	8.6	970	2430	2760	11.12	3.21	7.8	5.80	A+
22	13	07	-	-	4.00	2.47	1.33	-	-	4.1	7.8	8.6	970	2430	2760	11.12	3.21	7.8	6.04	A+	
24	13	07	-	-	4.38	2.28	1.23	-	-	4.1	7.9	8.7	970	2440	2780	11.17	3.24	7.9	6.04	A+	
16	16	07	-	-	3.19	3.19	1.42	-	-	4.1	7.8	8.6	970	2430	2760	11.12	3.21	7.8	5.94	A+	
18	16	07	-	-	3.39	3.05	1.36	-	-	4.1	7.8	8.6	970	2430	2760	11.12	3.21	7.8	6.01	A+	
22	16	07	-	-	3.79	2.84	1.26	-	-	4.1	7.9	8.7	970	2440	2780	11.17	3.24	7.9	6.04	A+	
24	16	07	-	-	4.12	2.61	1.16	-	-	4.1	7.9	8.7	970	2440	2780	11.17	3.24	7.9	6.04	A+	
18	18	07	-	-	3.29	3.29	1.32	-	-	4.1	7.9	8.7	970	2440	2780	11.17	3.24	7.9	5.99	A+	
22	18	07	-	-	3.65	3.04	1.22	-	-	4.1	7.9	8.7	970	2440	2780	11.17	3.24	7.9	6.02	A+	
24	18	07	-	-	3.98	2.80	1.12	-	-	4.1	7.9	8.7	970	2440	2780	11.17	3.24	7.9	6.01	A+	
22	22	07	-	-	3.43	3.43	1.14	-	-	4.1	8.0	8.8	970	2440	2810	11.17	3.28	8.0	6.13	A++	
24	22	07	-	-	3.81	3.22	1.07	-	-	4.1	8.1	8.9	970	2440	2830	11.17	3.32	8.1	6.05	A+	
24	2																				



RAS-5M34U2AVG-E / TR - Performances in Cooling mode

Operating status	Combination					Unit capacity (kW)					Cooling capacity (kW)			Power input (W)			Operating current (A)	EER		Seasonal efficiencies*		
	Unit A	Unit B	Unit C	Unit D	Unit E	Unit A	Unit B	Unit C	Unit D	Unit E	Min.	Nom.	Max.	Min.	Nom.	Max.	Nom.	Nom.	Pdc	SEER	Class	
3 units operations	24	16	13	-	-	3.71	2.35	1.93	-	-	4.3	8.0	9.0	980	2450	2900	11.21	3.27	8.0	6.06	A+	
	18	18	13	-	-	2.88	2.88	2.13	-	-	4.1	7.9	8.7	970	2440	2830	11.17	3.24	7.9	5.99	A+	
	22	18	13	-	-	3.31	2.76	2.04	-	-	4.1	8.1	9.0	970	2440	2900	11.17	3.32	8.1	6.04	A+	
	24	18	13	-	-	3.64	2.56	1.90	-	-	4.1	8.1	9.0	970	2440	2900	11.17	3.32	8.1	6.04	A+	
	16	16	16	-	-	2.67	2.67	2.67	-	-	4.3	8.0	9.0	980	2450	2900	11.21	3.27	8.0	6.06	A+	
4 units operations	05	05	05	05	-	1.50	1.50	1.50	1.50	-	4.0	6.0	7.0	930	1840	2270	8.42	3.26	6.0	5.71	A+	
	07	05	05	05	-	2.00	1.50	1.50	1.50	-	4.0	6.5	7.4	930	2020	2400	9.24	3.22	6.5	5.81	A+	
	10	05	05	05	-	2.70	1.50	1.50	1.50	-	4.0	7.2	8.0	930	2250	2580	10.30	3.20	7.2	5.89	A+	
	13	05	05	05	-	3.61	1.46	1.46	1.46	-	4.0	8.0	8.7	930	2500	2800	11.44	3.20	8.0	5.96	A+	
	16	05	05	05	-	4.20	1.40	1.40	1.40	-	4.0	8.4	8.8	930	2710	2820	12.40	3.10	8.4	6.00	A+	
	18	05	05	05	-	4.47	1.34	1.34	1.34	-	4.0	8.5	8.9	930	2720	2840	12.45	3.13	8.5	6.00	A+	
	22	05	05	05	-	4.97	1.24	1.24	1.24	-	4.0	8.7	9.1	930	2720	2850	12.45	3.20	8.7	6.06	A+	
	24	05	05	05	-	5.39	1.14	1.14	1.14	-	4.0	8.8	9.2	930	2730	2880	12.49	3.22	8.8	6.07	A+	
	07	07	05	05	-	2.00	2.00	1.50	1.50	-	4.0	7.0	7.9	930	2200	2540	10.07	3.18	7.0	5.85	A+	
	10	07	05	05	-	2.74	2.03	1.52	1.52	-	4.0	7.8	8.5	930	2460	2730	11.26	3.17	7.8	5.94	A+	
	13	07	05	05	-	3.53	1.91	1.43	1.43	-	4.0	8.3	8.8	930	2660	2810	12.17	3.12	8.3	5.99	A+	
	16	07	05	05	-	4.03	1.79	1.34	1.34	-	4.0	8.5	8.9	930	2720	2840	12.45	3.13	8.5	6.02	A+	
	18	07	05	05	-	4.30	1.72	1.29	1.29	-	4.0	8.6	9.0	930	2720	2850	12.45	3.16	8.6	6.02	A+	
	22	07	05	05	-	4.80	1.60	1.20	1.20	-	4.0	8.8	9.2	930	2730	2880	12.49	3.22	8.8	6.08	A+	
	24	07	05	05	-	5.22	1.47	1.10	1.10	-	4.0	8.9	9.3	930	2730	2880	12.49	3.26	8.9	6.09	A+	
	10	10	05	05	-	2.67	2.67	1.48	1.48	-	4.0	8.3	8.8	930	2660	2810	12.17	3.12	8.3	5.99	A+	
	13	10	05	05	-	3.35	2.44	1.36	1.36	-	4.0	8.5	8.9	930	2720	2840	12.45	3.13	8.5	6.02	A+	
	16	10	05	05	-	3.84	2.30	1.28	1.28	-	4.0	8.7	9.1	930	2720	2850	12.45	3.20	8.7	6.06	A+	
	18	10	05	05	-	4.11	2.22	1.23	1.23	-	4.0	8.8	9.2	930	2730	2870	12.49	3.22	8.8	6.06	A+	
	22	10	05	05	-	4.56	2.05	1.14	1.14	-	4.0	8.9	9.3	930	2730	2880	12.49	3.26	8.9	6.10	A++	
	24	10	05	05	-	4.99	1.90	1.05	1.05	-	4.0	9.0	9.4	930	2740	2900	12.54	3.28	9.0	6.11	A++	
	13	13	05	05	-	3.10	3.10	1.25	1.25	-	4.0	8.7	9.1	930	2720	2850	12.45	3.20	8.7	6.06	A+	
	16	13	05	05	-	3.54	2.91	1.18	1.18	-	4.0	8.8	9.2	930	2730	2880	12.49	3.22	8.8	6.08	A+	
	18	13	05	05	-	3.80	2.81	1.14	1.14	-	4.0	8.9	9.3	930	2730	2880	12.49	3.26	8.9	6.07	A+	
	22	13	05	05	-	4.25	2.62	1.06	1.06	-	4.0	9.0	9.4	930	2740	2900	12.54	3.28	9.0	6.11	A++	
	24	13	05	05	-	4.63	2.41	0.98	0.98	-	4.0	9.0	9.4	930	2740	2900	12.54	3.28	9.0	6.11	A++	
	16	16	05	05	-	3.34	3.34	1.11	1.11	-	4.0	8.9	9.3	930	2730	2880	12.49	3.26	8.9	6.10	A++	
	18	16	05	05	-	3.60	3.24	1.08	1.08	-	4.0	9.0	9.4	930	2740	2900	12.54	3.28	9.0	6.09	A+	
	22	16	05	05	-	4.00	3.00	1.00	1.00	-	4.0	9.0	9.4	930	2740	2900	12.54	3.28	9.0	6.11	A++	
	24	16	05	05	-	4.38	2.77	0.92	0.92	-	4.0	9.0	9.4	930	2740	2900	12.54	3.28	9.0	6.11	A++	
	18	18	05	05	-	3.46	3.46	1.04	1.04	-	4.0	9.0	9.4	930	2740	2900	12.54	3.28	9.0	6.07	A+	
	22	18	05	05	-	3.86	3.21	0.96	0.96	-	4.0	9.0	9.4	930	2740	2900	12.54	3.28	9.0	6.09	A+	
	24	18	05	05	-	4.23	2.98	0.89	0.89	-	4.0	9.0	9.4	930	2740	2900	12.54	3.28	9.0	6.09	A+	
	22	22	05	05	-	3.60	3.60	0.90	0.90	-	4.0	9.0	9.4	930	2740	2900	12.54	3.28	9.0	6.11	A++	
	07	07	07	05	-	2.00	2.00	2.00	1.50	-	4.0	7.5	8.3	930	2370	2670	10.85	3.16	7.5	5.89	A+	
	10	07	07	05	-	2.67	1.98	1.98	1.48	-	4.0	8.1	8.7	930	2600	2810	11.90	3.12	8.1	5.96	A+	
	13	07	07	05	-	3.42	1.85	1.85	1.39	-	4.0	8.5	8.9	930	2710	2830	12.40	3.14	8.5	6.02	A+	
	16	07	07	05	-	3.87	1.72	1.72	1.29	-	4.0	8.6	9.0	930	2720	2850	12.45	3.16	8.6	6.04	A+	
	18	07	07	05	-	4.14	1.66	1.66	1.24	-	4.0	8.7	9.1	930	2720	2850	12.45	3.20	8.7	6.04	A+	
	22	07	07	05	-	4.64	1.55	1.55	1.16	-	4.0	8.9	9.3	930	2730	2880	12.49	3.26	8.9	6.10	A++	
	24	07	07	05	-	5.07	1.43	1.43	1.07	-	4.0	9.0	9.4	930	2740	2900	12.54	3.28	9.0	6.11	A++	
	10	10	07	05	-	2.58	2.58	1.91	1.43	-	4.0	8.5	8.9	930	2710	2830	12.40	3.14	8.5	6.02	A+	
	13	10	07	05	-	3.21	2.35	1.74	1.30	-	4.0	8.6	9.0	930	2720	2850	12.45	3.16	8.6	6.04	A+	
	16	10	07	05	-	3.70	2.22	1.64	1.23	-	4.0	8.8	9.2	930	2730	2870	12.49	3.22	8.8	6.08	A+	
18	10	07	05	-	3.93	2.12	1.57	1.18	-	4.0	8.8	9.2	930	2730	2880	12.49	3.22	8.8	6.06	A+		
22	10	07	05	-	4.43	1.99	1.48	1.11	-	4.0	9.0	9.4	930	2740	2900	12.54	3.28	9.0	6.11	A++		
24	10	07	05	-	4.80	1.83	1.35	1.02	-	4.0	9.0	9.4	930	2740	2900	12.54	3.28	9.0	6.11	A++		
13	13	07	05	-	2.99	2.99	1.61	1.21	-	4.0	8.8	9.2	930	2730	2870	12.49	3.22	8.8	6.08	A+		
16	13	07	05	-	3.42	2.81	1.52	1.14	-	4.0	8.9	9.3	930	2730	2880	12.49	3.26	8.9	6.10	A++		
18	13	07	05	-	3.69	2.73	1.48	1.11	-	4.0	9.0	9.4	930	2740	2900	12.54	3.28	9.0	6.09	A+		
22	13	07	05	-	4.09	2.52	1.36	1.02	-	4.0	9.0	9.4	930	2740	2900	12.54	3.28	9.0	6.11	A++		
24	13	07	05	-	4.47	2.33	1.26	0.94	-	4.0	9.0	9.4	930	2740	2900	12.54	3.28	9.0	6.11	A++		
16	16	07	05	-	3.24	3.24	1.44	1.08	-	4.0	9.0	9.4	930	2740	2900	12.54	3.28	9.0	6.12	A++		
18	16	07	05	-	3.46	3.12	1.38	1.04	-	4.0	9.0	9.4	930	2740	2900	12.54	3.28	9.0	6.09	A+		
22	16	07	05	-	3.86	2.89	1.29	0.96	-	4.0	9.0	9.4	930	2740	2900	12.54	3.28	9.0	6.11	A++		
18	18	07	05	-	3.33	3.33	1.33	1.00	-	4.0	9.0	9.4	930	2740	2900	12.54	3.28	9.0	6.07	A+		
22	18	07	05	-	3.72	3.10	1.24	0.93	-	4.0	9.0	9.4	930	2740	2900	12.54	3.28	9.0	6.09	A+		
10	10	10	05	-	2.42	2.42	2.42	1.34	-	4.0	8.6	9.0	930	2720	2850	12.45	3.16	8.6	6.04	A+		
13	10	10	05	-	3.07	2.24	2.24	1.25	-	4.0	8.8	9.2	930	2730	2870	12.49	3.22	8.8	6.08	A+		
16	10	10	05	-	3.51	2.11	2.11	1.17	-	4.0	8.9	9.3	930	2730	2880	12.49	3.26	8.9	6.10	A++		
18	10	10	05	-	3.78	2.04	2.04	1.13	-	4.0	9.0	9.4	930	2740	2900	12.54	3.28	9.0	6.09	A+		
22	10	10	05	-	4.19	1.88	1.88	1.05	-	4.0	9.0	9.4	930	2740	2900	12.54	3.28	9.0	6.11	A++		
24	10	10	05	-	4.56	1.74	1.74	0.96	-	4.0	9.0	9.4	930	2740	2900	12.54	3.28	9.0	6.11	A++		
13	13	10	05	-	2.84	2.84	2.07	1.15	-	4.0	8.9	9.3	930	2730	2880	12.						

RAS-5M34U2AVG-E / TR - Performances in Cooling mode

Operating status	Combination					Unit capacity (kW)					Cooling capacity (kW)			Power input (W)			Operating current (A)	EER	Seasonal efficiencies*		
	Unit A	Unit B	Unit C	Unit D	Unit E	Unit A	Unit B	Unit C	Unit D	Unit E	Min.	Nom.	Max.	Min.	Nom.	Max.	Nom.	Nom.	Pdc	SEER	Class
4 units operations	22	16	07	07	-	3.72	2.79	1.24	1.24	-	4.2	9.0	9.4	950	2740	2900	12.54	3.28	9.0	6.11	A++
	24	16	07	07	-	4.10	2.60	1.15	1.15	-	4.2	9.0	9.4	950	2740	2900	12.54	3.28	9.0	6.11	A++
	18	18	07	07	-	3.21	3.21	1.29	1.29	-	4.2	9.0	9.4	950	2740	2900	12.54	3.28	9.0	6.07	A+
	22	18	07	07	-	3.60	3.00	1.20	1.20	-	4.2	9.0	9.4	950	2740	2900	12.54	3.28	9.0	6.09	A+
	24	18	07	07	-	3.97	2.80	1.12	1.12	-	4.2	9.0	9.4	950	2740	2900	12.54	3.28	9.0	6.09	A+
	10	10	10	07	-	2.30	2.30	2.30	1.70	-	4.1	8.6	9.0	940	2720	2850	12.45	3.16	8.6	6.04	A+
	13	10	10	07	-	2.93	2.14	2.14	1.59	-	4.1	8.8	9.2	940	2730	2880	12.49	3.22	8.8	6.08	A+
	16	10	10	07	-	3.37	2.02	2.02	1.50	-	4.1	8.9	9.3	940	2730	2880	12.49	3.26	8.9	6.10	A++
	18	10	10	07	-	3.63	1.96	1.96	1.45	-	4.2	9.0	9.4	950	2740	2900	12.54	3.28	9.0	6.09	A+
	22	10	10	07	-	4.03	1.81	1.81	1.34	-	4.2	9.0	9.4	950	2740	2900	12.54	3.28	9.0	6.11	A++
	24	10	10	07	-	4.41	1.68	1.68	1.24	-	4.2	9.0	9.4	950	2740	2900	12.54	3.28	9.0	6.11	A++
	13	13	10	07	-	2.75	2.75	2.01	1.49	-	4.2	9.0	9.4	950	2740	2900	12.54	3.28	9.0	6.12	A++
	16	13	10	07	-	3.14	2.58	1.88	1.40	-	4.2	9.0	9.4	950	2740	2900	12.54	3.28	9.0	6.12	A++
	18	13	10	07	-	3.36	2.49	1.81	1.34	-	4.2	9.0	9.4	950	2740	2900	12.54	3.28	9.0	6.09	A+
	22	13	10	07	-	3.75	2.31	1.69	1.25	-	4.2	9.0	9.4	950	2740	2900	12.54	3.28	9.0	6.11	A++
	24	13	10	07	-	4.12	2.15	1.57	1.16	-	4.2	9.0	9.4	950	2740	2900	12.54	3.28	9.0	6.11	A++
	16	16	10	07	-	2.96	2.96	1.77	1.31	-	4.2	9.0	9.4	950	2740	2900	12.54	3.28	9.0	6.12	A++
	18	16	10	07	-	3.17	2.85	1.71	1.27	-	4.2	9.0	9.4	950	2740	2900	12.54	3.28	9.0	6.09	A+
	22	16	10	07	-	3.55	2.66	1.60	1.18	-	4.2	9.0	9.4	950	2740	2900	12.54	3.28	9.0	6.11	A++
	24	16	10	07	-	3.92	2.48	1.49	1.10	-	4.2	9.0	9.4	950	2740	2900	12.54	3.28	9.0	6.11	A++
	18	18	10	07	-	3.06	3.06	1.65	1.22	-	4.2	9.0	9.4	950	2740	2900	12.54	3.28	9.0	6.07	A+
	22	18	10	07	-	3.44	2.87	1.55	1.15	-	4.2	9.0	9.4	950	2740	2900	12.54	3.28	9.0	6.09	A+
	24	18	10	07	-	3.80	2.68	1.45	1.07	-	4.2	9.0	9.4	950	2740	2900	12.54	3.28	9.0	6.09	A+
	13	13	13	07	-	2.54	2.54	2.54	1.37	-	4.2	9.0	9.4	950	2740	2900	12.54	3.28	9.0	6.12	A++
	16	13	13	07	-	2.91	2.40	2.40	1.29	-	4.2	9.0	9.4	950	2740	2900	12.54	3.28	9.0	6.12	A++
	18	13	13	07	-	3.13	2.31	2.31	1.25	-	4.2	9.0	9.4	950	2740	2900	12.54	3.28	9.0	6.09	A+
	22	13	13	07	-	3.51	2.16	2.16	1.17	-	4.2	9.0	9.4	950	2740	2900	12.54	3.28	9.0	6.11	A++
	24	13	13	07	-	3.87	2.02	2.02	1.09	-	4.2	9.0	9.4	950	2740	2900	12.54	3.28	9.0	6.11	A++
	16	16	13	07	-	2.76	2.76	2.27	1.22	-	4.2	9.0	9.4	950	2740	2900	12.54	3.28	9.0	6.12	A++
	18	16	13	07	-	2.96	2.66	2.19	1.18	-	4.2	9.0	9.4	950	2740	2900	12.54	3.28	9.0	6.09	A+
	22	16	13	07	-	3.33	2.50	2.06	1.11	-	4.2	9.0	9.4	950	2740	2900	12.54	3.28	9.0	6.11	A++
	24	16	13	07	-	3.69	2.34	1.92	1.04	-	4.2	9.0	9.4	950	2740	2900	12.54	3.28	9.0	6.11	A++
	18	18	13	07	-	2.87	2.87	2.12	1.15	-	4.2	9.0	9.4	950	2740	2900	12.54	3.28	9.0	6.07	A+
	22	18	13	07	-	3.23	2.69	1.99	1.08	-	4.2	9.0	9.4	950	2740	2900	12.54	3.28	9.0	6.09	A+
	24	18	13	07	-	3.59	2.53	1.87	1.01	-	4.2	9.0	9.4	950	2740	2900	12.54	3.28	9.0	6.09	A+
	10	10	10	10	-	2.18	2.18	2.18	2.18	-	4.1	8.7	9.1	940	2720	2850	12.45	3.20	8.7	6.06	A+
	13	10	10	10	-	2.79	2.04	2.04	2.04	-	4.1	8.9	9.3	940	2730	2880	12.49	3.26	8.9	6.10	A++
	16	10	10	10	-	3.21	1.93	1.93	1.93	-	4.2	9.0	9.4	950	2740	2900	12.54	3.28	9.0	6.12	A++
	18	10	10	10	-	3.44	1.85	1.85	1.85	-	4.2	9.0	9.4	950	2740	2900	12.54	3.28	9.0	6.09	A+
	22	10	10	10	-	3.83	1.72	1.72	1.72	-	4.2	9.0	9.4	950	2740	2900	12.54	3.28	9.0	6.11	A++
	24	10	10	10	-	4.20	1.60	1.60	1.60	-	4.2	9.0	9.4	950	2740	2900	12.54	3.28	9.0	6.11	A++
	13	13	10	10	-	2.60	2.60	1.90	1.90	-	4.2	9.0	9.4	950	2740	2900	12.54	3.28	9.0	6.12	A++
	16	13	10	10	-	2.98	2.45	1.79	1.79	-	4.2	9.0	9.4	950	2740	2900	12.54	3.28	9.0	6.12	A++
	18	13	10	10	-	3.19	2.36	1.72	1.72	-	4.2	9.0	9.4	950	2740	2900	12.54	3.28	9.0	6.09	A+
	22	13	10	10	-	3.58	2.21	1.61	1.61	-	4.2	9.0	9.4	950	2740	2900	12.54	3.28	9.0	6.11	A++
	24	13	10	10	-	3.94	2.06	1.50	1.50	-	4.2	9.0	9.4	950	2740	2900	12.54	3.28	9.0	6.11	A++
	16	16	10	10	-	2.81	2.81	1.69	1.69	-	4.2	9.0	9.4	950	2740	2900	12.54	3.28	9.0	6.12	A++
	18	16	10	10	-	3.02	2.72	1.63	1.63	-	4.2	9.0	9.4	950	2740	2900	12.54	3.28	9.0	6.09	A+
22	16	10	10	-	3.40	2.55	1.53	1.53	-	4.2	9.0	9.4	950	2740	2900	12.54	3.28	9.0	6.11	A++	
24	16	10	10	-	3.76	2.38	1.43	1.43	-	4.2	9.0	9.4	950	2740	2900	12.54	3.28	9.0	6.11	A++	
18	18	10	10	-	2.92	2.92	1.58	1.58	-	4.2	9.0	9.4	950	2740	2900	12.54	3.28	9.0	6.07	A+	
22	18	10	10	-	3.29	2.74	1.48	1.48	-	4.2	9.0	9.4	950	2740	2900	12.54	3.28	9.0	6.09	A+	
24	18	10	10	-	3.65	2.57	1.39	1.39	-	4.2	9.0	9.4	950	2740	2900	12.54	3.28	9.0	6.09	A+	
13	13	13	10	-	2.41	2.41	2.41	1.76	-	4.2	9.0	9.4	950	2740	2900	12.54	3.28	9.0	6.12	A++	
16	13	13	10	-	2.77	2.28	2.28	1.66	-	4.2	9.0	9.4	950	2740	2900	12.54	3.28	9.0	6.12	A++	
18	13	13	10	-	2.98	2.21	2.21	1.61	-	4.2	9.0	9.4	950	2740	2900	12.54	3.28	9.0	6.09	A+	
22	13	13	10	-	3.35	2.07	2.07	1.51	-	4.2	9.0	9.4	950	2740	2900	12.54	3.28	9.0	6.11	A++	
24	13	13	10	-	3.72	1.94	1.94	1.41	-	4.2	9.0	9.4	950	2740	2900	12.54	3.28	9.0	6.11	A++	
16	16	13	10	-	2.63	2.63	2.16	1.58	-	4.2	9.0	9.4	950	2740	2900	12.54	3.28	9.0	6.12	A++	
18	16	13	10	-	2.83	2.55	2.09	1.53	-	4.2	9.0	9.4	950	2740	2900	12.54	3.28	9.0	6.09	A+	
22	16	13	10	-	3.20	2.40	1.97	1.44	-	4.2	9.0	9.4	950	2740	2900	12.54	3.28	9.0	6.11	A++	
24	16	13	10	-	3.55	2.25	1.85	1.35	-	4.2	9.0	9.4	950	2740	2900	12.54	3.28	9.0	6.11	A++	
18	18	13	10	-	2.74	2.74	2.03	1.48	-	4.2	9.0	9.4	950	2740	2900	12.54	3.28	9.0	6.07	A+	
22	18	13	10	-	3.10	2.59	1.91	1.40	-	4.2	9.0	9.4	950	2740	2900	12.54	3.28	9.0	6.09	A+	
24	18	13	10	-	3.45	2.43	1.80	1.31	-	4.2	9.0	9.4	950	2740	2900	12.54	3.28	9.0	6.09	A+	
13	13	13	13	-	2.25	2.25	2.25	2.25	-	4.2	9.0	9.4	950	2740	2900	12.54	3.28	9.0	6.12	A++	
16	13	13	13	-	2.60	2.13	2.13	2.13	-	4.2	9.0	9.4	950	2740	2900	12.54	3.28	9.0	6.12	A++	
18	13	13	13	-	2.80	2.07	2.07	2.07	-	4.2	9.0	9.4	950	2740	2900	12.54	3.28	9.0	6.09	A+	
22	13	13	13	-	3.16	1.95	1.95	1.95	-	4.2	9.0	9.4	950	2740	2900	12.54	3.28	9.0	6.11	A++	
24	13	13	13	-	3.51	1.83	1.83	1.83	-	4.2	9.0	9.4	950	2740	2900	12.54	3.28	9.0	6.11	A++	
16	16	13																			



RAS-5M34U2AVG-E / TR - Performances in Cooling mode

Operating status	Combination					Unit capacity (kW)					Cooling capacity (kW)			Power input (W)			Operating current (A)	EER	Seasonal efficiencies*			
	Unit A	Unit B	Unit C	Unit D	Unit E	Unit A	Unit B	Unit C	Unit D	Unit E	Min.	Nom.	Max.	Min.	Nom.	Max.	Nom.	Nom.	Pdc	SEER	Class	
Cooling, 230 V	5 units operations	10	07	07	05	05	2.70	2.00	2.00	1.50	1.50	3.7	9.7	10.7	950	2850	3380	13.04	3.40	9.7	6.35	A++
		13	07	07	05	05	3.42	1.85	1.85	1.39	1.39	3.7	9.9	11.0	950	2946	3670	13.48	3.36	9.9	6.29	A++
		16	07	07	05	05	3.87	1.72	1.72	1.29	1.29	3.7	9.9	11.0	950	2946	3670	13.48	3.36	9.9	6.29	A++
		18	07	07	05	05	4.13	1.65	1.65	1.24	1.24	3.7	9.9	11.0	950	2946	3670	13.48	3.36	9.9	6.27	A++
		10	10	07	05	05	2.57	2.57	1.90	1.43	1.43	3.7	9.9	11.0	950	2946	2800	13.48	3.36	9.9	6.29	A++
		13	10	07	05	05	3.21	2.34	1.74	1.30	1.30	3.7	9.9	11.0	950	2946	3670	13.48	3.36	9.9	6.29	A++
		16	10	07	05	05	3.65	2.19	1.62	1.22	1.22	3.7	9.9	11.0	950	2946	3670	13.48	3.36	9.9	6.29	A++
		18	10	07	05	05	3.90	2.10	1.56	1.17	1.17	3.7	9.9	11.0	950	2946	3670	13.48	3.36	9.9	6.27	A++
		13	13	07	05	05	2.95	2.95	1.60	1.20	1.20	3.7	9.9	11.0	950	2946	3670	13.48	3.36	9.9	6.29	A++
		16	13	07	05	05	3.38	2.78	1.50	1.13	1.13	3.7	9.9	11.0	950	2946	3670	13.48	3.36	9.9	6.29	A++
		18	13	07	05	05	3.61	2.67	1.45	1.08	1.08	3.7	9.9	11.0	950	2946	3670	13.48	3.36	9.9	6.27	A++
		16	16	07	05	05	3.18	3.18	1.41	1.06	1.06	3.7	9.9	11.0	950	2946	3670	13.48	3.36	9.9	6.29	A++
		18	16	07	05	05	3.41	3.07	1.37	1.02	1.02	3.7	9.9	11.0	950	2946	3670	13.48	3.36	9.9	6.27	A++
		10	10	10	05	05	2.41	2.41	2.41	1.34	1.34	3.7	9.9	11.0	950	2946	3670	13.48	3.36	9.9	6.29	A++
		13	10	10	05	05	3.03	2.21	2.21	1.23	1.23	3.7	9.9	11.0	950	2946	3670	13.48	3.36	9.9	6.29	A++
		16	10	10	05	05	3.45	2.07	2.07	1.15	1.15	3.7	9.9	11.0	950	2946	3670	13.48	3.36	9.9	6.29	A++
		18	10	10	05	05	3.69	1.99	1.99	1.11	1.11	3.7	9.9	11.0	950	2946	3670	13.48	3.36	9.9	6.27	A++
		13	13	10	05	05	2.80	2.80	2.04	1.13	1.13	3.7	9.9	11.0	950	2946	3670	13.48	3.36	9.9	6.29	A++
		07	07	07	07	05	2.00	2.00	2.00	2.00	1.50	3.7	9.5	10.5	950	2800	3300	12.81	3.39	9.5	6.32	A++
		10	07	07	07	05	2.62	1.94	1.94	1.46	1.46	3.7	9.9	11.0	950	2946	3670	13.48	3.36	9.9	6.29	A++
		13	07	07	07	05	3.27	1.77	1.77	1.33	1.33	3.7	9.9	11.0	950	2946	3670	13.48	3.36	9.9	6.29	A++
		16	07	07	07	05	3.71	1.65	1.65	1.24	1.24	3.7	9.9	11.0	950	2946	3670	13.48	3.36	9.9	6.29	A++
		18	07	07	07	05	3.96	1.58	1.58	1.19	1.19	3.7	9.9	11.0	950	2946	3670	13.48	3.36	9.9	6.27	A++
		10	10	07	07	05	2.45	2.45	1.82	1.36	1.36	3.7	9.9	11.0	950	2946	3670	13.48	3.36	9.9	6.29	A++
13	10	07	07	05	3.08	2.25	1.66	1.25	1.25	3.7	9.9	11.0	950	2946	3670	13.48	3.36	9.9	6.29	A++		
16	10	07	07	05	3.51	2.10	1.56	1.17	1.17	3.7	9.9	11.0	950	2946	3670	13.48	3.36	9.9	6.29	A++		
18	10	07	07	05	3.75	2.03	1.50	1.13	1.13	3.7	9.9	11.0	950	2946	3670	13.48	3.36	9.9	6.27	A++		
13	13	07	07	05	2.84	2.84	1.53	1.15	1.15	3.7	9.9	11.0	950	2946	3670	13.48	3.36	9.9	6.29	A++		
16	13	07	07	05	3.25	2.67	1.45	1.08	1.08	3.7	9.9	11.0	950	2946	3670	13.48	3.36	9.9	6.29	A++		
10	10	10	07	05	2.30	2.30	2.30	1.71	1.28	3.7	9.9	11.0	950	2946	3670	13.48	3.36	9.9	6.29	A++		
13	10	10	07	05	2.91	2.12	2.12	1.57	1.18	3.7	9.9	11.0	950	2946	3670	13.48	3.36	9.9	6.29	A++		
16	10	10	07	05	3.32	1.99	1.99	1.48	1.11	3.7	9.9	11.0	950	2946	3670	13.48	3.36	9.9	6.29	A++		
10	10	10	10	05	2.17	2.17	2.17	2.17	1.21	3.7	9.9	11.0	950	2946	3670	13.48	3.36	9.9	6.29	A++		
07	07	07	07	07	1.96	1.96	1.96	1.96	1.96	3.7	9.8	10.8	950	2917	3630	13.35	3.36	9.8	6.28	A++		
10	07	07	07	07	2.50	1.85	1.85	1.85	1.85	3.7	9.9	10.9	950	2946	3670	13.48	3.36	9.9	6.29	A++		
13	07	07	07	07	3.13	1.69	1.69	1.69	1.69	3.7	9.9	10.9	950	2946	3670	13.48	3.36	9.9	6.29	A++		
16	07	07	07	07	3.56	1.58	1.58	1.58	1.58	3.7	9.9	10.9	950	2946	3670	13.48	3.36	9.9	6.29	A++		
18	07	07	07	07	3.81	1.52	1.52	1.52	1.52	3.7	9.9	10.9	950	2946	3670	13.48	3.36	9.9	6.27	A++		
10	10	07	07	07	2.34	2.34	1.74	1.74	1.74	3.7	9.9	10.9	950	2946	3670	13.48	3.36	9.9	6.29	A++		
13	10	07	07	07	2.95	2.16	1.60	1.60	1.60	3.7	9.9	10.9	950	2946	3670	13.48	3.36	9.9	6.29	A++		
16	10	07	07	07	3.38	2.03	1.50	1.50	1.50	3.7	9.9	10.9	950	2946	3670	13.48	3.36	9.9	6.29	A++		
18	10	07	07	07	3.61	1.95	1.45	1.45	1.45	3.7	9.9	10.9	950	2946	3670	13.48	3.36	9.9	6.27	A++		
13	13	07	07	07	2.73	2.73	1.48	1.48	1.48	3.7	9.9	10.9	950	2946	3670	13.48	3.36	9.9	6.29	A++		
16	13	07	07	07	3.14	2.58	1.39	1.39	1.39	3.7	9.9	10.9	950	2946	3670	13.48	3.36	9.9	6.29	A++		
18	13	07	07	07	3.37	2.49	1.35	1.35	1.35	3.7	9.9	10.9	950	2946	3670	13.48	3.36	9.9	6.27	A++		
16	16	07	07	07	2.97	2.97	1.32	1.32	1.32	3.7	9.9	10.9	950	2946	3670	13.48	3.36	9.9	6.29	A++		
18	16	07	07	07	3.19	2.87	1.28	1.28	1.28	3.7	9.9	10.9	950	2946	3670	13.48	3.36	9.9	6.27	A++		
10	10	10	07	07	2.21	2.21	2.21	1.64	1.64	3.7	9.9	10.9	950	2946	3670	13.48	3.36	9.9	6.29	A++		
13	10	10	07	07	2.80	2.04	2.04	1.51	1.51	3.7	9.9	10.9	950	2946	3670	13.48	3.36	9.9	6.29	A++		
16	10	10	07	07	3.21	1.92	1.92	1.42	1.42	3.7	9.9	10.9	950	2946	3670	13.48	3.36	9.9	6.29	A++		
18	10	10	07	07	3.44	1.86	1.86	1.38	1.38	3.7	9.9	10.9	950	2946	3670	13.48	3.36	9.9	6.27	A++		
13	13	10	07	07	2.60	2.60	1.90	1.40	1.40	3.7	9.9	10.9	950	2946	3670	13.48	3.36	9.9	6.29	A++		
16	13	10	07	07	2.99	2.46	1.79	1.33	1.33	3.7	9.9	10.9	950	2946	3670	13.48	3.36	9.9	6.29	A++		
18	13	10	07	07	3.21	2.38	1.74	1.29	1.29	3.7	9.9	10.9	950	2946	3670	13.48	3.36	9.9	6.27	A++		
16	16	10	07	07	2.84	2.84	1.70	1.26	1.26	3.7	9.9	10.9	950	2946	3670	13.48	3.36	9.9	6.29	A++		
18	16	10	07	07	3.06	2.75	1.65	1.22	1.22	3.7	9.9	10.9	950	2946	3670	13.48	3.36	9.9	6.27	A++		
13	13	13	07	07	2.43	2.43	2.43	1.31	1.31	3.7	9.9	10.9	950	2946	3670	13.48	3.36	9.9	6.29	A++		
16	13	13	07	07	2.80	2.30	2.30	1.25	1.25	3.7	9.9	10.9	950	2946	3670	13.48	3.36	9.9	6.29	A++		
18	13	13	07	07	3.02	2.23	2.23	1.21	1.21	3.7	9.9	10.9	950	2946	3670	13.48	3.36	9.9	6.27	A++		
16	16	13	07	07	2.67	2.67	2.19	1.19	1.19	3.7	9.9	10.9	950	2946	3670	13.48	3.36	9.9	6.29	A++		
18	16	13	07	07	2.88	2.59	2.13	1.15	1.15	3.7	9.9	10.9	950	2946	3670	13.48	3.36	9.9	6.27	A++		
10	10	10	10	07	2.09	2.09	2.09	2.09	1.55	3.7	9.9	10.9	950	2946	3670	13.48	3.36	9.9	6.29	A++		
13	10	10	10	07	2.65	1.94	1.94	1.43	1.43	3.7	9.9	10.9	950	2946	3670	13.48	3.36	9.9	6.29	A++		
16	10	10	10	07	3.05	1.83	1.83	1.36	1.36	3.7	9.9	10.9	950	2946	3670	13.48	3.36	9.9	6.29	A++		
18	10	10	10	07	3.28	1.77	1.77	1.31	1.31	3.7	9.9	10.9	950	2946	3670	13.48	3.36	9.9	6.27	A++		
13	13	10	10	07	2.48	2.48	1.81	1.81	1.34	3.7	9.9	10.9	950	2946	3670	13.48	3.36	9.9	6.29	A++		
16	13	10	10	07	2.86	2.35	1.71	1.71	1.27	3.7	9.9	10.9	950	2946	3670							



RAS-5M34U2AVG-E / TR - Performances in Heating mode

Table with columns: Operating status, Combination (Unit A-E), Unit capacity (kW), Cooling capacity (kW), Power input (W), Operating current (A), EER, and Seasonal efficiencies (PdC, SEER, Class). It lists performance data for 4 units operations (rows 1-56) and 5 units operations (rows 57-120).

Heating, 230 V

* Note : seasonal efficiencies SEER & SCOP with highwall and/or Console combination. Minimum 2 indoor units connected.

RESIDENTIAL LIGHT COMMERCIAL BUSINESS RESIDENTIAL



Solutions for professionals, by professionals

Toshiba Digital and Super Digital Inverter systems provide exceptional operating savings and extremely compact units. With state-of-the-art technologies, flexible controls and improved installation, they ensure comfort and convenience for all business installations.

A complete range of indoor units to suit all commercial applications: ceiling, cassette, ducted, suspended and high-wall. The range has been expanded with maximum cooling capacities of up to 27kW to benefit additional commercial applications with larger volumes.

> LIGHT
COMMERCIAL

LIGHT COMMERCIAL BUSINESS RESIDENTIAL LIGHT COM



INVERTER
SYSTEMS



WHEN THE INVERTER BECOMES DIGITAL

Toshiba technology recreates from power supply signal the ideal wave at the right frequency to perfectly drive the compressor.



ALLIANCE OF HIGH PERFORMANCES AND LOW POWER COMSUMPTION

Digital and Super Digital inverter are able to provide strong capacity, low power consumption, best comfort and reduced energy waste whatever the conditions.

EXTREMELY FLEXIBLE

Featuring the most compact chassis, Digital and Super Digital Inverter use advanced technologies such as DC hybrid control & Twin rotary compressor to operate smoothly from -27 to 52°C no matter the ambiance.

Created by Toshiba.- Inverter technology

SEER up to 9.4	SCOP up to 5.5	11 sizes covering 2.5 to 22.5kW (Cooling), 3.4 to 27kW (Heating)
 Silent operation	CDU down to 46 dB(A)	 Available in 1Ph and 3Ph



RAV
SUPER DIGITAL INVERTER

Super Digital Inverter will maximize your energy savings and keep operating costs to a minimum thanks to Toshiba's legendary Twin Rotary compressors and Vector Controlled Inverter.

Benefit also from all the connectivity and flexibility you have ever dreamt of for guaranteed comfort and exceptional efficiency. Choosing Toshiba's light commercial advanced solutions is the right option for low environmental impact and outstanding durable investments

MAXIMUM EFFICIENCY

Very efficient energy consumption, keeps down operating costs : SEER of 9,40 and SCOP of 5,51 achieved by Toshiba's unrivalled Super Digital Inverter technologies and newly developed components.



- Top class seasonal efficiency
- Lower stand-by power
- Energy monitoring
- Wider operating range

IDEAL COUPLE: DC TWIN ROTARY COMPRESSOR & VECTOR-CONTROLLED INVERTER

The benefits of inverter technology are further optimised in combination with Toshiba twin-rotary compressors. These allows excellent speed control in the capacity range from 20 to 100% capacity; this is an exclusive Toshiba benefit!



PIPING FLEXIBILITY

Super Digital Inverter leads the industry with support for height differences of up to 30 meters on a single system. That is enough height to cover an 8-storey building. Enable the outdoor unit to be installed out of sight increases installation flexibility (only 4 & 5HP).

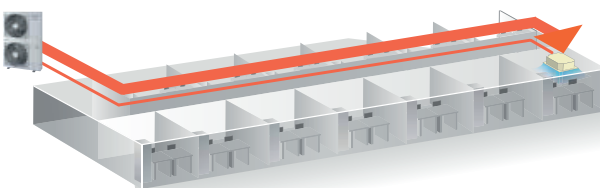

Farthest equivalent length 75m

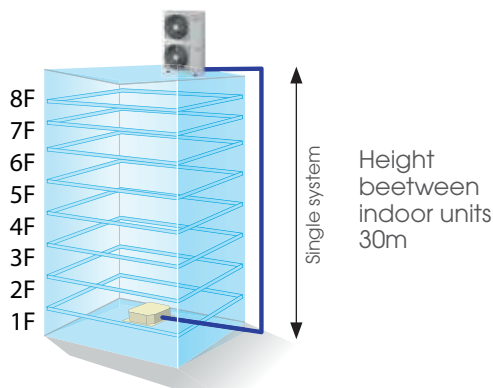

Calculated at 3.5 metres per floor

OPERATING TEMPERATURE RANGE

Heater operation is possible starting from an outdoor temperature of -27°C creates a comfortable space even during cold winters, while cooling operation is possible up to 52°C outdoor temperature. This enables wider applications and use of the system in colder regions.

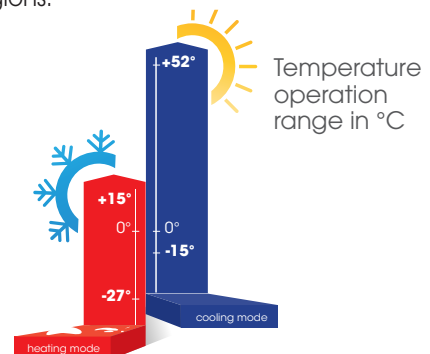

LIGHT COMMERCIAL

RAV DIGITAL INVERTER



Digital Inverter combines compact chassis outdoor units, unrivalled capacity range and large indoor unit line-up for perfect adaptation to any situation. This is the ultimate high efficiency solution for light commercial applications in terms of product reliability and quality.

SMALL AND LIGHT CHASSIS

Less than 900mm up to 5 HP, the Digital inverter is extremely compact and can be installed in very small places. In addition, chassis under 5 HP are less than 70kg.



SMART INVERTER

Hybrid inverter control combines two intelligent controls mechanisms to reach the setpoint temperature as quickly as possible with maximum efficiency:

- the PAM mode, quickly achieves high capacity and desired comfort.
- the PWM mode minimises power input to maximise efficiency.

The result: high efficiency level.

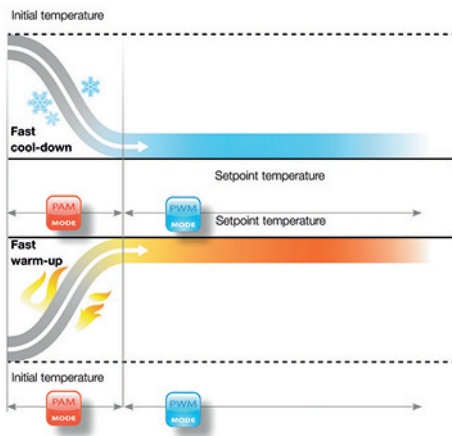

OPERATING TEMPERATURE RANGE

Heater operation is possible starting from an outdoor temperature of -15°C (-25°C for Big DI), while cooling operation is possible at -15°C and up to 46°C (52°C for Big DI R410A) outdoor temperature. This enables wider applications and usage of the system everywhere.

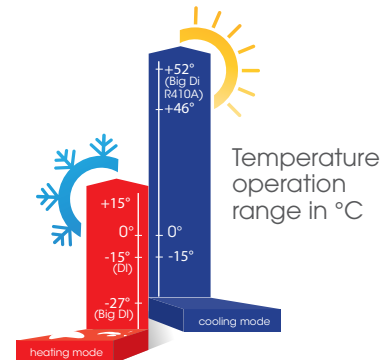



WIDE CAPACITY RANGE

9 sizes from 1 HP to 10HP with 1Ph or 3Ph electrical connections to cover every type of projects from the 15m² room to the 200m² shop in both new construction and refurbishment.

		1HP	1.5HP	2HP	3HP	3.5HP	4HP	5HP	6HP	8HP	10HP
	1Ph	✓	✓	✓	✓	✓	✓	✓	✓		
	3Ph						✓	✓	✓	✓	✓
	1Ph	✓	✓	✓	✓		✓	✓	✓		
	3Ph						✓	✓		✓	✓

CHOOSE YOUR ADAPTED SYSTEM SOLUTION

				CAPACITY IN HP													
				1	1,5	1,7	2	3	3,5	4	5	6	8	10	W twin		
OUTDOOR UNITS	Super Digital Inverter	RAV-GP***1AT(P)-E/-TR		R32				•	•		•	•	•			Twin	
		RAV-SP***4AT(8)(P)-E/-TR		R410A		•	•	•	•			•	•	•			Twin & Triple
	Digital Inverter	RAV-GM***1AT(8)(P)-E/-TR		R32	•	•		•	•	•		•	•	•			Twin
		RAV-SM***4AT(8)(P)-E/-TR		R410A	•	•		•	•			•	•	•			Twin & Triple
	Big Digital Inverter	RAV-GM***1AT8-E/-TR		R32										•	•	Twin, Triple & W-twin	
		RAV-SM2**6AT8-E/-TR		R410A										•	•	Twin, Triple & W-twin	

INDOOR UNITS	4-way Smart Cassette*	RAV-GM***1UTE-E/-TR		R32				•	•		•	•					
	4-way standard cassette	RAV-RM***1UTP-E/-TR		R32/ R410A				•	•	•	•	•					
	Compact 4-way cassette	RAV-RM***1MUT-E/-TR		R32/ R410A	•	•		•									
		RAV-SM***7MUT-E/-TR		R410A			•										
	Standard duct	RAV-RM***1BTP-E/-TR		R32/ R410A				•	•	•	•	•	•				
		RAV-SM***6BTP-E/-TR		R410A		•	•										
	Slim duct	RAV-RM***1SDTE-E/-TR		R32/ R410A	•	•		•									
		RAV-SM***4SDTE-E/-TR		R410A			•										
	High static duct	RAV-RM***1HTP-E/-TR		R32/ R410A										•	•		
	Ceiling	RAV-RM***1CTP-E/TR		R32/ R410A		•		•	•	•	•	•	•				
		RAV-SM***8CTP-E/TR		R410A			•										
	High-wall	RAV-RM***1KRTP-E/TR		R32/ R410A	•	•		•	•	•	•	•					
	Floor standing	RAV-RM***1FT-EN/ES/TR		R32/ R410A				•	•		•	•	•				
	Air curtain	RAV-CT		R410A					•		•	•	•				
	Standard DX Kit	RAV-DXC010		R32/ R410A	•	•		•	•	•	•	•	•				
0/10V DX Kit	RBC-DXC031		R32/ R410A	•	•		•	•	•	•	•	•	•	•			

*Compatible with SDI R32 version only

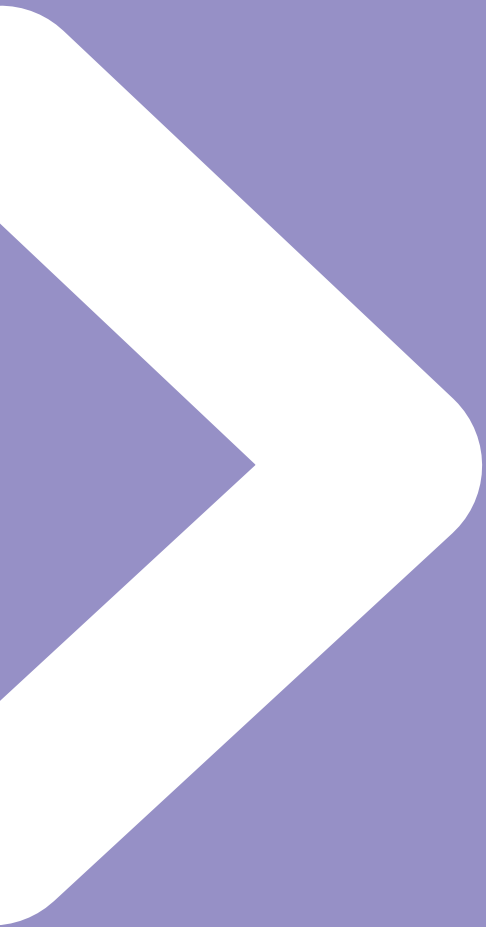

EUROPE

R32

GP_AT(8)
SUPER DIGITAL INVERTER



The Toshiba Super Digital Inverter 1 series is leading energy efficiency, operating range and piping length, to offer the best solution for the majority of commercial projects and large residential applications.

Top class efficiency

- High efficiency SCOP of up to 5.51, thanks to Toshiba inverter technology.

Wide adaptability

- Operating temperature limits from -27°C (Heating) to +52°C (Cooling) allow the system to operate across a wide temperature range.
- Quiet operation.

Flexible

- Can be utilised for single, twin or triple indoor applications.

Easy to maintain

- Removable corner panels for easy access.
- Self-diagnosis function.



SCOP MAX



5.51

CAPACITY



5kW > 16kW

OPERATION



-27°C > +52°C

> Power consumption analysis embedded when SDI 1 series (1Ph only) is combined with the RBC-AMSU51E-ES-EN

Power consumption (Week)

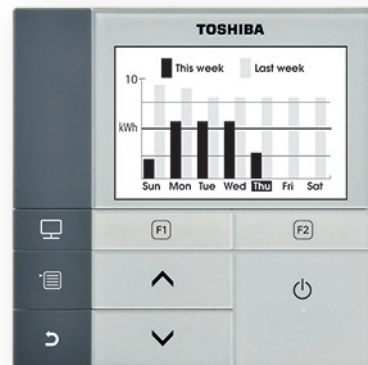

CASSETTE

RAV-GM_UT-E/TR
RAV-RM_UTP-E/TR
RAV-RM_MUT-E/TR



DUCTED

RAV-RM_BTP-E/TR
RAV-RM_SDT-E/TR



CEILING

RAV-RM_CTP-E/TR



HIGH-WALL

RAV-RM_KRTP-E/TR
RAV-GM_KRTP-E/TR



FLOOR
STANDING

RAV-RM_FT-EN/ES/TR



OUTDOOR UNITS

RAV-GP561ATP-E/TR RAV-GP801AT-E/TR RAV-GP1101AT(8)-E
RAV-GP1401AT(8)-E
RAV-GP1601AT8-E

SUPER DIGITAL INVERTER

SUPER DIGITAL INVERTER Physical data outdoor - Single phase

Outdoor unit			RAV-GP561ATP-E/TR 2 HP	RAV-GP801AT-E/TR 3 HP	RAV-GP1101AT-E/TR 4 HP	RAV-GP1401AT-E/TR 5 HP
Air flow	m ³ /h - l/s		2250	3180	6960	6960
Sound pressure level	dB(A)	C	46	46	49	50
Sound power level	dB(A)	C	63	63	66	67
Operating range	°C	C	-15 / 52	-15 / 52	-15 / 52	-15 / 52
Sound pressure level	dB(A)	H	48	48	50	51
Sound power level	dB(A)	H	65	65	67	68
Operating range	°C	H	-27 / 15	-27 / 15	-27 / 15	-27 / 15
Dimensions (HxWxD)	mm		630 x 799 x 299	1050 x 1010 x 370	1550 x 1010 x 370	1550 x 1010 x 370
Weight	kg		45	67	93	93
Compressor type			DC Twin Rotary	DC Twin Rotary	DC Twin Rotary	DC Twin Rotary
Flare connections						
Gas	in		1/2	5/8	5/8	5/8
Liquid	in		1/4	3/8	3/8	3/8
Minimum pipe length	m		3	3	3	3
Maximum pipe length	m		50	50	75	75
Maximum height difference	m		30	30	30	30
Chargeless pipe length	m		20	30	30	30
R32 Refrigerant	kg/TCO ₂ eq		1.35/0.91	1.9/1.28	3.1/2.09	3.1/2.09
Power supply	V-ph-Hz		220/240-1-50	220/240-1-50	220/240-1-50	220/240-1-50

SUPER DIGITAL INVERTER Physical data outdoor - Three Phase

Outdoor unit			RAV-GP1101AT8-E/TR 4 HP	RAV-GP1401AT8-E/TR 5 HP	RAV-GP1601AT8-E/TR 6 HP
Air Flow	m ³ /h - l/s		6060 - 1683	6180 - 1717	6180 - 1717
Sound pressure level	dB(A)	C	49	51	51
Sound power level	dB(A)	C	66	68	68
Operating range	°C	C	-15 / 46	-15 / 46	-15 / 46
Sound pressure level	dB(A)	H	50	52	53
Sound power level	dB(A)	H	67	69	70
Operating range	°C	H	-20 / 15	-20 / 15	-20 / 15
Dimensions (HxWxD)	mm		1340 x 900 x 320	1340 x 900 x 320	1340 x 900 x 320
Weight	kg		95	95	95
Compressor type			DC Twin Rotary	DC Twin Rotary	DC Twin Rotary
Flare connections					
Gas	in		5/8	5/8	5/8
Liquid	in		3/8	3/8	3/8
Minimum pipe length	m		3	3	3
Maximum pipe length	m		75	75	75
Maximum height difference	m		30	30	30
Chargeless pipe length	m		30	30	30
R32 Refrigerant	kg/TCO ₂ eq		2.6/1.75	2.6/1.75	2.6/1.75
Power supply	V-ph-Hz		380/415-3N-50	380/415-3N-50	380/415-3N-50

C: cooling mode
H: heating mode

GM_ATP(8)
DIGITAL INVERTER



Toshiba Digital Inverter brings state-of-the-art inverter technology for the commercial sector, offering considerable advantages in terms of capacity, energy savings, optimised control, lower refrigerant charge and utilising the smallest physical dimensions and lightest range of outdoor units in the industry.

Light and compact

- Up to 12.8 kW in only 890mm height and 69kg.

Wide adaptability

- Compatible with a wide choice of indoor units: 4-way cassette dB(A), 4-way compact cassette, slim duct, standard duct, high wall and ceiling.
- Night operation mode to minimize the outdoor unit sound as low as 33dB (A).

Efficiency & energy savings

- The Vector Intelligent Drive Unit (IPDU) technology ensures.
- Power limitation by 1% step between 50% and 100% load for optimal capacity control.
- Energy monitoring by using RBC-AMSU51E-ES/EN wired remote controller.

Easy to maintain

- Removable corner panels for easy access.
- Auto diagnostic function.
- Self-diagnosis function.

SCOP MAX



4.51

CAPACITY



2.5kW > 16kW

OPERATION



-15°C > +46°C

Toshiba state-of-the-art compressor features a powerful magnetic rotor with great surface area to increase efficiency and reduce the operation noise.

- > Efficiency
- > Reliability
- > 100% Toshiba



CASSETTE

RAV-RM_UTP-E/TR
RAV-RM_MUT-E/TR



DUCTED

RAV-RM_BTP-E/TR
RAV-RM_SDT-E/TR



CEILING

RAV-RM_CTP-E/TR



HIGH-WALL

RAV-RM_KRTP-E/TR
RAV-GM_KRTP-E/TR



FLOOR
STANDING

RAV-RM_FT-EN/ES/TR



OUTDOOR UNITS

RAV-GM561ATP-E/TR
RAV-GM801ATP-E/TR
RAV-GM901ATP-E/TR



RAV-GM1101AT(8)P-E/TR
RAV-GM1401AT(8)P-E/TR



RAV-GM1601AT(8)P-E/TR

DIGITAL INVERTER Physical data outdoor - Single phase

Outdoor unit	Physical data outdoor - Single phase								
		RAV-GM301ATP-E/TR 1 HP	RAV-GM401ATP-E/TR 1.5 HP	RAV-GM561ATP-E/TR 2 HP	RAV-GM801ATP-E/TR 3 HP	RAV-GM901ATP-E/TR 3.5 HP	RAV-GM1101ATP-E/TR 4 HP	RAV-GM1401ATP-E/TR 5 HP	RAV-GM1601ATP-E/TR 6 HP
Air Flow	m ³ /h - l/s	1800 - 500	2200 - 611	2400 - 667	2700 - 750	2900 - 806	4080 - 1133	4200 - 1167	6900 - 1917
Sound pressure level	dB(A) C	46	49	46	48	51	54	55	53
Sound power level	dB(A) C	61	64	63	65	68	70	70	70
Operating range	°C C	-15 / 46	-15 / 46	-15 / 46	-15 / 46	-15 / 46	-15 / 46	-15 / 46	-15 / 46
Sound pressure level	dB(A) H	47	50	48	52	55	57	57	55
Sound power level	dB(A) H	62	65	65	69	72	74	74	72
Operating range	°C H	-15 / 15	-15 / 15	-15 / 15	-15 / 15	-15 / 15	-15 / 15	-15 / 15	-15 / 15
Dimensions (HxWxD)	mm	550 x 780 x 290	550 x 780 x 290	550 x 780 x 290	550 x 780 x 290	630 x 800 x 300	890 x 900 x 320	890 x 900 x 320	1340 x 900 x 320
Weight	kg	33	39	40	44	47	68	68	95
Compressor type		DC Rotary	DC Twin Rotary	DC Twin Rotary	DC Twin Rotary	DC Twin Rotary	DC Twin Rotary	DC Twin Rotary	DC Twin Rotary
Flare connections									
Gas	in	3/8	1/2	1/2	5/8	5/8	5/8	5/8	5/8
Liquid	in	1/4	1/4	1/4	3/8	3/8	3/8	3/8	3/8
Minimum pipe length	m	2	2	5	5	5	5	5	5
Maximum pipe length	m	20	20	30	30	50	50	50	50
Maximum height difference	m	10	10	30	30	30	30	30	30
Chargeless pipe length	m	15	15	20	20	30	30	30	30
Refrigerant	Type/kg/ TeqCO ₂	R32 / 0.6 / 0.4	R32 / 0.9 / 0.6	R32 / 0.9 / 0.6	R32 / 1.3 / 0.9	R32 / 2.0 / 1.3	R32 / 2.1 / 1.4	R32 / 2.1 / 1.6	R32 / 2.4 / 5.0
Power supply	V-ph-Hz	220/240-1-50, 220-1-60	220/240-1-50, 220-1-60	220/240-1-50, 220-1-60	220/240-1-50, 220-1-60	220/240-1-50, 220-1-60	220/240-1-50, 220-1-60	220/240-1-50, 220-1-60	220/240-1-50, 220-1-60

DIGITAL INVERTER Physical data outdoor - Three phase

Outdoor Unit	Physical data outdoor - Three phase			
		RAV-GM1101AT8P-E/TR 4 HP	RAV-GM1401AT8P-E/TR 5 HP	RAV-GM1601AT8P-E/TR 6 HP
Air Flow	m ³ /h - l/s	4080 - 1133	4200 - 1167	6900 - 1917
Sound pressure level	dB(A) C	54	55	53
Sound power level	dB(A) C	70	70	70
Operating range	°C C	-15 / 46	-15 / 46	-15 / 46
Sound pressure level	dB(A) H	57	57	55
Sound power level	dB(A) H	74	74	72
Operating range	°C H	-15 / 15	-15 / 15	-15 / 15
Dimensions (HxWxD)	mm	890 x 900 x 320	890 x 900 x 320	1340 x 900 x 320
Weight	kg	69	69	94
Compressor type		DC Twin Rotary	DC Twin Rotary	DC Twin Rotary
Flare connections				
Gas	in	5/8	5/8	5/8
Liquid	in	3/8	3/8	3/8
Minimum pipe length	m	5	5	5
Maximum pipe length	m	50	50	50
Maximum height difference	m	30	30	30
Chargeless pipe length	m	30	30	30
Refrigerant	Type/kg	R32 / 2.1 / 1.4	R32 / 2.1 / 1.4	R32 / 2.4 / 1.6
Power supply	V-ph-Hz	380/415-3-50, 380-3-60	380/415-3-50, 380-3-60	380/415-3-50, 380-3-60

C: cooling mode
H: heating mode

GM_AT8
BIG DIGITAL INVERTER



Big DI combines very small footprint and all of Toshiba's expertise in terms of efficiency, reliability and connectivity to ensure energy savings as well as perfect comfort all year round.

High efficiency and energy savings

- Top class EER/COP thanks to exclusive Toshiba's inverter twin-rotary compressor.
- Wide capacity range down to 4.6kW to ensure continuous operation whatever the conditions and maximize efficiency.
- Compliance with ERP directive Lot21.

Wide adaptability

- Allows the connection of four indoor units (same type, same capacity).
- Compatible with a large choice of indoor units: 4-way cassette, 4-way compact cassette, slim duct, standard duct, high-wall & ceiling.

Safe and reliable

- Built-in leak detection system.



SCOP MAX



3.51

CAPACITY



19kW > 27kW

OPERATION



-27°C > +46°C

The installation can reach up to 60 m total piping length and 30 m in elevation without additional safety measures.

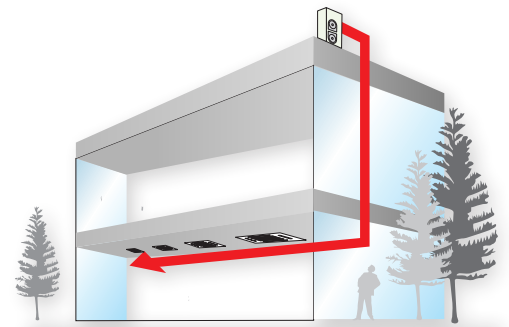

INDOOR UNITS

RAV-RM-DTP-E1/TR1



OUTDOOR UNITS

RAV-GM2241AT8-E/TR
RAV-GM2801AT8-E/TR

BIG DIGITAL INVERTER

BIG DIGITAL INVERTER Physical data outdoor - 3Ph

Outdoor unit			RAV-GM2241 AT8-E/TR 8 HP	RAV-GM2801 AT8-E/TR 10 HP
Air Flow	m ³ /h - l/s		9150 - 2541	10890 - 3025
Sound pressure level	dB(A)	C	58	61
Sound power level	dB(A)	C	76	78
Operating range	°C	C	-15 / 46	-15 / 46
Sound pressure level	dB(A)	H	60	63
Sound power level	dB(A)	H	76	80
Operating range	°C	H	-27 / 15	-27 / 15
Dimensions (HxWxD)	mm		1550 x 1010 x 370	1550 x 1010 x 370
Weight	kg		142	142
Compressor type			DC Twin Rotary	DC Twin Rotary
Flare connections				
Gas	in		1 1/8	1 1/8
Liquid	in		1/2	1/2
Minimum pipe length	m		5	5
Maximum pipe length	m		60	60
Maximum height difference	m		30	30
Chargeless pipe length	m		30	30
R32 refrigerant charge	kg/ TCO ₂ eq		5/10.44	5/10.44
Power supply	V-ph-Hz		380/415-3N-50	380/415-3N-50

C: cooling mode
H: heating mode

RAV-GM2241 AT8J-E	Heavy Corrosion Protection
RAV-GM2801 AT8J-E	Heavy Corrosion Protection

GM_UT
4-WAY SMART CASSETTE



Dedicated for commercial application, the Toshiba Smart Cassette is the perfect mix between comfort, elegance and efficiency.

Efficiency

- Top class SEER and SCOP, thanks to long slit heat exchanger with magic coil treatment, high efficiency fan motor and large opening air conditioning ventilation.
- Energy saving with the occupancy sensor which will automatically switch off the unit if nobody is in the room.

Comfort

- Unique flap design for optimal air distribution.
- Individual setting of louver position: 3 different swing modes: standard, diagonally, opposite or turn around.
- 5 fan steps to precisely control the air flow.

Design

- Simple & elegant design fits various rooms.

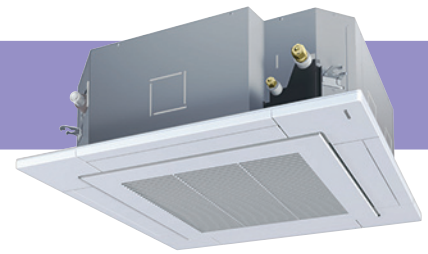

SCOP MAX



5.51

CAPACITY



5kW > 14kW

OPERATION



-27°C > +52°C

Louver position automatically adjusts to prevent cold draught being felt by users

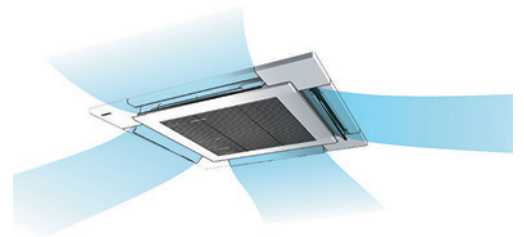

INDOOR UNITS

RAV-GM561UT-E/TR
RAV-GM801UT-E/TR
RAV-GM1101UT-E/TR
RAV-GM1401UT-E/TR



OUTDOOR UNITS

RAV-GP561ATP-E/TR



RAV-GP801AT-E/TR



RAV-GP1101AT-E/TR
RAV-GP1401AT-E/TR



REMOTE CONTROLS

RBC-AX41U(W)-E
TCB-AX32E2



RBC-AMSU51E-ES(EN)
RBC-AMTU31-E
RBC-ASCU11-E

4-WAY SMART CASSETTE
4-WAY SMART CASSETTE Performance data with Super Digital Inverter Series 1

Outdoor unit	RAV-GP561ATP-E/TR		RAV-GP801AT-E/TR		RAV-GP1101AT-E/TR		RAV-GP1401AT-E/TR	
Indoor unit (Cassette)	RAV-GM561UT-E/TR		RAV-GM801UT-E/TR		RAV-GM1101UT-E/TR		RAV-GM1401UT-E/TR	
Cooling capacity	kW		5.0	7.1	10.0	12.5		
Cooling range (min. - max.)	kW		1.2 - 5.6	1.9 - 8.0	3.1 - 12.0	3.1 - 14.0		
Power input (min. - rated - max.)	kW	C	0.19 - 1.2 - 1.99	0.26 - 1.37 - 2.94	0.56 - 1.90 - 2.80	0.56 - 2.91 - 3.40		
EER			4.17	5.18	5.26	4.30		
SEER			8.07	9.40	8.80	8.30		
Energy efficiency class		C	A++	A+++	A+++	-		
Seasonal electricity consumption	kWh/a	C	217	264	398	903		
Heating capacity	kW		5.6	8.0	11.2	14.0		
Heating range (min. - max.)	kW		0.9 - 7.4	1.3 - 11.3	2.6 - 13.0	2.6 - 16.5		
Power input (min. - rated - max.)	kW	H	0.16 - 1.29 - 2.76	0.20 - 1.45 - 3.15	0.41 - 2.18 - 2.98	0.41 - 3.04 - 4.18		
COP	W/W		4.34	5.52	5.14	4.61		
SCOP			5.01	5.51	5.00	4.97		
Energy efficiency class		H	A++	A+++	A++	-		
Seasonal electricity consumption	kWh/a	H	1061	1294	2573	2702		

4-WAY SMART CASSETTE Physical data indoor

Indoor unit	RAV-GM561UT-E/TR		RAV-GM801UT-E/TR		RAV-GM1101UT-E/TR		RAV-GM1401UT-E/TR	
Air flow (H/L)	m ³ /h - l/s		1050/750 - 291/208	1920/810 - 533/225	2250/1050 - 625/291	2250/1170 - 625/325		
Sound pressure level (H-M-L)	dB(A)		32-29-26	42-35-27	48-40-31	48-41-33		
Sound power level (H-M-L)	dB(A)		48-45-43	56-49-43	61-54-46	61-55-48		
Dimensions (HxWxD)	mm		256 × 840 × 840	319 × 840 × 840	319 × 840 × 840	319 × 840 × 840		
Weight	kg		20	25	25	25		
Panel dimensions (HxWxD)	mm		30×950×950	30×950×950	30×950×950	30×950×950		
Panel weight	kg		5	5	5	5		

C: cooling mode
H: heating mode

RM_UTP
4-WAY CASSETTE



4-way Cassette is designed to provide uniform air distribution and total comfort; it is the ideal solution for small commercial application.

Comfort

- Two louver shape option: straight flow louver and wide flow louver; optimum air distribution.
- Individual setting of louver position: 3 different swing modes: standard, diagonally, opposite, turn around.
- Wide air flow in all directions.

Reliability

- Self-cleaning function and Ag-ion tip for anti-mould in drain cap.
- Built-in high-lift drain pump.

Easy to install

- Compact chassis with only 256mm height (sizes 5 and 8).
- Light-weight unit, for easy and quick installation.



SCOP MAX



5.22

CAPACITY



5kW > 16kW

OPERATION



-27°C > +52°C

Optimal air diffusion up to 4.6m ceiling height!

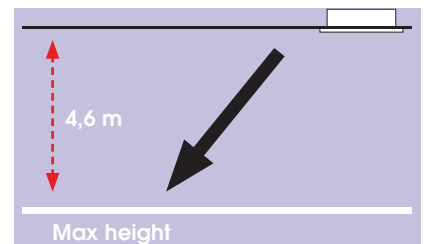

INDOOR UNITS

- RAV-RM561UTP-E/TR
- RAV-RM801UTP-E/TR
- RAV-GM901UTP-E/TR
- RAV-RM1101UTP-E/TR
- RAV-RM1401UTP-E/TR
- RAV-RM1601UTP-E/TR

SDI



OUTDOOR UNITS

- RAV-GP561ATP-E/TR
- RAV-GP801AT-E/TR
- RAV-GP1101AT(8)-E/TR
- RAV-GP1401AT(8)-E/TR
- RAV-GP1601AT8-E/TR

DI



- RAV-GM561ATP-E/TR
- RAV-GM801ATP-E/TR
- RAV-GM901ATP-E/TR
- RAV-GM1101AT(8)PE/TR
- RAV-GM1401AT(8)P-E/TR
- RAV-GM1601AT(8)P-E/TR



REMOTE CONTROLS

- RBC-AXU31U-E
- RBC-AXU31-E



- RBC-AMSU51E-ES(EN)
- RBC-AMTU31-E
- RBC-ASCU11-E

4-WAY CASSETTE

4-WAY CASSETTE Performance data with Super Digital Inverter Series 1 1Ph

Outdoor unit			RAV-GP561ATP-E/TR	RAV-GP801AT-E/TR	RAV-GP1101AT-E/TR	RAV-GP1401AT-E/TR
Indoor unit (Cassette)			RAV-RM561UTP-E/TR	RAV-RM801UTP-E/TR	RAV-RM1101UTP-E/TR	RAV-RM1401UTP-E/TR
Cooling capacity	kW		5.0	7.1	10.0	12.5
Cooling range (min. - max.)	kW		1.2 - 5.6	1.9 - 8.0	3.1 - 12.0	3.1 - 14.0
Power input (min. - rated - max.)	kW	C	0.19 - 1.22 - 1.97	0.26 - 1.58 - 3.15	0.53 - 2.13 - 3.05	0.53 - 3.16 - 3.55
EER			4.1	4.49	4.69	3.96
SEER			7.67	8.80	8.65	8.15
Energy efficiency class		C	A++	A+++	A+++	-
Seasonal electricity consumption	kWh/a	C	230	282	405	920
Heating capacity	kW		5.6	8.0	11.2	14.0
Heating range (min. - max.)	kW		0.9 - 8.1	1.3 - 11.3	2.6 - 13.0	2.6 - 16.5
Power input (min. - rated - max.)	kW	H	0.16 - 1.3 - 2.76	0.20 - 1.77 - 3.47	0.40 - 2.34 - 3.08	0.40 - 3.21 - 4.38
COP	W/W		4.31	4.52	4.79	4.36
SCOP			4.3	5.22	4.73	4.72
Energy efficiency class		H	A+	A+++	A++	-
Seasonal electricity consumption	kWh/a	H	1071	1367	2719	2844

4-WAY CASSETTE Performance data with Super Digital Inverter Series 1 3Ph

Outdoor unit			RAV-GP1101AT8-E/TR	RAV-GP1401AT8-E/TR	RAV-GP1601AT8-E/TR
Indoor unit (Cassette)			RAV-RM1101UTP-E/TR	RAV-RM1401UTP-E/TR	RAV-RM1601UTP-E/TR
Cooling capacity	kW		10.0	12.5	14.0
Cooling range (min. - max.)	kW		2.6 - 12.0	2.6 - 14.0	2.6 - 16.0
Power input (min. - rated - max.)	kW	C	0.66 - 2.32 - 3.60	0.66 - 3.42 - 4.40	0.66 - 4.34 - 5.70
EER			4.31	3.65	3.23
SEER			7.1	7.01	6.72
Energy efficiency class		C	A++	-	-
Seasonal electricity consumption	kWh/a	C	492	1069	1249
Heating capacity	kW		11.2	14.0	16.0
Heating range (min. - max.)	kW		2.4 - 15.6	2.4 - 18.0	2.4 - 19.0
Power input (min. - rated - max.)	kW	H	0.53 - 2.41 - 4.30	0.53 - 3.41 - 5.50	0.53 - 4.28 - 6.51
COP	W/W		4.65	4.11	3.74
SCOP			4.36	4.36	4.36
Energy efficiency class		H	A+	-	-
Seasonal electricity consumption	kWh/a	H	3760	3836	3948

4-WAY CASSETTE Performance data with Digital Inverter Series 1 1Ph & 3Ph

Outdoor unit			RAV-GM561ATP-E/TR	RAV-GM801ATP-E/TR	RAV-GM901ATP-E/TR	RAV-GM1101AT(8)P-E/TR	RAV-GM1401AT(8)P-E/TR	RAV-GM1601AT(8)P-E/TR
Indoor unit (4-way Cassette)			RAV-RM561UTP-E/TR	RAV-RM801UTP-E/TR	RAV-GM901UTP-E/TR	RAV-RM1101UTP-E/TR	RAV-RM1401UTP-E/TR	RAV-RM1601UTP-E/TR
Cooling capacity	kW		5.0	6.7	8.0	9.5	12.0	14.0
Cooling range (min. - max.)	kW		1.5 - 5.6	1.5 - 8.0	1.9 - 8.8	3.0 - 11.2	3.0 - 13.2	3.0 - 16.0
Power input (min. - rated - max.)	kW	C	0.26 - 1.56 - 1.86	0.26 - 2.22 - 2.60	2.42	0.60 - 2.87 - 4.10	0.60 - 4.29 - 4.71	4.49
EER			3.21	3.02	3.30	3.31	2.8	3.12
SEER			6.34	5.81	7.00	6.15	5.71	6.30
Energy efficiency class		C	A++	A+	A++	A++	A+	-
Seasonal electricity consumption	kWh/a	C	276	403	389	540	736	778
Heating capacity	kW		5.3	7.7	9.0	11.2	13.0	16.0
Heating range (min. - max.)	kW		1.5 - 6.3	1.5 - 9.0	1.6 - 9.9	3.0 - 13.0	3.0 - 16.0	3.0 - 18.0
Power input (min. - rated - max.)	kW	H	0.26 - 1.36 - 2.08	0.26 - 2.13 - 3.03	2.65	0.60 - 2.93 - 4.30	0.60 - 3.46 - 4.50	4.43
COP	W/W		3.90	3.62	3.72	3.82	3.76	3.61
SCOP			4.60	4.42	4.60	4.28	4.29	4.35
Energy efficiency class		H	A++	A+	A++	A+	A+	-
Seasonal electricity consumption	kWh/a	H	852	1615	1917	2615	2611	2575

4-WAY CASSETTE Physical data indoor

Indoor unit		RAV-RM561UTP-E/TR	RAV-RM801UTP-E/TR	RAV-GM901UTP-E/TR	RAV-RM1101UTP-E/TR	RAV-RM1401UTP-E/TR	RAV-RM1601UTP-E/TR
Air Flow (H/L)	m ³ /h - l/s	1050/780 - 291/217	1230/810 - 341/225	1600/900 - 444/250	2010/1170 - 558/325	2100/1230 - 583/341	2130/1260 - 592/350
Sound pressure level (H-M-L)	dB(A)	32-29-28	35-31-28	40-36-33	43-38-33	44-38-34	45-40-36
Sound power level (H-M-L)	dB(A)	47-44-43	50-46-43	55-51-48	58-53-48	59-53-49	60-55-51
Dimensions (HxWxD)	mm	256 x 840 x 840	256 x 840 x 840	319 x 840 x 840	319 x 840 x 840	319 x 840 x 840	319 x 840 x 840
Weight	kg	20	20	24	24	24	24
Panel dimensions (HxWxD)	mm	30 x 950 x 950	30 x 950 x 950	30 x 950 x 950	30 x 950 x 950	30 x 950 x 950	30 x 950 x 950
Panel weight	kg	4.2	4.2	4.2	4.2	4.2	4.2

C: cooling mode
H: heating mode

RM_MUT
COMPACT 4-WAY CASSETTE



The compact 4 way cassette has been especially designed for small commercial application where a compact efficient unit is needed.

Design

- Elegant and Flat appearance
- Fit within the T-bar of grid ceiling : 620mm X 620mm.

Comfort

- Individual setting of louver position: 3 different swing mode: standard, diagonally, opposite, turn around.
- 5 steps air flow.

Easy to install

- Compact and thin chassis with only 256mm height
- Built-in high-lift drain pump
- Light-weight unit, for easy and quick installation.

SCOP MAX



4.60

CAPACITY



2.5kW > 6kW

OPERATION



-27°C > +52°C

Occupancy sensor switches off automatically the unit if nobody is in the room to save energy.

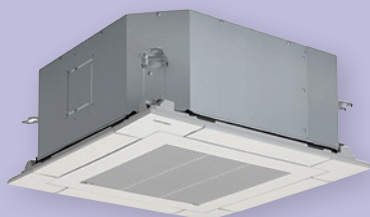

INDOOR UNITS

RAV-RM301MUT-E/TR
 RAV-RM401MUT-E/TR
 RAV-RM561MUT-E/TR

SDI



OUTDOOR UNITS

RAV-GP561ATP-E/TR

DI



RAV-GM301ATP-E/TR
 RAV-GM401ATP-E/TR
 RAV-GM561ATP-E/TR



REMOTE CONTROLS

RBC-AXU31UM-E
 RBC-AXU31-E



RBC-AMSU51E-ES(EN)
 RBC-AMTU31-E
 RBC-ASCU11-E

COMPACT 4-WAY CASSETTE

COMPACT 4-WAY CASSETTE Performance data with Super Digital Inverter Series 1

Outdoor unit			RAV-GP561ATP-E/TR
Indoor unit (600X600 Cassette)			RAV- RM561MUT-E/TR
Cooling capacity	kW		5.0
Cooling range (min. - max.)	kW		1.2 - 5.6
Power input (min. - rated - max.)	kW	C	0.19 - 1.56 - 1.97
EER			3.21
SEER			6.02
Energy efficiency class		C	A+
Seasonal electricity consumption	kWh/a	C	291
Heating capacity	kW		5.6
Heating range (min. - max.)	kW		0.9 - 7.0
Power input (min. - rated - max.)	kW	H	0.16 - 1.60 - 2.36
COP	W/W		3.50
SCOP			4.30
Energy efficiency class		H	A+
Seasonal electricity consumption	kWh/a	H	1237

COMPACT 4-WAY CASSETTE Performance data with Digital Inverter Series 1

Outdoor unit			RAV-GM301ATP-E/TR	RAV-GM401ATP-E/TR	RAV-GM561ATP-E/TR
Indoor unit (600X600 Cassette)			RAV- RM301MUT-E/TR	RAV- RM401MUT-E/TR	RAV- RM561MUT-E/TR
Cooling capacity	kW		2.5	3.6	5.0
Cooling range (min. - max.)	kW		0.9 - 3.0	0.9 - 4.0	1.5 - 5.6
Power input (min. - rated - max.)	kW	C	0.25 - 0.59 - 0.82	0.18 - 0.90 - 2.00	0.30 - 1.64 - 1.86
EER			4.24	4.00	3.05
SEER			5.94	5.76	5.69
Energy efficiency class		C	A+	A+	A+
Seasonal electricity consumption	kWh/a	C	147	219	307
Heating capacity	kW		3.4	4.0	5.3
Heating range (min. - max.)	kW		0.8 - 4.5	0.8 - 5.0	1.5 - 6.3
Power input (min. - rated - max.)	kW	H	0.17 - 0.76 - 1.40	0.14 - 0.95 - 1.70	0.30 - 1.47 - 2.40
COP	W/W		4.47	4.21	3.61
SCOP			4.70	4.44	4.37
Energy efficiency class		H	A++	A+	A+
Seasonal electricity consumption	kWh/a	H	685	851	897

COMPACT 4-WAY CASSETTE Physical data indoor

Indoor unit			RAV- RM301MUT-E/TR	RAV- RM401MUT-E/TR	RAV- RM561MUT-E/TR
Air flow (H/L)	m ³ /h - l/s		640/440 - 177/122	660/468 - 183/130	798/546 - 221/152
Sound pressure level (H-M-L)	dB(A)		38 - 36 - 30	41 - 36 - 32	44 - 39 - 35
Sound power level (H-M)	dB(A)		53 - 51 - 45	56 - 51 - 47	59 - 54 - 50
Dimensions (HxWxD)	mm		256 x 575 x 575	256 x 575 x 575	256 x 575 x 575
Weight	kg		15	15	15
Panel dimensions (HxWxD)	mm		12 x 620 x 620	12 x 620 x 620	12 x 620 x 620
Panel weight	kg		2.5	2.5	2.5

C: cooling mode
H: heating mode
H-M-L: High - Medium - Low speed

RM_BTP
STANDARD DUCT



Whatever the shape of the room, this flexible model ensures a uniform temperature and air distribution for optimal end user comfort.

Adaptability

- Up to 120Pa available pressure: thanks to DC fan motor.
- Flexible design, allows the inlet air configuration to be configured between the standard rear inlet design or as an alternative, from the underside of the unit. There is also a provision for a fresh air intake supply via a pre-punched knockout hole.
- Compact and thin chassis, measuring just 275mm in height.

Easy to install

- Built-in high-lift drain pump.
- PC board panel easily accessible from the side of the unit.
- Optional air discharge spigot.

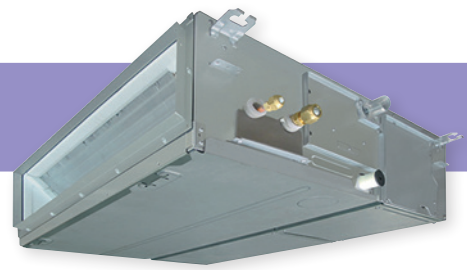

SCOP MAX



4.81

CAPACITY



5kW > 16kW

OPERATION



-27°C > +52°C

Airzone compatibility: multiple individual controlled rooms with only one indoor unit.

compatible with
AIRZONE

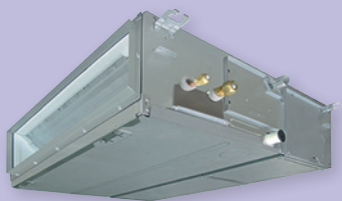

INDOOR UNITS

SDI



OUTDOOR UNITS

DI



REMOTE CONTROLS

- RAV-RM561BTP-E/TR
- RAV-RM801BTP-E/TR
- RAV-GM901BTP-E/TR
- RAV-RM1101BTP-E/TR
- RAV-RM1401BTP-E/TR
- RAV-RM1601BTP-E/TR

- RAV-GP561ATP-E/TR
- RAV-GP801AT-E/TR
- RAV-GP1101AT(8)-E/TR
- RAV-GP1401AT(8)-E/TR
- RAV-GP1601AT8-E/TR

- RAV-GM561ATP-E/TR
- RAV-GM801ATP-E/TR
- RAV-GM901ATP-E/TR
- RAV-GM1101AT(8)PE/TR
- RAV-GM1401AT(8)P-E/TR
- RAV-GM1601AT(8)P-E/TR

RBC-AXU31-E

RBC-AMSU51E-ES(EN)
RBC-AMTU31-E
RBC-ASCU11-E

STANDARD DUCT

STANDARD DUCT Performance data with Super Digital Inverter Series 1 1Ph

Outdoor unit			RAV-GP561ATP-E/TR	RAV-GP801AT-E/TR	RAV-GP1101AT-E/TR	RAV-GP1401AT-E/TR
Indoor unit (Standard Duct)			RAV-RM561BTP-E/TR	RAV-RM801BTP-E/TR	RAV-RM1101BTP-E/TR	RAV-RM1401BTP-E/TR
Cooling capacity	kW		5.0	7.1	10.0	12.5
Cooling range (min. - max.)	kW		1.2 - 5.6	1.9 - 8.0	3.1 - 12.0	3.1 - 14.0
Power input (min. - rated - max.)	kW	C	0.19 - 1.52 - 1.99	0.26 - 1.63 - 3.20	0.65 - 2.40 - 3.63	0.65 - 3.57 - 3.97
EER			3.29	4.36	4.17	3.50
SEER			5.60	7.50	6.60	6.06
Energy efficiency class		C	A+	A++	A++	-
Seasonal electricity consumption	kWh/a	C	312	331	530	1237
Heating capacity	kW		5.6	8.0	11.2	14.0
Heating range (min. - max.)	kW		0.9 - 7.4	1.3 - 11.3	2.6 - 13.0	2.6 - 16.5
Power input (min. - rated - max.)	kW	H	0.16 - 1.61 - 2.76	0.20 - 1.85 - 3.55	0.47 - 2.73 - 3.38	0.47 - 3.63 - 4.43
COP	W/W		3.48	4.32	4.10	3.86
SCOP			4.24	4.81	4.24	4.24
Energy efficiency class		H	A+	A++	A+	-
Seasonal electricity consumption	kWh/a	H	1254	1484	3032	3168

STANDARD DUCT Performance data with Super Digital Inverter Series 1 3Ph

Outdoor unit			RAV-GP1101AT8-E/TR	RAV-GP1401AT8-E/TR	RAV-GP1601AT8-E/TR
Indoor unit (Standard Duct)			RAV-RM1101BTP-E/TR	RAV-RM1401BTP-E/TR	RAV-RM1601BTP-E/TR
Cooling capacity	kW		10.0	12.5	14.0
Cooling range (min. - max.)	kW		2.6 - 12.0	2.6 - 14.0	2.6 - 16.0
Power input (min. - rated - max.)	kW	C	0.66 - 2.58 - 4.01	0.66 - 3.81 - 4.89	0.66 - 4.49 - 6.50
EER			3.87	3.28	3.12
SEER			5.70	5.48	5.36
Energy efficiency class		C	A+	-	-
Seasonal electricity consumption	kWh/a	C	566	1169	1285
Heating capacity	kW		11.2	14.0	16
Heating range (min. - max.)	kW		2.40 - 15.6	2.40 - 18.0	2.4 - 19.0
Power input (min. - rated - max.)	kW	H	0.53 - 2.76 - 4.42	0.53 - 3.66 - 5.71	0.53 - 4.00 - 6.96
COP	W/W		4.06	3.83	3.50
SCOP			4.14	3.94	3.93
Energy efficiency class		H	A+	-	-
Seasonal electricity consumption	kWh/a	H	3331	3998	4003

STANDARD DUCT Performance data with Digital Inverter Series 1 1Ph & 3Ph

Outdoor unit			RAV-GM561ATP-E/TR	RAV-GM801ATP-E/TR	RAV-GM901ATP-E/TR	RAV-GM1101AT(8)P-E/TR	RAV-GM1401AT(8)P-E/TR	RAV-GM1601AT(8)P-E/TR
Indoor unit (Standard Duct)			RAV-RM561BTP-E/TR	RAV-RM801BTP-E/TR	RAV-RM901BTP-E/TR	RAV-RM1101BTP-E/TR	RAV-RM1401BTP-E/TR	RAV-RM1601BTP-E/TR
Cooling capacity	kW		5.0	6.7	8.0	9.5	12.1	14.0
Cooling range (min. - max.)	kW		1.5 - 5.6	1.5 - 8.0	1.9 - 8.8	3.0 - 11.2	3.0 - 13.2	3.0 - 16.0
Power input (min. - rated - max.)	kW	C	0.31 - 1.83 - 2.05	0.31 - 2.38 - 2.76	2.67	0.60 - 2.99 - 4.50	0.60 - 4.42 - 4.71	5.13
EER			2.73	2.82	3.00	3.18	2.74	2.73
SEER			5.28	5.20	6.10	5.28	5.36	5.30
Energy efficiency class		C	A	A	A++	A	-	-
Seasonal electricity consumption	kWh/a	C	332	451	459	629	-	-
Heating capacity	kW		5.3	7.7	9.0	11.2	13.0	16.0
Heating range (min. - max.)	kW		1.5 - 6.3	1.5 - 9.0	1.6 - 9.9	3.0 - 13.0	3.0 - 16.0	3.0 - 18.0
Power input (min. - rated - max.)	kW	H	0.31 - 1.62 - 2.47	0.31 - 2.32 - 3.18	2.65	0.60 - 2.99 - 4.00	0.60 - 3.60 - 4.55	4.69
COP	W/W		3.27	3.32	3.40	3.75	3.61	3.41
SCOP			4.08	4.13	4.60	4.19	4.19	3.90
Energy efficiency class		H	A+	A+	A++	A+	-	-
Seasonal electricity consumption	kWh/a	H	960	1728	1917	2537	-	-

STANDARD DUCT Physical data indoor

Indoor unit			RAV-RM561BTP-E/TR	RAV-RM801BTP-E/TR	RAV-GM901BTP-E/TR	RAV-RM1101BTP-E/TR	RAV-RM1401BTP-E/TR	RAV-RM1601BTP-E/TR
Air Flow (H/L)	m³/h - l/s		800/480 - 222/133	1200/720 - 333/200	1700/1000 - 472/278	2100/1260 - 583/350	2100/1260 - 583/350	2100/1260 - 583/350
Sound pressure level (H-M-L)*	dB(A)		33-29-25	34-30-26	37-33-30	40-36-33	40-36-33	40-36-33
Sound power level (H-M-L)*	dB(A)		48-44-40	49-45-41	52-48-45	55-51-48	55-51-48	55-51-48
Dimensions (HxWxD)	mm		275 x 700 x 750	275 x 1000 x 750	275 x 1400 x 750	275 x 1400 x 750	275 x 1400 x 750	275 x 1400 x 750
Weight	kg		23	30	40	40	40	40
External static pressure (stand/upper limit)	Pa		30/120	30/120	50/120	50/120	50/120	50/120

C: cooling mode
H: heating mode
*bottom air inlet

▶ LIGHT COMMERCIAL

RM_SDT
SLIM DUCT

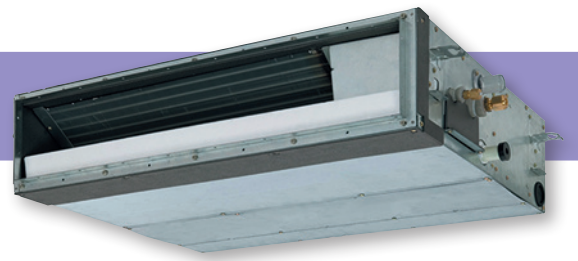

Whether installed in a ceiling void or in a false ceiling, Toshiba's slim duct offers the ultimate technology, with exceptional energy savings, high performance and easy installation.

Adaptability

- Up to 50Pa available pressure with four steps set up.
- Easy to combine with different types of air diffusers.
- Flexible design, allows the inlet air configuration to be configured between the standard rear inlet design or as an alternative, from the underside of the unit.

There is also a provision for a fresh air intake supply via a pre-punched knockout hole.

Easy to install

- Slimline design, with a height of just 21cm and a weight of 22kg, gives increased flexibility when designing and installing the system.
- Natural drain discharge or built-in drain pump to manage condensates.

SCOP MAX



4.48

CAPACITY



2.5kW > 6kW

OPERATION



-27°C > +52°C

Cleaned prefilter included compatible with rear or underside air suction.

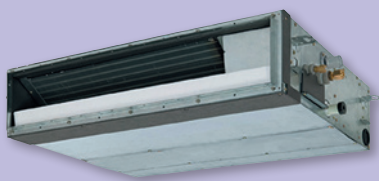
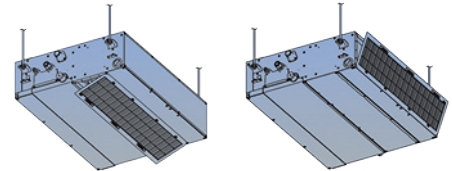

INDOOR UNITS

RAV-RM301SDT-E/TR
RAV-RM401SDT-E/TR
RAV-RM561SDT-E/TR

SDI



OUTDOOR UNITS

RAV-GP561ATP-E/TR

DI



RAV-GM301ATP-E/TR
RAV-GM401ATP-E/TR
RAV-GM561ATP-E/TR



REMOTE CONTROLS

RBC-AXU31-E



RBC-AMSU51E-ES(EN)
RBC-AMTU31-E
RBC-ASCU11-E

SLIM DUCT

SLIM DUCT Performance data with Super Digital Inverter Series 1

Outdoor unit		RAV-GP561ATP-E/TR	
Indoor unit (Slim duct)		RAV-RM561SDT-E/TR	
Cooling capacity	kW	5.0	
Cooling range (min. - max.)	kW	1.2 - 5.6	
Power input (min. - rated - max.)	kW C	0.19 - 1.56 - 1.98	
EER		3.21	
SEER		5.77	
Energy efficiency class	C	A+	
Seasonal electricity consumption	kWh/a C	303	
Heating capacity	kW	5.6	
Heating range (min. - max.)	kW	0.9 - 7.0	
Power input (min. - rated - max.)	kW H	0.16 - 1.58 - 2.66	
COP	W/W	3.54	
SCOP		4.20	
Energy efficiency class	H	A+	
Seasonal electricity consumption	kWh/a H	1266	

SLIM DUCT Performance data with Digital Inverter Series 1

Outdoor unit		RAV-GM301ATP-E/TR		RAV-GM401ATP-E/TR		RAV-GM561ATP-E/TR	
Indoor unit (Slim duct)		RAV- RM301SDT-E/TR		RAV- RM401SDT-E/TR		RAV- RM561SDT-E/TR	
Cooling capacity	kW	2.5		3.6		5.0	
Cooling range (min. - max.)	kW	0.9 - 3.0		0.9 - 4.0		1.5 - 5.6	
Power input (min. - rated - max.)	kW C	0.25 - 0.56 - 0.82		0.18 - 0.93 - 2.00		0.32 - 1.91 - 2.75	
EER		4.46		3.87		2.62	
SEER		6.29		5.86		5.14	
Energy efficiency class	C	A++		A+		A	
Seasonal electricity consumption	kWh/a C	129		215		340	
Heating capacity	kW	3.4		4.0		5.3	
Heating range (min. - max.)	kW	0.8 - 4.5		0.8 - 5.0		1.5 - 6.3	
Power input (min. - rated - max.)	kW H	0.17 - 0.86 - 1.40		0.14 - 0.97 - 1.70		0.32 - 1.50 - 2.40	
COP	W/W	3.95		4.12		3.53	
SCOP		4.60		4.01		4.16	
Energy efficiency class	H	A++		A+		A+	
Seasonal electricity consumption	kWh/a H	907		1337		1517	

SLIM DUCT Physical data indoor

Indoor unit		RAV- RM301SDT-E/TR		RAV- RM401SDT-E/TR		RAV- RM561SDT-E/TR	
Air flow (H/L)	m ³ /h - l/s	660/480 - 183/133		690/522 - 192/145		780/582 - 217/162	
Sound pressure level (H-M-L)*	dB(A)	39-36-33		39-36-33		45-40-36	
Sound power level (H-M-L)*	dB(A)	52-48-44		52-48-44		55-53-48	
Dimensions (HxWxD)	mm	210 x 845 x 645		210 x 845 x 645		210 x 845 x 645	
Weight	kg	22		22		22	
External static pressure (stand/upper limit)	Pa	30(45-5)		30(45-5)		30(45-5)	

C: cooling mode
H: heating mode
*bottom air inlet

RM_DTP
HIGH STATIC DUCT



Toshiba's high static pressure ducts are specially designed to air-condition large open spaces thanks to their impressive air flow characteristics.

Comfort

- 3-speed DC fan to provide correct air flow and maximise energy savings.
- Compatible with metal or textile ducts.

Adaptability

- Lightweight design for quick and easy installation.
- With 7-step settings, the static pressure of the duct can range from 52 to 250 Pa.
- Up to 5,600 m³/h air flow to efficiently blow the air into large rooms.

Easy to install

- Electronic components accessible from the outside of the unit.
- Air filter and drain pump are available as an option.



SCOP MAX



3.78

CAPACITY



19kW > 27kW

OPERATION



-27°C > +46°C

The DTP high static pressure duct is compatible with textile duct diffusion system to blow the air smoothly throughout the room.



INDOOR UNITS

RAV-RM2241DTP-E1/TR1
RAV-RM2801DTP-E1/TR1



OUTDOOR UNITS

RAV-GM2241AT8-E/TR
RAV-GM2801AT8-E/TR



REMOTE CONTROLS

RBC-AXU31-E

RBC-AMSU51E-ES(EN)
RBC-AMTU31E
RBC-ASCU11-E

HIGH STATIC DUCT

HIGH STATIC DUCT - SERIES 1 Performance data with Big DI Inverter Series 4

Outdoor unit	RAV-GM2241AT8-E/TR		RAV-GM2801AT8-E/TR
Indoor unit (High Static duct)	RAV-RM2241DTP-E1/TR1		RAV-RM2801DTP-E1/TR1
Cooling capacity	kW	19.0	22.5
Cooling range (min. - max.)	kW	4.6 - 22.4	4.6 - 27.0
Power input (min. - rated - max.)	kW C	1.27 - 5.86 - 9.05	1.27 - 7.98 - 11.87
EER	W/W	3.24	2.82
SEER		5.82	5.49
Energy efficiency class	C	-	-
Seasonal electricity consumption	kWh/a C	2468	2928
Heating capacity	kW	22.4	27.0
Heating range (min. - max.)	kW	4.6 - 25.0	4.6 - 31.5
Power input (min. - rated - max.)	kW H	1.27 - 5.71 - 10.15	1.27 - 7.52 - 13.83
COP	W/W	3.92	3.59
SCOP		3.78	3.69
Energy efficiency class	H	-	-
Seasonal electricity consumption	kWh/a H	7174	8136

HIGH STATIC DUCT - SERIES 1 Physical data indoor

Indoor unit	RAV-RM2241DTP-E1/TR1		RAV-RM2801DTP-E1/TR1
Air Flow	m ³ /h - l/s	3800 - 1055	4800 - 1333
Sound pressure level (back)	dB(A)	44	46
Sound power level (back)	dB(A)	79	81
Dimensions (HxWxD)	mm	448 x 1400 x 900	448 x 1400 x 900
Weight	kg	97	97
Upper limit/middle/standard	Pa	250/150/50	250/150/50

C: cooling mode
H: heating mode

RM_CTP
CEILING



The simple, yet elegant design helps to create a pleasant and relaxing environment, quickly conditioning the room air to the desired temperature.

Comfort

- Automatic louvre control for all year round comfort and efficiency.
- Low noise levels, thanks to high diameter fan and DC motor.

Reliability

- Self-cleaning function, enables the air flow to remain constant and fresh and reduces the frequency of service visits.

Easy to install and to maintain

- This design, represents the best possible solution, where there is a lack of space or absence of a ceiling void.

Adaptability

- Anti-bacterial drain point available as an option.
- Connecting kit available as an option for external I/O without local relay preparation.



SCOP MAX



5.05

CAPACITY



3.6kW > 16kW

OPERATION



-27°C > +52°C

The airflow angle is automatically set to the most suitable setting according to the cooling or heating needs.

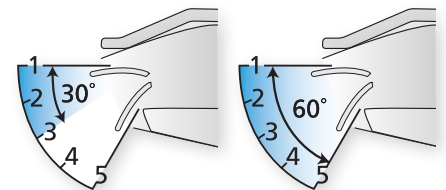

INDOOR UNITS

RAV-RM401CTP-E/TR
RAV-RM561CTP-E/TR
RAV-RM801CTP-E/TR
RAV-RM901CTP-E/TR
RAV-RM1101CTP-E/TR

RAV-RM1401CTP-E/TR
RAV-RM1601CTP-E/TR

SDI



OUTDOOR UNITS

RAV-GP516ATP-E/TR
RAV-GP801AT-E/TR
RAV-GP1101AT(8)-E/TR
RAV-GP1401AT(8)-E/TR
RAV-GP1601AT8-E/TR

DI



RAV-GM401ATP-E/TR
RAV-GM561ATP-E/TR
RAV-GM801ATP-E/TR
RAV-GM901ATP-E/TR
RAV-GM1101AT(8)P-E/TR
RAV-GM1401AT(8)P-E/TR
RAV-GM1601AT(8)P-E/TR



REMOTE CONTROLS

RBC-AXU31C-E
RBC-AXU31-E



RBC-AMTSU31-E
RBC-AMTSU31-E
RBC-ASCU11-E

CEILING

CEILING Performance data with Super Digital Inverter Series 1 1Ph

Outdoor unit			RAV-GP561ATP-E/TR	RAV-GP801AT-E/TR	RAV-GP1101AT-E/TR	RAV-GP1401AT-E/TR
Indoor unit (Ceiling)			RAV-RM561CTP-E/TR	RAV-RM801CTP-E/TR	RAV-RM1101CTP-E/TR	RAV-RM1401CTP-E/TR
Cooling capacity	kW		5.0	7.1	10.0	12.5
Cooling range (min. - max.)	kW		1.2 - 5.6	1.9 - 8.0	3.1 - 12.0	3.1 - 14.0
Power input	kW	C	0.19 - 1.37 - 1.98	0.26 - 1.60 - 3.17	0.55 - 2.23 - 3.45	0.55 - 3.58 - 3.97
EER			3.65	4.44	4.48	3.49
SEER			6.76	7.95	8.23	7.58
Energy efficiency class		C	A++	A++	A++	-
Seasonal electricity consumption	kWh/a	C	259	312	425	989
Heating capacity	kW		5.6	8.0	11.2	14.0
Heating range (min. - max.)	kW		0.9 - 7.4	1.3 - 11.3	2.6 - 13.0	2.6 - 16.5
Power input (min. - rated - max.)	kW	H	0.16 - 1.39 - 2.67	0.20 - 1.80 - 3.55	0.41 - 2.38 - 3.09	0.41 - 3.59 - 4.40
COP	W/W		4.03	4.44	4.71	3.90
SCOP			4.70	5.05	4.72	4.71
Energy efficiency class		H	A++	A++	A++	-
Seasonal electricity consumption	kWh/a	H	1130	1412	2726	2852

CEILING Performance data with Super Digital Inverter Series 1 3Ph

Outdoor unit			RAV-GP1101AT8-E/TR	RAV-GP1401AT8-E/TR	RAV-GP1601AT8-E/TR
Indoor unit (Ceiling)			RAV-RM1101CTP-E/TR	RAV-RM1401CTP-E/TR	RAV-RM1601CTP-E/TR
Cooling capacity	kW		10.0	12.5	14.0
Cooling range (min. - max.)	kW		2.6 - 12.0	2.6 - 14.0	2.6 - 16.0
Power input	kW	C	0.66 - 2.56 - 3.81	0.66 - 3.68 - 4.85	0.66 - 4.60 - 6.33
EER			3.91	3.40	3.04
SEER			6.61	6.30	6.00
Energy efficiency class		C	A++	-	-
Seasonal electricity consumption	kWh/a	C	529	1190	1400
Heating capacity	kW		11.2	14.0	16.0
Heating range (min. - max.)	kW		2.4 - 14.0	2.4 - 18.0	2.4 - 19.0
Power input (min. - rated - max.)	kW	H	0.53 - 2.51 - 4.26	0.53 - 3.48 - 5.95	0.53 - 4.30 - 6.96
COP	W/W		4.46	4.02	3.72
SCOP			4.21	4.20	4.19
Energy efficiency class		H	A+	-	-
Seasonal electricity consumption	kWh/a	H	3854	3931	4003

CEILING Performance data with Digital Inverter Series 1 1Ph & 3Ph

Outdoor unit			RAV-GM401ATP-E/TR	RAV-GM561ATP-E/TR	RAV-GM801ATP-E/TR	RAV-GM901ATP-E/TR	RAV-GM1101AT(8)P-E/TR	RAV-GM1401AT(8)P-E/TR	RAV-GM1601AT(8)P-E/TR
Indoor unit (Ceiling)			RAV-RM401CTP-E/TR	RAV-RM561CTP-E/TR	RAV-RM801CTP-E/TR	RAV-RM901CTP-E/TR	RAV-RM1101CTP-E/TR	RAV-RM1401CTP-E/TR	RAV-RM1601CTP-E/TR
Cooling capacity	kW		3.6	5.0	6.9	8.0	9.5	12.1	14.0
Cooling range (min. - max.)	kW		0.9 - 4.0	1.5 - 5.6	1.5 - 8.0	1.9 - 8.8	3.0 - 11.2	3.0 - 13.2	3.0 - 16.0
Power input	kW	C	0.18 - 0.83 - 2.00	0.29 - 1.61 - 1.95	0.29 - 2.38 - 2.76	TBD	0.60 - 2.95 - 4.10	0.60 - 4.42 - 4.71	TBD
EER			4.34	3.11	2.90	3.10	3.22	2.74	TBD
SEER			6.34	5.50	5.62	6.10	5.86	5.36	TBD
Energy efficiency class		C	A++	A	A+	A++	A+	-	-
Seasonal electricity consumption	kWh/a	C	199	318	429	459	567	TBC	831
Heating capacity	kW		4.0	5.3	7.7	9.0	11.2	13.0	16.0
Heating range (min. - max.)	kW		0.8 - 5.0	1.5 - 6.3	1.5 - 9.0	1.6 - 9.9	3.0 - 13.0	3.0 - 16.0	3.0 - 18.0
Power input (min. - rated - max.)	kW	H	0.14 - 0.78 - 1.70	0.29 - 1.36 - 2.40	0.29 - 2.13 - 3.20	TBD	0.60 - 2.94 - 4.10	0.60 - 3.48 - 4.60	TBD
COP			5.13	3.90	3.62	3.40	3.81	3.73	TBD
SCOP			5.1	4.32	4.11	4.60	4.27	4.19	TBD
Energy efficiency class		H	A+++	A+	A+	A++	A+	-	-
Seasonal electricity consumption	kWh/a	H	741	908	1697	1917	2490	TBC	2732

CEILING Physical data indoor

Indoor unit			RAV-RM401CTP-E/TR	RAV-RM561CTP-E/TR	RAV-RM801CTP-E/TR	RAV-GM901CTP-E/TR	RAV-RM1101CTP-E/TR	RAV-RM1401CTP-E/TR	RAV-RM1601CTP-E/TR
Air Flow (H/L)	m³/h - l/s		900/540 - 250/150	900/540 - 250/150	1410/750 - 392/208	1600/900 - 444/250	1860/1020 - 517/283	2040/1200 - 567/333	2040/1260 - 567/350
Sound pressure level (H-M-L)	dB(A)		37-35-28	37-35-28	41-36-29	42-38-30	44-38-32	46-41-35	46-42-36
Sound power level (H)	dB(A)		52-50-43	52-50-43	56-51-44	57-53-45	59-53-47	61-56-50	61-57-51
Dimensions (HxWxD)	mm		235 x 950 x 690	235 x 950 x 690	235 x 1270 x 690	235 x 1586 x 690	235 x 1586 x 690	235 x 1586 x 690	235 x 1586 x 690
Weight	kg		23	23	29	37	37	37	37

C: cooling mode
H: heating mode
H-M-L: High - Medium - Low speed

↑ LIGHT COMMERCIAL

RM_KRTP
HIGH-WALL



Compact, quiet with an attractive design, this high-wall is suitable for every kind of project in new construction or refurbishment.

Comfort

- Auto louver mode allows optimum and uniform air distribution.

Control

- Wireless remote control with pre-set functions accessible with dedicated buttons: hi-power mode, quiet mode, comfort sleep, eco-mode.

Healthy

- Self-cleaning feature to prevent mould formation on the heat exchanger coils.

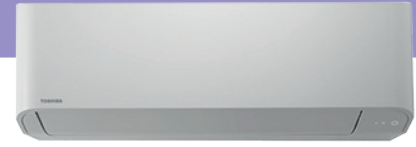

SCOP MAX



4.12

CAPACITY



2.5kW > 11.2kW

OPERATION



-20°C > +52°C

Comfort sleep function adjusts automatically the room temperature and the fan speed.

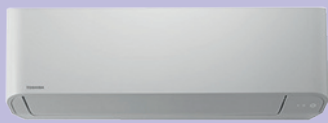

INDOOR UNITS

- RAV-RM301KRTP-E/TR
- RAV-RM401KRTP-E/TR
- RAV-RM561KRTP-E/TR
- RAV-RM801KRTP-E/TR
- RAV-GM901KRTP-E/TR
- RAV-GM1101KRTP-E/TR

SDI



OUTDOOR UNITS

- RAV-GP561ATP-E/TR
- RAV-GP801AT-E/TR
- RAV-GP1101AT(8)-E/TR

DI



- RAV-GM301ATP-E/TR
- RAV-GM401ATP-E/TR
- RAV-GM561ATP-E/TR
- RAV-GM801ATP-E/TR
- RAV-GM901ATP-E/TR
- RAV-GM1101AT(8)P-E/TR



REMOTE CONTROLS

IR included



- RBC-AMSU51E-ES(EN)
- RBC-AMTU31-E
- RBC-ASCU11-E

HIGH-WALL

HIGH-WALL Performance data with Super Digital Inverter Series 1 1Ph

Outdoor unit			RAV-GP561ATP-E/TR	RAV-GP801ATP-E/TR	RAV-GP1101ATP-E/TR
Indoor unit (High-wall)			RAV-RM561KRTP-E/TR	RAV-RM801KRTP-E/TR	RAV-GM1101KRTP-E/TR
Cooling capacity	kW		5.0	7.1	10
Cooling range (min. - max.)	kW		1.2 - 5.6	1.9 - 8.0	3.1 - 12.0
Power input	kW	C	0.19 - 1.43 - 1.98	0.26 - 2.06 - 3.17	0.55 - 2.77 - 3.90
EER			3.50	3.45	3.61
SEER			7.59	7.34	7.2
Energy efficiency class		C	A++	A++	A++
Seasonal electricity consumption	kWh/a	C	230	338	486
Heating capacity	kW		5.6	8.0	11.2
Heating range (min. - max.)	kW		0.9 - 7.3	1.3 - 11.3	2.6 - 13.0
Power input (min. - rated - max.)	kW	H	0.16 - 1.39 - 2.67	0.20 - 2.25 - 3.50	0.52 - 3.13 - 4.40
COP	W/W		4.03	3.56	3.58
SCOP			4.17	4.13	4.41
Energy efficiency class		H	A+	A+	A+
Seasonal electricity consumption	kWh/a	H	1274	1725	2920

HIGH-WALL Performance data with Super Digital Inverter Series 1 3Ph

Outdoor unit			RAV-GP1101AT8-E/TR
Indoor unit (High-wall)			RAV-GM1101KRTP-E/TR
Cooling capacity	kW		10.0
Cooling range (min. - max.)	kW		2.6 - 12.0
Power input	kW	C	2.86
EER			3.50
SEER			6.35
Energy efficiency class		C	A++
Seasonal electricity consumption	kWh/a	C	TBC
Heating capacity	kW		11.2
Heating range (min. - max.)	kW		2.4 - 13.0
Power input (min. - rated - max.)	kW	H	3.25
COP	W/W		3.45
SCOP			4.21
Energy efficiency class		H	A+
Seasonal electricity consumption	kWh/a	H	TBC

HIGH-WALL Performance data with Digital Inverter Series 1 1Ph & 3Ph

Outdoor unit			RAV-GM301ATP-E/TR	RAV-GM401ATP-E/TR	RAV-GM561ATP-E/TR	RAV-GM801ATP-E/TR	RAV-GM901ATP-E/TR	RAV-GM1101AT(8)P-E/TR
Indoor unit (High-wall)			RAV-RM301KRTP-E/TR	RAV-RM401KRTP-E/TR	RAV-RM561KRTP-E/TR	RAV-RM801KRTP-E/TR	RAV-GM901KRTP-E/TR	RAV-GM1101KRTP-E/TR
Cooling capacity	kW		2.5	3.6	5.0	6.7	8.0	9.5
Cooling range (min. - max.)	kW		0.9 - 3.0	0.9 - 4.0	1.5 - 5.6	1.5 - 8.0	1.9 - 8.8	3.0 - 11.2
Power input	kW	C	0.25 - 0.61 - 0.82	0.18 - 1.13 - 2.00	0.30 - 1.66 - 1.86	0.31 - 2.44 - 2.85	2.67	0.60 - 2.97 - 4.30
EER			4.10	3.19	3.01	2.75	3.00	3.20
SEER			6.36	6.12	6.19	5.73	6.10	6.10
Energy efficiency class		C	A++	A++	A++	A+	A++	A++
Seasonal electricity consumption	kWh/a	C	138	206	383	409	459	545
Heating capacity	kW		3.4	4.0	5.3	7.7	9.0	11.2
Heating range (min. - max.)	kW		0.8 - 4.5	0.8 - 5.0	1.5 - 6.3	1.5 - 9.0	1.6 - 9.9	3.0 - 13.0
Power input (min. - rated - max.)	kW	H	0.17 - 0.85 - 1.40	0.14 - 1.12 - 1.70	0.30 - 1.55 - 2.40	0.31 - 2.61 - 3.30	2.90	0.60 - 3.47 - 4.70
COP	W/W		4.00	3.57	3.42	2.95	3.10	3.23
SCOP			4.10	4.22	4.00	4.01	4.10	4.20
Energy efficiency class		H	A+	A+	A+	A+	A+	A+
Seasonal electricity consumption	kWh/a	H	887	895	980	1780	2151	2665

HIGH-WALL Physical data indoor

Indoor unit			RAV-RM301KRTP-E/TR	RAV-RM401KRTP-E/TR	RAV-RM561KRTP-E/TR	RAV-RM801KRTP-E/TR	RAV-GM901KRTP-E/TR	RAV-GM1101KRTP-E/TR
Air Flow (H/L)	m ³ /h - l/s	C	670/450 - 186/125	700/450 - 229/125	960/680 - 266/189	1040/680 - 289/189	1180/ 680 - 328/189	1610/1180 - 447/328
Sound pressure level (H-M-L)	dB(A)	C	40 - 34 - 29	41 - 36 - 30	42 - 39 - 35	45 - 41 - 35	47 - 41 - 35	49 - 45 - 41
Sound power level (H-M-L)	dB(A)	C	55 - 49 - 44	56 - 51 - 45	57 - 54 - 50	60 - 56 - 50	62 - 56 - 50	64 - 60 - 56
Dimensions (HxWxD)	mm		293 x 798 x 230	293 x 798 x 230	320 x 1050 x 250	320 x 1050 x 250	320 x 1050 x 250	348 x 1200 x 280
Weight	kg		10	10	14	14	14	19

C: cooling mode
H: heating mode

RM_FT
FLOOR STANDING



Toshiba floor standing unit combines important air flow, wide air diffusion and simplified installation to cool and heat large rooms.

Wide adaptability

- Broad capacity lineup from 2 to 6HP.
- Connectable in monosplit or twin mode.

Comfort

- Wide air flow to cool and heat large areas.
- Horizontal and vertical louvers for optimum air distribution.

Easy to install

- Directly positioned on the floor to simplify installation.
- Plug and play product with embedded controller.



SCOP MAX



4.41

CAPACITY



5kW > 16kW

OPERATION



-27°C > +52°C

Embedded leak detector linked to safety ventilation to facilitate the integration of the product in every kind of projects.



INDOOR UNITS

- RAV-RM561FT-EN/ES/TR
- RAV-RM801FT-EN/ES/TR
- RAV-RM1101FT-EN/ES/TR
- RAV-RM1401FT-EN/ES/TR
- RAV-RM1601FT-EN/ES/TR

SDI



OUTDOOR UNITS

- RAV-GP561ATP-E/TR
- RAV-GP801AT-E/TR
- RAV-GP1101AT(8)-E/TR
- RAV-GP1401AT(8)-E/TR
- RAV-GP1601AT8-E/TR

DI



- RAV-GM561ATP-E/TR
- RAV-GM801ATP-E/TR
- RAV-GM1101AT(8)P-E/TR
- RAV-GM1401AT(8)P-E/TR



EMBEDDED REMOTE CONTROLLER

- RBC-AMS55E-ES
- RBC-AMS55E-EN

FLOOR STANDING

FLOOR STANDING Performance data with Super Digital Inverter Series 1 1Ph

Outdoor unit	RAV-GP561ATP-E/TR		RAV-GP801AT-E/TR		RAV-GP1101AT-E/TR		RAV-GP1401AT-E/TR			
Indoor unit (High-wall)	RAV-RM561FT-EN/ES/TR		RAV-RM801FT-EN/ES/TR		RAV-RM1101FT-EN/ES/TR		RAV-RM1401FT-EN/ES/TR			
Cooling capacity	kW	5.0		7.1		10		12.5		
Cooling range (min. - max.)	kW	1.2 - 5.6		1.9 - 8.0		3.1 - 12.0		3.1 - 14.0		
Power input	kW	C	0.19 - 1.42 - 2.0		0.26 - 2.04 - 3.32		0.6 - 2.39 - 3.65		0.6 - 3.52 - 4.07	
EER			3.51		3.48		4.18		3.55	
SEER			5.75		6.24		6.67		6.1	
Energy efficiency class		C	A+		A++		A++		-	
Seasonal electricity consumption	kWh/a	C	304		398		524		1229	
Heating capacity	kW	5.6		8		11.2		14		
Heating range (min. - max.)	kW	0.9 - 7.0		1.3 - 11.3		2.6 - 13.0		2.6 - 16.5		
Power input (min. - rated - max.)	kW	H	0.16 - 1.65 - 2.80		0.2 - 2.37 - 3.75		0.42 - 2.76 - 3.85		0.42 - 3.97 - 4.61	
COP	W/W		3.39		3.38		4.06		3.53	
SCOP			4.2		4.41		4.37		4.35	
Energy efficiency class		H	A+		A+		A+		-	
Seasonal electricity consumption	kWh/a	H	1266		1618		2942		3086	

FLOOR STANDING Performance data with Super Digital Inverter Series 1 3Ph

Outdoor unit	RAV-GP1101AT8-E/TR		RAV-GP1401AT8-E/TR		RAV-GP1601AT8-E/TR			
Indoor unit (High-wall)	RAV-RM1101FT-EN/ES/TR		RAV-RM1401FT-EN/ES/TR		RAV-RM1601FT-EN/ES/TR			
Cooling capacity	kW	10		12.5		14		
Cooling range (min. - max.)	kW	2.6 - 12.0		2.6 - 14.0		2.6 - 16.0		
Power input	kW	C	0.66 - 2.46 - 4.1		0.66 - 3.61 - 4.91		0.66 - 4.39 - 6.5	
EER			4.07		3.46		3.19	
SEER			5.86		5.65		5.55	
Energy efficiency class		C	A+		-		-	
Seasonal electricity consumption	kWh/a	C	597		1326		1513	
Heating capacity	kW	11.2		14		16		
Heating range (min. - max.)	kW	2.4 - 14.0		2.4 - 18.0		2.4 - 19.0		
Power input (min. - rated - max.)	kW	H	0.53 - 2.77 - 4.8		0.53 - 3.81 - 5.95		0.53 - 4.83 - 6.96	
COP	W/W		4.04		3.67		3.31	
SCOP			4.00		4		3.96	
Energy efficiency class		H	A+		-		-	
Seasonal electricity consumption	kWh/a	H	3774		4130		4238	

FLOOR STANDING Performance data with Digital Inverter Series 1 1Ph & 3Ph

Indoor unit (High-wall)	RAV-GM561ATP-E/TR		RAV-GM801ATP-E/TR		RAV-GM1101AT(8)P-E/TR		RAV-GM1401AT(8)P-E/TR			
	RAV-RM561FT-EN/ES/TR		RAV-RM801FT-EN/ES/TR		RAV-RM1101FT-EN/ES/TR		RAV-RM1401FT-EN/ES/TR			
Cooling capacity	kW	5		6.7		9.5		12.1		
Cooling range (min. - max.)	kW	1.5 - 5.6		1.5 - 7.4		3.0 - 11.2		3.0 - 13.2		
Power input	kW	C	0.30 - 1.79 - 2.34		0.31 - 3.18 - 3.31		0.60 - 3.06 - 4.30		0.60 - 4.71 - 4.83	
EER			2.79		2.11		3.1		2.57	
SEER			5.15		4.89		5.16		4.86	
Energy efficiency class		C	A		B		A		-	
Seasonal electricity consumption	kWh/a	C	340		479		644		1492	
Heating capacity	kW	5.3		7.7		11.2		13		
Heating range (min. - max.)	kW	1.5 - 6.3		1.5 - 9.0		3.0 - 13.0		3.0 - 16.0		
Power input (min. - rated - max.)	kW	H	0.30 - 1.72 - 2.47		0.31 - 3.20 - 3.45		0.60 - 3.19 - 4.50		0.60 - 4.01 - 4.80	
COP	W/W		3.08		2.41		3.51		3.24	
SCOP			4.00		3.81		3.92		3.9	
Energy efficiency class		H	A+		A		A		-	
Seasonal electricity consumption	kWh/a	H	980		1727		2711		2727	

FLOOR STANDING Physical data indoor

Indoor unit	RAV-RM561FT-EN/ES/TR		RAV-RM801FT-EN/ES/TR		RAV-RM1101FT-EN/ES/TR		RAV-RM1401FT-EN/ES/TR		RAV-RM1601FT-EN/ES/TR	
Air Flow (H/L)	m ³ /h - l/s	C	820/600 - 228/167		930/640 - 258/178		1660/1190 - 461/331		1760/1350 - 489/375	
Sound pressure level (H-M-L)	dB(A)	C	46 - 42 - 38		50 - 45 - 41		51 - 46 - 41		53 - 48 - 45	
Sound power level (H-M-L)	dB(A)	C	60 - 56 - 52		64 - 60 - 54		65 - 61 - 55		67 - 62 - 59	
Dimensions (HxWxD)	mm		1750 x 600 x 210		1750 x 600 x 210		1750 x 600 x 390		1750 x 600 x 390	
Weight	kg		44		45		59		59	

C: cooling mode
H: heating mode

RAV-DXC STANDARD DX KIT



Enables the connection of a third-party air handling unit (with DX coil) to Toshiba LC outdoor units.

Global

- Compatible with the majority of air handling units with a DX coil fitted inside (capacity ranges from 2.5 to 27kW).
- Can operate in both heating and cooling modes, depending on end user requirements.

Control

- Control achieved using a standard Toshiba remote controller.
- Algorithm based on air suction temperature.

Easy to install

- Capacity set by DN code adjustment during installation.
- Extended 5 meters sensor leads pre-fitted to improve installation time and flexibility.
- Relay isolated inputs to prevent accidental wiring errors, damaging the PCB.



MAX AIR FLOW



Up to **5000**m³/h

CAPACITY



2.5kW > 27kW

OPERATION



-27°C > +52°C

Input/output signal available:

- Operation output,
- AC fan motor output,
- Alarm output,
- External On/Off input,
- Safety-cut output.

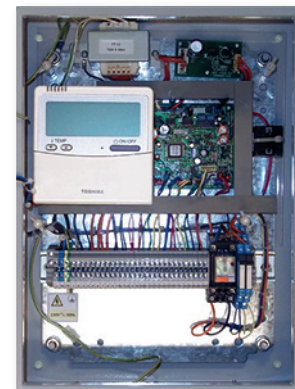

INDOOR UNITS

RAV-DXC010

SDI



OUTDOOR UNITS

RAV-GP561ATP-E
RAV-GP801AT-E
RAV-GP1101AT(8)-E
RAV-GP1401AT(8)-E
RAV-GP1601AT8-E

DI



RAV-GM301ATP-E
RAV-GM401ATP-E
RAV-GM561ATP-E
RAV-GM801ATP-E
RAV-GM901ATP-E
RAV-GM1101AT(8)P-E
RAV-GM1401AT(8)P-E
RAV-GM1601AT(8)P-E

BIG DI



RAV-GM2241AT8-E
RAV-GM2801AT8-E



REMOTE CONTROLS

RBC-AMTU31-E

STANDARD DX KIT

STANDARD DX KIT Performances

DX Controller unit	RAV-	DXC010	DXC010	DXC010	DXC010	DXC010	DXC010	DXC010	DXC010	DXC010	DXC010
Outdoor Unit		1 HP	1.5 HP	2 HP	3 HP	3.5HP	4 HP	5 HP	6 HP	8 HP	10 HP
Cooling Capacity RANGE	DI	RAV-GM301ATP-E	RAV-GM401ATP-E	RAV-GM561ATP-E	RAV-GM801ATP-E	RAV-GM901ATP-E	RAV-GM1101AT(8)P-E	RAV-GM1401AT(8)P-E	RAV-GM1601AT(8)P-E	RAV-GM2241AT8-E	RAV-GM2801AT8-E
	SDI			RAV-GP561ATP-E	RAV-GP801AT-E		RAV-GP1101AT(8)-E	RAV-GP1401AT(8)-E	RAV-GP1601AT8-E		
Cooling capacity (min-max) DI	kW	0.9 - 3.0	0.9 - 4.0	1.5 - 5.6	1.5 - 7.4	1.9 - 8.8	3.0 - 11.2	3.0 - 13.2	3.0 - 16.0	4.6 - 22.4	4.6 - 27.0
Cooling capacity (min-max) SDI	kW			1.2 - 5.6	1.9 - 8.0		3.1 - 12.0	3.1 - 14.0	2.6 - 16		
Heating capacity (min-max) DI	kW	0.8 - 4.5	0.8 - 5.0	1.5 - 6.3	1.5 - 9.0	1.6 - 9.9	3.0 - 13	3.0 - 16.0	3.0 - 18.0	4.6 - 25.0	4.6 - 31.5
Heating capacity (min-max) SDI	kW			0.9 - 8.1	1.3 - 11.3		2.6 - 13	2.6 - 16.5	2.4 - 19		
Standard air volume	m ³ /h	570	610	900	1320	1510	1600	2100	2620	3600	4200
Coil Internal Volume (min-max)	dm ³	0.5 - 0.7	0.5 - 0.7	0.8 - 1.1	1.0 - 1.4	1.3 - 1.8	1.5 - 2.1	1.7 - 2.7	2.0 - 3.2	3.0 - 4.2	3.6 - 5.4

STANDARD DX KIT Physical Data

DX Controller unit	RAV-	DXC010
Dimensions (HxWxD)	mm	400 x 300 x 150
Weight	kg	8
Operating range - Cooling coil "Air on" temp	°C	15°CWB+24°CWB
Operating range - Heating coil "Air on" temp	°C	5°CDB+28°CDB
Power supply	V-ph-Hz	220/240-1-50

C: cooling mode
H: heating mode

Cooling and heating output figures are based on calculations and "general" test data. All figures are to be taken as approximations. The properties of the third party DX Coil will have an affect on the performance of the outdoor units.

All capacity data shown is based on the following Rated Conditions:

- Cooling (Rated): Indoor air temperature 27°C db / 19°C wb, Outdoor air temperature 35°C db
- Heating (Rated): Indoor air temperature 20°C db, Outdoor air temperature 7°C db / 6°C wb.

Notes:

Cooling Mode Coil "Air On" Temp: Minimum 15°CWB (18°CDB) / Maximum 24°CWB (32°CDB)

Air temperatures flowing across the coil below this level, can in some circumstances, cause icing and freezing issues with the coil and eventually forcing the system to shut down and also be detrimental to the outdoor unit itself.

Heating Mode Coil "Air On" Temp: Minimum 15°CDB / Maximum 28°CDB

In the reserve cycle mode when the outdoor unit is producing hot gas, the coil in the AHU is effectively the condenser. Air temperatures flowing across the coil below this level, can cause over condensing of the refrigerant.

This can result in liquid being returned to the compressor which will cause a mechanical failure of the outdoor unit.

Low air temperatures will also cause the unit to use it's defrost mode more often.

Fresh Air Intake

If you wish to use Fresh Air which in outside of these Coil "Air On" limits it has to either be pre-conditioned by other equipment, or mixed with return air (or a combination of both) so that it remains inside these limits, in order to ensure reliable operation.

Automatic Mode

Please be aware that frequent mode changes could occur when using Automatic mode.

TA sensor

The TA sensor should be positioned in the return air duct. In case, it's not representative enough of the occupants area temperature, remote temperature sensor TCB -TC21LE2 should be used in the room.

RAV-DXC
0/10V DX KIT



Enables connection and control of Toshiba LC outdoor units to a third-party air handling unit (with DX coil).

Global

- Compatible with the majority of air handling units with a DX coil fitted inside (capacity ranges from 2.5 to 27kW)

Control

- Capacity control and selection mode of the Toshiba outdoor unit directly from the AHU controller through a 0/10v signal.

Easy to install

- Capacity set by DN code during installation.
- Extended 5 meters sensor leads pre-fitted to improve installation time and flexibility.



MAX AIR FLOW



Up to
5.200m³/h

CAPACITY



2.5kW > 27kW

OPERATION



-27°C > +52°C

Compatible with both LC and VRF systems.
(made possible via simple switch change on PCB)

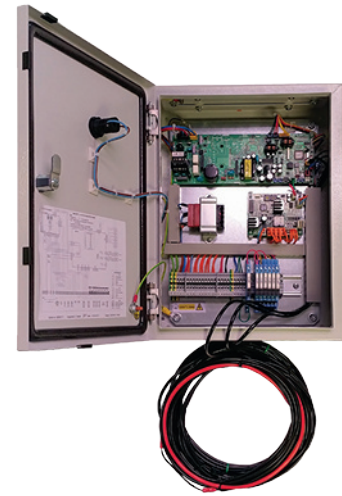

INDOOR UNITS

RAV-DXC031

SDI



OUTDOOR UNITS

RAV-GP561ATP-E
RAV-GP801AT-E
RAV-GP1101AT(8)-E
RAV-GP1401AT(8)-E
RAV-GP1601AT8-E

DI



RAV-GM301ATP-E
RAV-GM401ATP-E
RAV-GM561ATP-E
RAV-GM801ATP-E
RAV-GM901ATP-E
RAV-GM1101AT(8)P-E
RAV-GM1401AT(8)P-E
RAV-GM1601AT(8)P-E

BIG DI



RAV-GM2241AT8-E
RAV-GM2801AT8-E



REMOTE CONTROLS

RBC-AMTU31-E

0/10V DX KIT

0/10V DX KIT Performance data

DX Controller unit	RAV-	DXC010	DXC010	DXC010	DXC010	DXC010	DXC010	DXC010	DXC010	DXC010	DXC010
Outdoor Unit		1 HP	1.5 HP	2 HP	3 HP	3.5HP	4 HP	5 HP	6 HP	8 HP	10 HP
Cooling Capacity RANGE	DI	RAV-GM301ATP-E	RAV-GM401ATP-E	RAV-GM561ATP-E	RAV-GM801ATP-E	RAV-GM901ATP-E	RAV-GM1101AT(8)P-E	RAV-GM1401AT(8)P-E	RAV-GM1601AT(8)P-E	RAV-GM2241AT8-E	RAV-GM2801AT8-E
	SDI			RAV-GP561ATP-E	RAV-GP801AT-E		RAV-GP1101AT(8)-E	RAV-GP1401AT(8)-E	RAV-GP1601AT8-E		
Cooling capacity (min-max) DI	kW	0.9 - 3.0	0.9 - 4.0	1.5 - 5.6	1.5 - 7.4	1.9 - 8.8	3.0 - 11.2	3.0 - 13.2	3.0 - 16.0	4.6 - 22.4	4.6 - 27.0
Cooling capacity (min-max) SDI	kW			1.2 - 5.6	1.9 - 8.0		3.1 - 12.0	3.1 - 14.0	2.6 - 16		
Heating capacity (min-max) DI	kW	0.8 - 4.5	0.8 - 5.0	1.5 - 6.3	1.5 - 9.0	1.6 - 9.9	3.0 - 13	3.0 - 16.0	3.0 - 18.0	4.6 - 25.0	4.6 - 31.5
Heating capacity (min-max) SDI	kW			0.9 - 8.1	1.3 - 11.3		2.6 - 13	2.6 - 16.5	2.4 - 19		
Standard air volume	m ³ /h	570	610	900	1320	1510	1600	2100	2620	3600	4200
Coil Internal Volume (min-max)	dm ³	0.5 - 0.7	0.5 - 0.7	0.8 - 1.1	1.0 - 1.4	1.3 - 1.8	1.5 - 2.1	1.7 - 2.7	2.0 - 3.2	3.0 - 4.2	3.6 - 5.4

0/10V DX KIT Physical Data

LC / VRF DX Coil Controller Unit	RBC-	DXC031
Dimensions (HxWxD)	mm	400 x 300 x 150
Weight	kg	8
Standard Rating	IP	65
Operating temperature/humidity	°C / RH	5-40 / 10-90
Operating range - Cooling coil "Air on" temp	°C	15°C CWB ± 24°C CWB
Operating range - Heating coil "Air on" temp	°C	5°C CDB ± 28°C CDB
Power supply		Supplied from Outdoor unit

SDI - DI - Dig DI
TWIN +



Connect 4 indoors units on the same system to satisfy the cooling and heating requirements of larger area.

Comfort

- Precise air flow control, accurately controls the distribution of the air regardless of the room size.

Adaptability

- Twin, triple or double twin configurations.
- Compatible with every type of LC indoor units: 4-way cassette, duct, high-wall ceiling and floor standing.

Control

- One user-friendly controller for all the indoor units to simplify the control.



SCOP MAX



5.05

CAPACITY



9.5kW > 27kW

OPERATION



-27°C > +52°C

Toshiba RAV simplistic piping design allows multiple indoor units to be connected via a simple branching methodology.

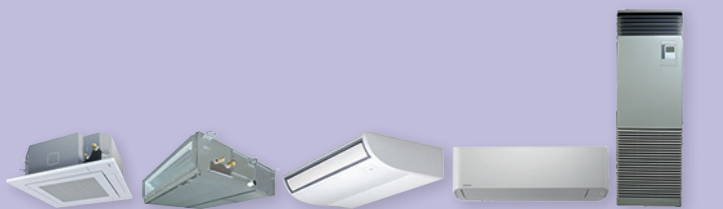
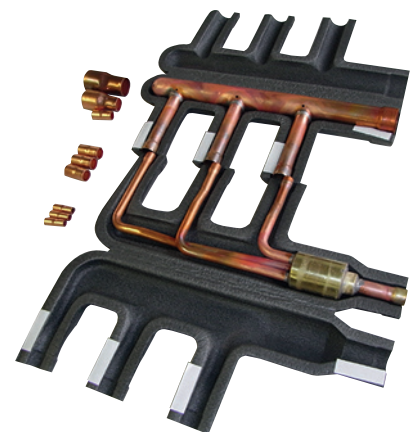

CASSETTE DUCTED CEILING HIGH-WALL FLOOR STANDING

RAV-GM_UT-E/TR RAV-RM_BTP-E/TR RAV-RM_CTP-E/TR RAV-RM_KRTP-E/TR RAV-RM_FT-EN/ES/TR
RAV-RM_UTP-E/TR RAV-RM_SDT-E/TR
RAV-RM_MUT-E/TR



OUTDOOR UNITS

RAV-GP1101AT(8)-E/TR RAV-GM1101AT(8)P-E/TR RAV-GM2241AT8-E/TR
RAV-GP1401AT(8)-E/TR RAV-GM1401AT(8)P-E/TR RAV-GM2801AT8-E/TR
RAV-GP1601AT8-E/TR RAV-GM1601AT(8)P-E/TR



REMOTE CONTROLS

RBC-AMSU51E-ES(EN)
RBC-AMTU31-E
RBC-ASCU11-E

SYSTEM OVERVIEW

TWIN SYSTEM - 2 indoor units connected

Outdoor unit

Digital Inverter
4/5 HP
or
Super Digital Inverter
3/4/5/6 HP
or
Big Digital Inverter
8/10 HP

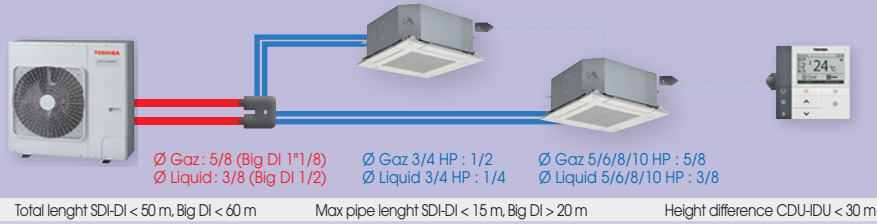

Remote

RBC-AMSU51E-ES/EN

TRIPLE SYSTEM - 3 indoor units connected

Outdoor unit

Super Digital Inverter
6 HP
or
BIG Digital Inverter
8/10 HP

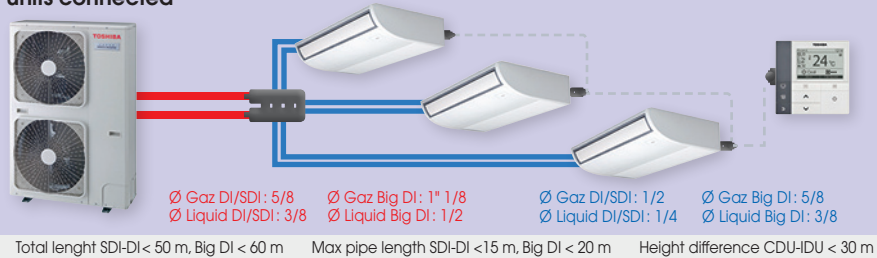

Remote

RBC-AMSU51E-ES/EN

W-TWIN SYSTEM - 4 indoor units connected

Outdoor unit

Big Digital Inverter
8/10 HP

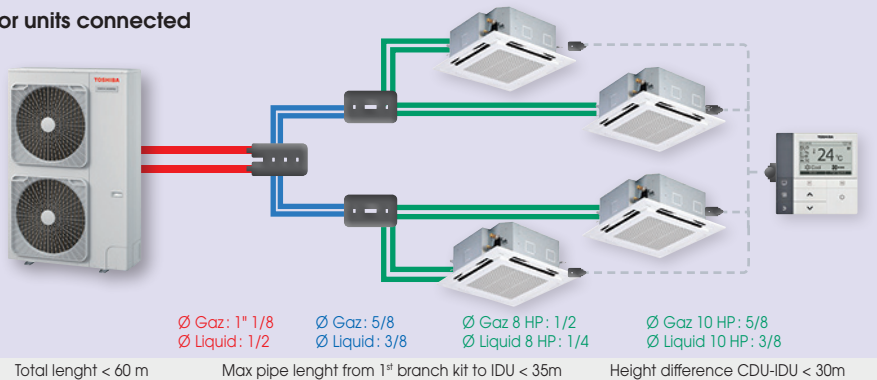

Remote

RBC-AMSU51E-ES/EN

TWIN SDI

Cooling & heating

Indoor unit model	Outdoor unit RAV-	Indoor unit RAV-	HP	Cooling capacity nin. - nominal - max kW	Heating capacity nin. - nominal - max kW	EER	SEER	COP	SCOP	Energy class
4-way cassette	GM1101AT(8)P-E	RM561UTP-E	4	3.0 - 9.5 - 11.2	3.0 - 11.2 - 13.0	3.31	5.94	3.82	4.28	A+/A+
	GM1401AT(8)P-E	RM801UTP-E	5	3.0 - 12.0 - 13.2	3.0 - 13.0 - 16.0	2.8	5.71	3.76	4.29	A+/A+
	GM1601AT(8)P-E	RM801UTP-E	6	3.0 - 14.0 - 16.0	3.0 - 16.0 - 18.0	3.12	6.3	3.61	4.35	-/-
Compact 4-way cassette	GM1101AT(8)P-E	RM561MUT-E	4	3.0 - 9.5 - 11.2	3.0 - 11.2 - 13.0	3.17	5.50	3.44	4.02	A/A+
	GM1101AT(8)P-E	RM561BTP-E	4	3.0 - 9.5 - 11.2	3.0 - 11.2 - 13.0	3.18	5.28	3.75	4.22	A/A+
	GM1401AT(8)P-E	RM801BTP-E	5	3.0 - 12.1 - 13.2	3.0 - 13.0 - 16.0	2.74	5.36	3.61	4.21	-/-
Ducted	GM1601AT(8)P-E	RM801BTP-E	6	3.0 - 14.0 - 16.0	3.0 - 16.0 - 18.0	2.73	5.30	3.41	3.47	-/-
	GM1101AT(8)P-E	RM561SDT-E	4	3.0 - 9.5 - 11.2	3.0 - 11.2 - 13.0	3.14	5.32	3.75	4.19	A/A+
	GM1101AT(8)P-E	RM561CTP-E	4	3.0 - 9.5 - 11.2	3.0 - 11.2 - 13.0	3.22	5.86	3.81	4.28	A+/A+
Ceiling	GM1401AT(8)P-E	RM801CTP-E	5	3.0 - 12.1 - 13.2	3.0 - 13.0 - 16.0	2.74	5.36	3.74	4.19	-/-
	GM1601AT(8)P-E	RM801CTP-E	6	3.0 - 14.0 - 16.0	3.0 - 16.0 - 18.0	3.01	5.90	3.47	4.1	-/-
	GM1101AT(8)P-E	RM561KRTP-E	4	3.0 - 9.5 - 11.2	3.0 - 11.2 - 13.0	3.19	5.32	3.75	4.19	A/A+
High-wall	GM1401AT(8)P-E	RM801KRTP-E	5	3.0 - 12.1 - 13.2	3.0 - 13.0 - 16.0	2.57	5.24	3.37	4.19	-/-
	GM1601AT(8)P-E	RM801KRTP-E	6	3.0 - 14.0 - 16.0	3.0 - 16.0 - 18.0	2.75	5.1	3.21	4	-/-
	GM1101AT(8)P-E	RM561FT-EN/ES	4	3.0 - 9.5 - 11.2	3.0 - 11.2 - 13.0	3.1	5.16	3.51	3.92	A/A
Floor standing	GM1401AT(8)P-E	RM801FT-EN/ES	5	3.0 - 12.1 - 13.2	3.0 - 13.0 - 16.0	2.57	4.86	3.24	3.90	-/-

TRIPLE SDI



Cooling & heating

Indoor unit model	Outdoor unit			Cooling capacity			Heating capacity			EER	SEER	COP	SCOP	Energy class
	RAV-	RAV-	HP	nin.	nominal	max	nin.	nominal	max					
	RAV-	RAV-	HP	kW			kW							
4-way cassette	GP1601AT8-E	RM561UTP-E	6	2.6	14.0	16.0	2.4	16.0	19.0	3.23	6.71	3.74	4.36	-/-
Compact 4-way cassette	GP1601AT8-E	RM561MUT-E	6	2.6	14.0	16.0	2.4	16.0	19.0	2.92	6.09	3.51	4.13	-/-
Ducted	GP1601AT8-E	RM561BTP-E	6	2.6	14.0	16.0	2.4	16.0	19.0	3.12	5.43	3.5	3.94	-/-
Slim duct	GP1601AT8-E	RM561SDT-E	6	2.6	14.0	16.0	2.4	16.0	19.0	2.91	5.98	3.5	4.07	-/-
Ceiling	GP1601AT8-E	RM561CTP-E	6	2.6	14.0	16.0	2.4	16.0	19.0	3.04	5.95	3.72	4.19	-/-
High-wall	GP1601AT8-E	RM561KRTP-E	6	2.6	14.0	16.0	2.4	14.0	19.0	3.01	5.82	3.29	4.08	-/-
Floor standing	GP1601AT8-E	RM561FT-EN/ES	6	2.6	14.0	16.0	2.4	16.0	19.0	3.19	5.55	3.31	3.96	-/-

TWIN DI



Cooling & heating

Indoor unit model	Outdoor unit			Cooling capacity			Heating capacity			EER	SEER	COP	SCOP	Energy class
	RAV-	RAV-	HP	nin.	nominal	max	nin.	nominal	max					
	RAV-	RAV-	HP	kW			kW							
4-way cassette	GM1101AT(8)P-E	RM561UTP-E	4	3.0	9.5	11.2	3.0	11.2	13.0	3.31	5.94	3.82	4.28	A+/A+
	GM1401AT(8)P-E	RM801UTP-E	5	3.0	12.0	13.2	3.0	13.0	16.0	2.8	5.71	3.76	4.29	A+/A+
	GM1601AT(8)P-E	RM801UTP-E	6	3.0	14.0	16.0	3.0	16.0	18.0	3.12	6.3	3.61	4.35	-/-
Compact 4-way cassette	GM1101AT(8)P-E	RM561MUT-E	4	3.0	9.5	11.2	3.0	11.2	13.0	3.17	5.50	3.44	4.02	A/A+
	GM1101AT(8)P-E	RM561BTP-E	4	3.0	9.5	11.2	3.0	11.2	13.0	3.18	5.28	3.75	4.22	A/A+
Ducted	GM1401AT(8)P-E	RM801BTP-E	5	3.0	12.1	13.2	3.0	13.0	16.0	2.74	5.36	3.61	4.21	-/-
	GM1601AT(8)P-E	RM801BTP-E	6	3.0	14.0	16.0	3.0	16.0	18.0	2.73	5.30	3.41	3.47	-/-
Slim duct	GM1101AT(8)P-E	RM561SDT-E	4	3.0	9.5	11.2	3.0	11.2	13.0	3.14	5.32	3.75	4.19	A/A+
	GM1101AT(8)P-E	RM561CTP-E	4	3.0	9.5	11.2	3.0	11.2	13.0	3.22	5.86	3.81	4.28	A+/A+
Ceiling	GM1401AT(8)P-E	RM801CTP-E	5	3.0	12.1	13.2	3.0	13.0	16.0	2.74	5.36	3.74	4.19	-/-
	GM1601AT(8)P-E	RM801CTP-E	6	3.0	14.0	16.0	3.0	16.0	18.0	3.01	5.90	3.47	4.1	-/-
High-wall	GM1101AT(8)P-E	RM561KRTP-E	4	3.0	9.5	11.2	3.0	11.2	13.0	3.19	5.32	3.75	4.19	A/A+
	GM1401AT(8)P-E	RM801KRTP-E	5	3.0	12.1	13.2	3.0	13.0	16.0	2.57	5.24	3.37	4.19	-/-
	GM1601AT(8)P-E	RM801KRTP-E	6	3.0	14.0	16.0	3.0	16.0	18.0	2.75	5.1	3.21	4	-/-
Floor standing	GM1101AT(8)P-E	RM561FT-EN/ES	4	3.0	9.5	11.2	3.0	11.2	13.0	3.1	5.16	3.51	3.92	A/A
	GM1401AT(8)P-E	RM801FT-EN/ES	5	3.0	12.1	13.2	3.0	13.0	16.0	2.57	4.86	3.24	3.90	-/-

TRIPLE DI



Cooling & heating

Indoor unit model	Outdoor unit			Cooling capacity			Heating capacity			EER	SEER	COP	SCOP	Energy class
	RAV-	RAV-	HP	nin.	nominal	max	nin.	nominal	max					
	RAV-	RAV-	HP	kW			kW							
4-way cassette	GM1601AT(8)P-E	RM561UTP-E	6	2.6	14.0	16.0	2.4	16.0	19.0	3.12	6.3	3.61	4.35	-/-
Compact 4-way cassette	GM1601AT(8)P-E	RM561MUT-E	6	2.6	14.0	16.0	2.4	16.0	19.0	2.82	5.1	3.41	4	-/-
Ducted	GM1601AT(8)P-E	RM561BTP-E	6	2.6	14.0	16.0	2.4	16.0	19.0	2.73	5.3	3.41	3.9	-/-
Slim duct	GM1601AT(8)P-E	RM561SDT-E	6	2.6	14.0	16.0	2.4	16.0	19.0	2.81	5.1	3.41	4	-/-
Ceiling	GM1601AT(8)P-E	RM561CTP-E	6	2.6	14.0	16.0	2.4	16.0	19.0	3.01	5.9	3.47	4.1	-/-
High-wall	GM1601AT(8)P-E	RM561KRTP-E	6	2.6	14.0	16.0	2.4	14.0	19.0	2.75	5.1	3.21	4	-/-

TWIN BIG DI



Cooling & heating

Indoor unit model	Outdoor unit	Indoor unit		Cooling capacity nin. - nominal - max kW	Heating capacity nin. - nominal - max kW	EER	SEER	COP	SCOP	Energy class
		RAV-	RAV- HP							
4-way cassette	GM2241AT8-E	RM1101UTP-E	8	4.6 - 20.0 - 22.4	4.6 - 22.4 - 25.0	3.6	6.53	4.23	4.05	-/-
	GM2801AT8-E	RM1401UTP-E	10	4.6 - 23.5 - 27.0	4.6 - 27.0 - 31.5	3	6.21	3.8	3.9	-/-
Ducted	GM2241AT8-E	RM1101BTP-E	8	4.6 - 20.0 - 22.4	4.6 - 22.4 - 25.0	3.24	5.03	4.02	3.72	-/-
	GM2801AT8-E	RM1401BTP-E	10	4.6 - 23.5 - 27.0	4.6 - 27.0 - 31.5	2.65	5	3.62	3.64	-/-
Ceiling	GM2241AT8-E	RM1101CTP-E	8	4.6 - 20.0 - 25.0	4.6 - 22.4 - 25.0	3.24	5.67	3.92	3.79	-/-
	GM2801AT8-E	RM1401CTP-E	10	4.6 - 23.5 - 27.0	4.6 - 27.0 - 31.5	2.62	5.16	3.57	3.65	-/-
Floor standing	GM2241AT8-E	RM1101FT-EN/ES	8	4.6 - 20.0 - 25.0	4.6 - 22.4 - 25.0	3.24	5.08	3.98	3.60	-/-
	GM2801AT8-E	RM1401FT-EN/ES	10	4.6 - 23.5 - 27.0	4.6 - 27.0 - 31.5	2.65	4.87	3.29	3.57	-/-

TRIPLE BIG DI



Cooling & heating

Indoor unit model	Outdoor unit	Indoor unit		Cooling capacity nin. - nominal - max kW	Heating capacity nin. - nominal - max kW	EER	SEER	COP	SCOP	Energy class
		RAV-	RAV- HP							
4-way cassette	GM2241AT8-E	RM801UTP-E	8	4.6 - 20.0 - 22.4	4.6 - 22.4 - 25.0	3.60	6.57	4.23	4.05	-/-
	GM2801AT8-E	RM801UTP-E	10	4.6 - 23.5 - 27.0	4.6 - 27.0 - 31.5	3.00	6.24	3.80	3.91	-/-
Ducted	GM2241AT8-E	RM801BTP-E	8	4.6 - 20.0 - 22.4	4.6 - 22.4 - 25.0	3.24	5.23	4.02	3.73	-/-
	GM2801AT8-E	RM801BTP-E	10	4.6 - 23.5 - 27.0	4.6 - 27.0 - 31.5	2.65	5.18	3.62	3.65	-/-
Ceiling	GM2241AT8-E	RM801CTP-E	8	4.6 - 20.0 - 25.0	4.6 - 22.4 - 25.0	3.24	5.59	3.92	3.79	-/-
	GM2801AT8-E	RM801CTP-E	10	4.6 - 23.5 - 27.0	4.6 - 27.0 - 31.5	2.62	5.16	3.57	3.65	-/-
High-wall	GM2241AT8-E	RM-801KRTP-E	8	4.6 - 20.0 - 22.4	4.6 - 22.4 - 25.0	3.00	5.58	3.66	3.76	-/-
	GM2801AT8-E	RM-801KRTP-E	10	4.6 - 23.5 - 27.0	4.6 - 27.0 - 31.5	2.55	5.30	3.53	3.63	-/-
Floor standing	GM2241AT8-E	RM801FT-EN/ES	8	4.6 - 20.0 - 22.4	4.6 - 22.4 - 25.0	3.24	5.09	3.98	3.6	-/-
	GM2801AT8-E	RM801FT-EN/ES	10	4.6 - 23.5 - 27.0	4.6 - 27.0 - 31.5	2.65	4.94	3.29	3.58	-/-

DOUBLE TWIN BIG DI



Cooling & heating

Indoor unit model	Outdoor unit	Indoor unit		Cooling capacity nin. - nominal - max kW	Heating capacity nin. - nominal - max kW	EER	SEER	COP	SCOP	Energy class
		RAV-	RAV- HP							
4-way cassette	GM2241AT8-E	RM561UTP-E	8	9.8 - 20.0 - 22.4	9.8 - 22.4 - 25.0	3.60	6.57	4.23	4.05	-/-
	GM2801AT8-E	RM801UTP-E	10	9.8 - 23.0 - 27.0	9.8 - 27.0 - 31.5	3.00	6.16	3.80	3.90	-/-
Compact 4-way cassette	GM2241AT8-E	RM561MUT-E	8	4.6 - 20.0 - 22.4	4.6 - 22.4 - 25.0	3.15	6.00	3.66	4.03	-/-
Ducted	GM2241AT8-E	RM561BTP-E	8	4.6 - 20.0 - 25.0	4.6 - 22.4 - 25.0	3.24	5.18	4.02	3.73	-/-
	GM2801AT8-E	RM801BTP-E	10	4.6 - 23.5 - 27.0	4.6 - 27.0 - 31.5	2.65	5.12	3.62	3.65	-/-
Slim duct	GM2241AT8-E	RM561SDT-E	8	4.6 - 20.0 - 22.4	4.6 - 22.4 - 25.0	3.00	5.44	3.66	3.86	-/-
	GM2241AT8-E	RM561CTP-E	8	4.6 - 20.0 - 22.4	4.6 - 22.4 - 25.0	3.24	5.68	3.92	3.79	-/-
Ceiling	GM2801AT8-E	RM801CTP-E	10	4.6 - 23.5 - 27.0	4.6 - 27.0 - 31.5	2.62	5.06	3.57	3.65	-/-
	GM2241AT8-E	RM561KRTP-E	8	4.6 - 20.0 - 22.4	4.6 - 22.4 - 25.0	3.00	5.60	3.66	3.76	-/-
High-wall	GM2801AT8-E	RM801KRTP-E	10	4.6 - 23.5 - 27.0	4.6 - 27.0 - 31.5	2.55	5.22	3.53	3.62	-/-
	GM2241AT8-E	RM561FT-EN/ES	8	4.6 - 20.0 - 25.0	4.6 - 22.4 - 25.0	3.24	5.09	3.98	3.60	-/-
Floor standing	GM2801AT8-E	RM801FT-EN/ES	10	4.6 - 23.5 - 27.0	4.6 - 27.0 - 31.5	2.65	4.87	3.29	3.57	-/-



EUROPE R410

SP_AT(8)
SUPER DIGITAL INVERTER



The Toshiba Super Digital inverter 4 series models, combine high piping lengths, with top class efficiency levels, making it the perfect solution for the majority of commercial projects and large residential applications.

Top class efficiency

- High efficiency SCOP of up to 4.58, thanks to digital hybrid inverter technology.

Wide adaptability

- Operating temperature limits allow the system to operate at extremely low temperatures in heating and in cooling if required.
- Quiet operation as low as 33db(A).

Flexible

- Can be utilised for single, twin or triple indoor applications.

Easy to maintain

- Removable corner panels for easy access.
- Self-diagnosis function.



SCOP MAX



4.58

CAPACITY



3,6kW > 16kW

OPERATION



-20°C > +46°C

Super Digital Inverter outdoor units are suitable for replacement technology enabling the re-use of existing R22 or R407C pipework.

R22
 REPLACEMENT

R410A
 >>> with TOSHIBA

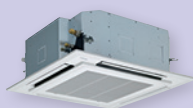

CASSETTE

RAV-RM_UTP-E/TR
 RAV-RM_MUT-E/TR



DUCTED

RAV-RM_BTP-E/E1/TR
 RAV-RM_SDT-E/TR

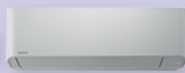

HIGH-WALL

RAV-RM_KRTP-E/TR



CEILING

RAV-RM_CTP-E/TR



FLOOR
 STANDING

RAV-RM_FT-EN/ES/TR



OUTDOOR UNITS

RAV-SP404ATP-E/TR
 RAV-SP454ATP-E/TR
 RAV-SP564ATP-E/TR



RAV-SP804ATP-E/TR



RAV-SP1104AT(8)-E1/TR1
 RAV-SP1401AT(8)-E1/TR1
 RAV-SP1604AT8-E1/TR1

SUPER DIGITAL INVERTER

SUPER DIGITAL INVERTER Physical data outdoor - 1Ph

Outdoor unit	RAV-SP404ATP-E/TR RAV-SP454ATP-E/TR RAV-SP564ATP-E/TR RAV-SP804ATP-E/TR RAV-SP1104AT-E1/TR1 RAV-SP1404AT-E1/TR1						
		1.5 HP	1.7 HP	2 HP	3 HP	4 HP	5 HP
Air flow	m ³ /h - l/s	2400 - 667	2400 - 667	2400 - 667	3000 - 833	6060 - 1683	6180 - 1716
Sound pressure level	dB(A) C	45	45	47	48	49	51
Sound power level	dB(A) C	62	62	63	64	66	68
Operating range	°C C	-15 / 43	-15 / 43	-15 / 43	-15 / 43	-15 / 43	-15 / 43
Sound pressure level	dB(A) H	47	47	48	49	50	52
Sound power level	dB(A) H	64	64	64	65	67	69
Operating range	°C H	-15 / 15	-15 / 15	-20 / 15	-20 / 15	-20 / 15	-20 / 15
Dimensions (HxWxD)	mm	550x780x290	550x780x290	550x780x290	890x900x320	1340x900x320	1340x900x320
Weight	kg	40	40	44	66	93	93
Compressor type		DC Twin Rotary	DC Twin Rotary	DC Twin Rotary	DC Twin Rotary	DC Twin Rotary	DC Twin Rotary
Flare connections							
Gas	in	1/2	1/2	1/2	5/8	5/8	5/8
Liquid	in	1/4	1/4	1/4	3/8	3/8	3/8
Minimum pipe length	m	5	5	5	5	3	3
Maximum pipe length	m	30	30	50	50	75	75
Maximum height difference	m	30	30	30	30	30	30
Chargeless pipe length	m	20	20	20	30	30	30
Refrigerant charge (R410A)	kg	1.18	1.18	1.65	2.48	3.1	3.1
Power supply	V-ph-Hz	220/240-1-50	220/240-1-50	220/240-1-50	220/240-1-50	220/240-1-50	220/240-1-50

SUPER DIGITAL INVERTER Physical data outdoor - 3Ph

Outdoor Unit	RAV-SP1104AT8-E1/TR1 RAV-SP1404AT8-E1/TR1 RAV-SP1604AT8-E1/TR1			
		4 HP	5 HP	6 HP
Air flow	m ³ /h - l/s	6060 - 1683	6180 - 1717	6180 - 1717
Sound pressure level	dB(A) C	49	51	51
Sound power level	dB(A) C	66	68	68
Operating range	°C C	-15 / 46	-15 / 46	-15 / 46
Sound pressure level	dB(A) H	50	52	53
Sound power level	dB(A) H	67	69	70
Operating range	°C H	-20 / 15	-20 / 15	-20 / 15
Dimensions (HxWxD)	mm	1340x900x320	1340x900x320	1340x900x320
Weight	kg	95	95	95
Compressor type		DC Twin Rotary	DC Twin Rotary	DC Twin Rotary
Flare connections				
Gas	in	5/8	5/8	5/8
Liquid	in	3/8	3/8	3/8
Minimum pipe length	m	3	3	3
Maximum pipe length	m	75	75	75
Maximum height difference	m	30	30	30
Chargeless pipe length	m	30	30	30
Refrigerant charge (R410A)	kg	3.1	3.1	3.1
Power supply	V-ph-Hz	380/415-3N-50	380/415-3N-50	380/415-3N-50

C: cooling mode
H: heating mode

SM_AT(8)
DIGITAL INVERTER



Toshiba Digital Inverter brings state-of-the-art inverter technology to the commercial sector, offering considerable advantages in terms of capacity, energy savings, optimised control, lower refrigerant charge and utilising one of the smallest physical dimensions and lightest range of outdoor units in the industry.

Light and compact

- With capacity outputs up to 12.8kW in a package that is only 890mm high and 69Kg in weight make this model an ideal solution, where space is limited.

Wide adaptability

- Compatible with a wide choice of indoor units: 4-way cassette, 4-way compact cassette, slim duct, standard duct, high wall, ceiling and floor standing.
- Night time operation mode reduces the noise output of the system down to as low as 33db(A).

Efficiency & energy savings

- Toshiba's inverter driven technology ensures maximum system efficiencies and performance, by matching precisely the operation of the compressor to the indoor demand load.
- Power limitation by 1% step between 50% and 100% load.

Easy to maintain

- Removable corner panels for easy access.
- Auto diagnostic function.
- Self-diagnosis function.



SCOP MAX



4.51

CAPACITY



2.5kW > 16kW

OPERATION



-15°C > +46°C

Toshiba state of the art compressor features a powerful magnetic rotor with great surface area to increase efficiency and reduce the operation noise.

- > Efficiency
- > Reliability
- > 100% Toshiba



R410A
with TOSHIBA

CE

EUROVENT
CERTIFIED
PERFORMANCE
www.europowerfactor.com

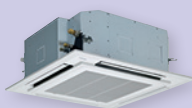

CASSETTE

RAV-RM_UTP-E/TR
RAV-RM_MUT-E/TR



DUCTED

RAV-RM_BTP-E/E1/TR
RAV-RM_SDT-E/TR

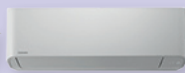

HIGH-WALL

RAV-RM_KRTP-E/TR



CEILING

RAV-RM_CTP-E/TR



FLOOR
STANDING

RAV-RM_FT-EN/ES/TR



OUTDOOR UNITS

RAV-SM304ATP-E/TR
RAV-SM404ATP-E/TR
RAV-SM564ATP-E/TR
RAV-SM804ATP-E/TR



RAV-SM1104AT(8)P-E/TR
RAV-SM1404AT(8)P-E/TR



RAV-SM1603AT-E1

DIGITAL INVERTER Physical data outdoor - 1Ph

Outdoor unit	RAV-SM304ATP-E/TR		RAV-SM404ATP-E/TR		RAV-SM564ATP-E/TR		RAV-SM804ATP-E/TR		RAV-SM1104ATP-E/TR		RAV-SM1404ATP-E/TR		RAV-SM1603AT-E1			
	1 HP		1.5 HP		2 HP		3 HP		4 HP		5 HP		6 HP			
Air flow	m ³ /h - l/s		1800 - 500		2200 - 611		2400 - 667		2700 - 750		4080 - 1133		4200 - 1167		6180 - 1717	
Sound pressure level	dB(A)	C	46		49		46		48		53		54		51	
Sound power level	dB(A)	C	61		64		63		65		70		70		68	
Operating range	°C	C	-15 / 46		-15 / 46		-15 / 46		-15 / 46		-15 / 46		-15 / 46		-15 / 43	
Sound pressure level	dB(A)	H	47		50		48		52		54		55		53	
Sound power level	dB(A)	H	62		65		65		69		71		71		70	
Operating range	°C	H	-15 / 24		-15 / 24		-15 / 15		-15 / 15		-15 / 15		-15 / 15		-15 / 15	
Dimensions (HxWxD)	mm		550x780x290		550x780x290		550x780x290		550x780x290		890x900x320		890x900x320		1340x900x320	
Weight	kg		33		39		40		44		68		68		99	
Compressor type			DC Twin Rotary		DC Twin Rotary		DC Twin Rotary		DC Twin Rotary		DC Twin Rotary		DC Twin Rotary		DC Twin Rotary	
Flare connections																
Gas	in		3/8		1/2		1/2		5/8		5/8		5/8		5/8	
Liquid	in		1/4		1/4		1/4		3/8		3/8		3/8		3/8	
Minimum pipe length	m		2		2		5		5		5		5		5	
Maximum pipe length	m		20		20		30		30		50		50		50	
Maximum height difference	m		10		10		30		30		30		30		30	
Chargeless pipe length	m		15		15		20		20		30		30		30	
Refrigerant charge (R410A)	kg		0.94		1.65		1.3		2.01		3.3		3.3		3.3	
Power supply	V-ph-Hz		220/240-1-50/60		220/240-1-50/60		220/240-1-50/60		220/240-1-50/60		220/240-1-50/60		220/240-1-50/60		220/240-1-50/60	

DIGITAL INVERTER Physical data outdoor - 3Ph

Outdoor unit	RAV-SM1104AT8P-E/TR		RAV-SM1404AT8P-E/TR			
	4 HP		5 HP			
Air flow	m ³ /h - l/s		4080 - 1133		4200 - 1167	
Sound pressure level	dB(A)	C	53		54	
Sound power level	dB(A)	C	70		70	
Operating range	°C	C	-15 / 46		-15 / 46	
Sound pressure level	dB(A)	H	54		55	
Sound power level	dB(A)	H	71		71	
Operating range	°C	H	-15 / 15		-15 / 15	
Dimensions (HxWxD)	mm		890x900x320		890x900x320	
Weight	kg		69		69	
Compressor type			DC Twin Rotary		DC Twin Rotary	
Flare connections						
Gas	in		5/8		5/8	
Liquid	in		3/8		3/8	
Minimum pipe length	m		5		5	
Maximum pipe length	m		50		50	
Maximum height difference	m		30		30	
Chargeless pipe length	m		30		30	
Refrigerant charge (R410A)	kg		3.3		3.3	
Power supply	V-ph-Hz		380/415-3-50, 380-3-60		380/415-3-50, 380-3-60	

C: cooling mode
H: heating mode

SM_AT8
BIG DIGITAL INVERTER



Big DI has been designed to provide a high capacity output from a very small foot print.

High efficiency and energy savings

- Best EER and COP in its class incorporating Toshiba's exclusive Inverter twin-rotary compressor made in Japan.
- Compliant with ERP directive lot 21.
- Top class part load efficiency.

Wide adaptability

- Allows connection of four indoor units (same type and capacity) to one outdoor unit.
- Compatible with a wide choice of indoor units: 4-way cassette, 4-way compact cassette, slim duct, standard duct, high-wall and ceiling.

Safe and reliable

- Built-in leak detection system.
- Compliant with the child finger entrapment regulation.



SCOP MAX



3.51

CAPACITY



19kW > 27kW

OPERATION



-27°C > +52°C

Installation can reach up to 100m total piping length and 30m in elevation.

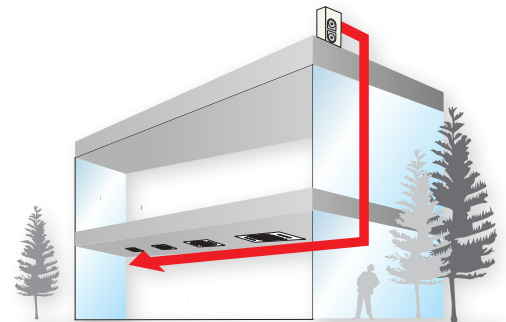

R410A
with TOSHIBA

CE



INDOOR UNITS

RAV-RM_DTP-E1/TR1



OUTDOOR UNITS

RAV-SM2246AT8-E/TR
RAV-SM2806AT8-E/TR

BIG DIGITAL INVERTER

BIG DIGITAL INVERTER Physical data outdoor - 3Ph

Outdoor Unit			RAV-SM2246AT8-E/TR 8 HP	RAV-SM2806AT8-E/TR 10 HP
Air flow	m ³ /h - l/s		9180 - 2550	10920 - 3033
Sound pressure level	dB(A)	C	58	61
Sound power level	dB(A)	C	76	78
Operating range	°C	C	-15 / 52	-15 / 52
Sound pressure level	dB(A)	H	60	63
Sound power level	dB(A)	H	76	80
Operating range	°C	H	-27 / 15	-27 / 15
Dimensions (HxWxD)	mm		1550x1100x370	1550x1100x370
Weight	kg		142	142
Compressor type			DC Twin Rotary	DC Twin Rotary
Pipe connections				
Gas	in		1 1/8	1 1/8
Liquid	in		1/2	1/2
Minimum pipe length	m		5	5
Maximum pipe length	m		100	100
Maximum height difference	m		30	30
Chargeless pipe length	m		30	30
Refrigerant charge (R410A)	kg		6.96	6.96
Power supply	V-ph-Hz		380/415-3N-50	380/415-3N-50

C: cooling mode
H: heating mode

RM_UTP
4-WAY CASSETTE



Toshiba's 4-way cassette is designed to provide uniform air distribution and total comfort; it is the ideal solution for commercial applications.

Comfort

- Possibility to choose between two louver designs, the 1st is a straight flow louver and 2nd a wide flow louver, for optimum air distribution.
- Individual setting of louver position: 3 different swing modes: standard, diagonally, opposite, turn around.
- Wide air flow in all directions.

Reliability

- Self-cleaning function and Ag-ion tip for anti-mould in drain cap.
- Built-in high-lift drain pump.

Easy to install

- Compact chassis with only 256mm height (sizes 5 and 8).
- Light-weight unit, for easy and quick installation.



SCOP MAX



4.58

CAPACITY



5kW > 16kW

OPERATION



-20°C > +46°C

Optimal air diffusion up to 4.6m ceiling height!

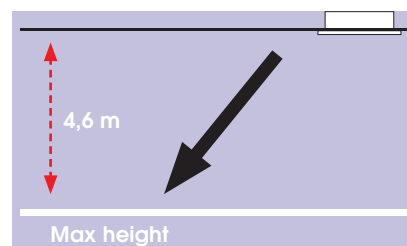

INDOOR UNITS

- RAV-RM561UTP-E/TR
- RAV-RM801UTP-E/TR
- RAV-RM1101UTP-E/TR
- RAV-RM1401UTP-E/TR
- RAV-RM1601UTP-E/TR

SDI



OUTDOOR UNITS

- RAV-SP564ATP-E/TR
- RAV-SP804ATP-E/TR
- RAV-SP1104AT(8)-E1/TR1
- RAV-SP1404AT(8)-E1/TR1
- RAV-SP1604AT8-E1/TR1

DI



- RAV-SM564ATP-E/TR
- RAV-SM804ATP-E/TR
- RAV-SM1104AT(8)P-E/TR
- RAV-SM1404AT(8)P-E/TR
- RAV-SM1603AT-E1



REMOTE CONTROLS

- RBC-AXU31U-E
- RBC-AXU31-E



- RBC-AMSU51E-ES(EN)
- RBC-AMTU31-E
- RBC-ASCU11-E

4-WAY CASSETTE

4-WAY CASSETTE Performance data with Super Digital Inverter Series 4 1ph

Outdoor unit			RAV-SP564ATP-E/TR	RAV-SP804ATP-E/TR	RAV-SP1104AT-E1/TR1	RAV-SP1404AT-E1/TR1
Indoor unit (Cassette)			RAV-RM561UTP-E/TR	RAV-RM801UTP-E/TR	RAV-RM1101UTP-E/TR	RAV-RM1401UTP-E/TR
Cooling capacity	kW		5.3	7.1	10.0	12.5
Cooling range (min. - max.)	kW		1.2 - 5.6	1.9 - 8.0	2.6 - 12.0	2.6 - 14.0
Power input (min. - rated - max.)	kW	C	0.20 - 1.47 - 1.95	0.30 - 1.86 - 2.52	0.64 - 2.21 - 3.60	0.64 - 3.16 - 4.40
EER			3.61	3.82	4.52	3.96
SEER			6.17	6.39	6.60	6.90
Energy efficiency class		C	A++	A++	A++	-
Seasonal electricity consumption	kWh/a	C	301	389	530	-
Heating capacity	kW		5.6	8.0	11.2	14.0
Heating range (min. - max.)	kW		0.9 - 8.1	1.3 - 11.3	2.4 - 13.0	2.4 - 16.5
Power input (min. - rated - max.)	kW	H	0.15 - 1.21 - 2.40	0.25 - 1.91 - 3.52	0.52 - 2.34 - 4.20	0.52 - 3.21 - 4.50
COP	W/W		4.63	4.19	4.79	4.36
SCOP			4.58	4.19	4.28	4.21
Energy efficiency class		H	A+	A+	A+	-
Seasonal electricity consumption	kWh/a	H	1649	2542	3795	-

4-WAY CASSETTE Performance data with Super Digital Inverter Series 4 3ph

Outdoor unit			RAV-SP1104AT8-E1/TR1	RAV-SP1404AT8-E1/TR1	RAV-SP1604AT8-E1/TR1
Indoor unit (4-way Cassette)			RAV-SM1101UTP-E/TR	RAV-RM1401UTP-E/TR	RAV-RM1601UTP-E/TR
Cooling capacity	kW		10.0	12.5	14.0
Cooling range (min. - max.)	kW		2.6 - 12.0	2.6 - 14.0	2.6 - 16.0
Power input (min. - rated - max.)	kW	C	0.66 - 2.37 - 3.60	0.66 - 3.46 - 4.40	0.66 - 4.49 - 5.70
EER			4.22	3.61	3.12
SEER			6.57	6.82	6.65
Energy efficiency class		C	A++	-	-
Seasonal electricity consumption	kWh/a	C	532	-	-
Heating capacity	kW		11.2	14.0	16.0
Heating range (min. - max.)	kW		2.4 - 15.6	2.4 - 18.0	2.4 - 19.0
Power input (min. - rated - max.)	kW	H	0.53 - 2.42 - 4.30	0.53 - 3.42 - 5.50	0.53 - 4.30 - 6.51
COP	W/W		4.63	4.09	3.72
SCOP			4.28	4.29	4.24
Energy efficiency class		H	A+	-	-
Seasonal electricity consumption	kWh/a	H	3795	-	-

4-WAY CASSETTE Performance data with Digital Inverter Series 4 1ph & 3ph

Outdoor unit			RAV-SM564ATP-E/TR	RAV-SM804ATP-E/TR	RAV-SM1104AT(8)P-E/TR	RAV-SM1404AT(8)P-E/TR	RAV-SM1603AT-E1
Indoor unit (4-way Cassette)			RAV-RM561UTP-E/TR	RAV-RM801UTP-E/TR	RAV-RM1101UTP-E/TR	RAV-RM1401UTP-E/TR	RAV-RM1601UTP-E/TR
Cooling capacity	kW		5.0	6.7	10.0	12.0	14.0
Cooling range (min. - max.)	kW		1.5 - 5.6	1.5 - 8.0	3.0 - 11.2	3.0 - 13.2	3.0 - 16.0
Power input (min. - rated - max.)	kW	C	0.26 - 1.56 - 1.86	0.26 - 2.22 - 2.60	0.60 - 3.02 - 4.10	0.60 - 4.29 - 4.71	0.65 - 4.49 - 5.70
EER			3.21	3.02	3.31	2.80	3.12
SEER			6.14	5.81	5.87	5.36	5.25
Energy efficiency class		C	A++	A+	A+	A	-
Seasonal electricity consumption	kWh/a	C	285	404	597	783	-
Heating capacity	kW		5.3	7.7	11.2	12.8	16.0
Heating range (min. - max.)	kW		1.5 - 6.3	1.5 - 9.0	3.0 - 13.0	3.0 - 16.0	3.0 - 18.0
Power input (min. - rated - max.)	kW	H	0.26 - 1.36 - 2.08	0.26 - 2.13 - 3.03	0.60 - 2.93 - 4.30	0.60 - 3.40 - 4.50	0.65 - 4.43 - 6.51
COP	W/W		3.90	3.62	3.82	3.76	3.61
SCOP			4.51	4.05	4.28	4.19	4.05
Energy efficiency class		H	A+	A+	A+	A+	-
Seasonal electricity consumption	kWh/a	H	1459	2349	2616	2672	-

4-WAY CASSETTE Physical data indoor

Indoor unit			RAV-RM561UTP-E/TR	RAV-RM801UTP-E/TR	RAV-RM1101UTP-E/TR	RAV-RM1401UTP-E/TR	RAV-RM1601UTP-E/TR
Air flow (H/L)	m ³ /h - l/s		1050/780 - 291/217	1230/810 - 341/225	2010/1170 - 558/325	2100/1230 - 583/341	2130/1260 - 592/350
Sound pressure level (H-M-L)	dB(A)		32-29-28	35-31-28	43-38-33	44-38-34	45-40-36
Sound power level (H-M-L)	dB(A)		47-44-43	50-46-43	58-53-48	59-53-49	60-55-51
Dimensions (HxWxD)	mm		256 × 840 × 840	256 × 840 × 840	319 × 840 × 840	319 × 840 × 840	319 × 840 × 840
Weight	kg		20	20	24	24	24
Panel dimensions (HxWxD)	mm		30×950×950	30×950×950	30×950×950	30×950×950	30×950×950
Panel weight	kg		4.2	4.2	4.2	4.2	4.2

C: cooling mode
H: heating mode

RM_MUT
COMPACT 4-WAY CASSETTE



Toshiba's 4-way cassette has been specifically designed for small commercial applications, where a compact and efficient unit is needed.

Design

- Elegant and flat appearance.
- Designed to fit within the T-bar of grid ceiling: 620mm X 620mm.

Comfort

- Individual setting of louver position: 3 different swing modes: standard, dual & cycle.
- 5 steps air flow.

Easy to install

- Compact and thin chassis, measuring just 256mm in height.
- Built-in high-lift drain pump.
- Lightweight unit, for easy and quick installation.

SCOP MAX



4.28

CAPACITY



2.5kW > 5.6kW

OPERATION



-20°C > +46°C

> Occupancy sensor switches off automatically the unit if nobody is in the room to save energy.



R410A
 >>> with TOSHIBA

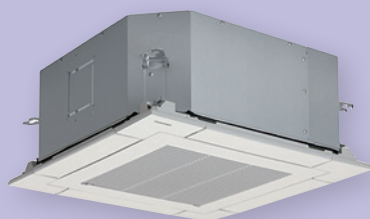

INDOOR UNITS

- RAV-RM301MUT-E/TR
- RAV-RM401MUT-E/TR
- RAV-SM457MUT-E/TR
- RAV-RM561MUT-E/TR



OUTDOOR UNITS

- RAV-SP404ATP-E/TR
- RAV-SP454ATP-E/TR
- RAV-SP564ATP-E/TR
- RAV-SM304ATP-E/TR
- RAV-SM404ATP-E/TR
- RAV-SM564ATP-E/TR



REMOTE CONTROLS

- RBC-AXU31UM-E
- RBC-AXU31-E
- RBC-AMSU51E-ES(EN)
- RBC-AMTU31-E
- RBC-ASCU11-E

COMPACT 4-WAY CASSETTE

COMPACT 4-WAY CASSETTE Performance data with Super Digital Inverter Series 4

Outdoor unit			RAV-SP404ATP-E/TR	RAV-SP454ATP-E/TR	RAV-SP564ATP-E/TR
Indoor unit (600X600 Cassette)			RAV- RM401MUT-E/TR	RAV-SM457MUT-E/TR	RAV- RM561MUT-E/TR
Cooling capacity	kW		3.6	4.0	5.0
Cooling range (min. - max.)	kW		1.5 - 4.0	1.5 - 4.5	1.2 - 5.6
Power input (min. - rated - max.)	kW	C	0.36 - 0.95 - 1.49	0.36 - 1.14 - 1.49	0.21 - 1.55 - 2.29
EER			3.79	3.51	3.23
SEER			5.87	5.61	5.94
Energy efficiency class		C	A+	A+	A+
Seasonal electricity consumption	kWh/a	C	215	250	295
Heating capacity	kW		4.0	4.5	5.6
Heating range (min. - max.)	kW		1.5 - 5.0	1.5 - 5.6	0.9 - 7.4
Power input (min. - rated - max.)	kW	H	0.36 - 0.96 - 2.20	0.36 - 1.15 - 2.30	0.17 - 1.53 - 2.37
COP	W/W		4.17	3.91	3.66
SCOP			4.49	4.49	4.42
Energy efficiency class		H	A+	A+	A+
Seasonal electricity consumption	kWh/a	H	1061	1061	1236

COMPACT 4-WAY CASSETTE Performance data with Digital Inverter Series 4

Outdoor unit			RAV-SM304ATP-E/TR	RAV-SM404ATP-E/TR	RAV-SM564ATP-E/TR
Indoor unit (600X600 Cassette)			RAV- RM301MUT-E/TR	RAV- RM401MUT-E/TR	RAV- RM561MUT-E/TR
Cooling capacity	kW		2.5	3.6	5.0
Cooling range (min. - max.)	kW		0.9 - 3.0	0.9 - 4.0	1.5 - 5.6
Power input (min. - rated - max.)	kW	C	0.25 - 0.59 - 0.82	0.18 - 0.90 - 2.00	0.30 - 1.64 - 1.86
EER			4.24	4.00	3.05
SEER			5.53	5.35	5.49
Energy efficiency class		C	A	A	A
Seasonal electricity consumption	kWh/a	C	158	235	319
Heating capacity	kW		3.4	4.0	5.3
Heating range (min. - max.)	kW		0.8 - 4.5	0.8 - 5.0	1.5 - 6.3
Power input (min. - rated - max.)	kW	H	0.17 - 0.76 - 1.40	0.14 - 0.95 - 1.70	0.30 - 1.47 - 2.40
COP	W/W		4.47	4.21	3.61
SCOP			4.60	4.34	4.27
Energy efficiency class		H	A++	A+	A+
Seasonal electricity consumption	kWh/a	H	705	1032	1279

COMPACT 4-WAY CASSETTE Physical data indoor

Indoor unit		RAV- RM301MUT-E/TR	RAV- RM401MUT-E/TR	RAV- RM561MUT-E/TR
Air Flow (H/L)	m ³ /h - l/s	640/440 - 177/122	660/468 - 183/130	798/562 - 221/156
Sound pressure level (H-M-L)	dB(A)	38 - 36 - 30	41 - 36 - 32	44 - 39 - 35
Sound power level (H)	dB(A)	53 - 51 - 45	56 - 51 - 47	59 - 54 - 50
Dimensions (HxWxD)	mm	256 x 575 x 575	256 x 575 x 575	256 x 575 x 575
Weight	kg	15	15	15
Panel dimensions (HxWxD)	mm	12 x 620 x 620	12 x 620 x 620	12 x 620 x 620
Panel weight	kg	2.5	2.5	2.5

C: cooling mode
H: heating mode
H-M-L = High - Medium - Low speed

▶ LIGHT COMMERCIAL

RM_BTP
STANDARD DUCT



Whatever the shape of the room, this flexible model ensures a uniform temperature and air distribution for optimal end user comfort.

Adaptability

- Up to 120Pa available pressure: thanks to DC fan motor.
- Flexible design, allows the inlet air configuration to be configured between the standard rear inlet design or as an alternative, from the underside of the unit. There is also a provision for a fresh air intake supply via a pre-punched knockout hole.
- Compact and thin chassis, measuring just 275mm in height.

Easy to install

- Built-in high-lift drain pump.
- PC board panel easily accessible from the side of the unit.
- Optional air discharge spigot.

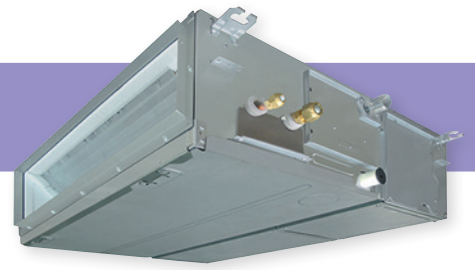

SCOP MAX



4.14

CAPACITY



3.6kW > 16kW

OPERATION



-20°C > +46°C

> Airzone compatibility: multiple individual controlled rooms with only one indoor unit.

compatible with
AIRZONE

R410A
with TOSHIBA



INDOOR UNITS

- RAV-SM406BTP-E/TR
- RAV-SM456BTP-E/TR
- RAV-RM561BTP-E/TR
- RAV-RM801BTP-E/TR
- RAV-RM1101BTP-E/TR
- RAV-RM1401BTP-E/TR
- RAV-RM1601BTP-E/TR

SDI



OUTDOOR UNITS

- RAV-SP404ATP-E/TR
- RAV-SP454ATP-E/TR
- RAV-SP564ATP-E/TR
- RAV-SP804ATP-E/TR
- RAV-SP1104AT(8)-E1/TR1
- RAV-SP1404AT(8)-E1/TR1
- RAV-SP1604AT8-E1/TR1

DI



- RAV-SM564ATP-E/TR
- RAV-SM804ATP-E/TR
- RAV-SM1104AT(8)P-E/TR
- RAV-SM1404AT(8)P-E/TR
- RAV-SM1603AT-E1



REMOTE CONTROLS

- RBC-AXU31-E
- RBC-AMSU51E-ES(EN)
- RBC-AMTU31-E
- RBC-ASCU11-E

STANDARD DUCT

STANDARD DUCT Performance data with Super Digital Inverter Series 4 1ph

Outdoor unit		RAV-SP404ATP-E/TR	RAV-SP454ATP-E/TR	RAV-SP564ATP-E/TR	RAV-SP804ATP-E/TR	RAVSP1104AT-E1/TR1	RAV-SP1404AT-E1/TR1
Indoor unit (Standard Duct)		RAV-SM406BTP-E/TR	RAV-SM456BTP-E/TR	RAV-RM561BTP-E/TR	RAV-RM801BTP-E/TR	RAV-RM1101BTP-E/TR	RAV-RM1401BTP-E/TR
Cooling capacity	kW	3.6	4.0	5.0	7.1	10.0	12.5
Cooling range (min. - max.)	kW	1.5 - 4.0	1.5 - 4.5	1.2 - 5.6	1.9 - 8.0	2.6 - 12.0	2.6 - 14.0
Power input (min. - rated - max.)	kW C	0.36 - 1.06 - 1.49	0.36 - 1.23 - 1.49	0.21 - 1.56 - 2.05	0.30 - 2.06 - 2.88	0.64 - 2.64 - 3.80	0.64 - 3.83 - 4.47
EER		3.40	3.25	3.21	3.45	3.79	3.26
SEER		5.10	5.00	4.88	5.88	5.65	5.39
Energy efficiency class	C	A	B	B	A+	A+	-
Seasonal electricity consumption	kWh/a C	247	280	359	423	619	14
Heating capacity	kW	4.0	4.5	5.6	8	11.2	14.0
Heating range (min. - max.)	kW	1.5-5.0	1.5-5.6	0.9 - 7.4	1.3 - 10.6	2.4 - 13.0	2.4 - 16.5
Power input (min. - rated - max.)	kW H	0.36 - 1.04 - 2.20	0.36 - 1.24 - 2.30	0.17 - 1.55 - 2.51	0.27 - 2.21 - 3.50	0.52 - 2.77 - 4.00	0.52 - 3.67 - 4.50
COP	W/W	3.85	3.63	3.61	3.62	4.04	3.81
SCOP		4.02	3.93	4.01	4.00	3.87	3.83
Energy efficiency class	H	A+	A	A+	A+	A	-
Seasonal electricity consumption	kWh/a H	1533	1675	1884	2448	3906	-

STANDARD DUCT Performance data with Super Digital Inverter Series 4 3ph

Outdoor unit		RAV-SP1104AT8-E1/TR1	RAV-SP1404AT8-E1/TR1	RAV-SP1604AT8-E1/TR1
Indoor unit (Standard Duct)		RAV-RM1101BTP-E/TR	RAV-RM1401BTP-E/TR	RAV-RM1601BTP-E/TR
Cooling capacity	kW	10.0	12.5	14.0
Cooling range (min. - max.)	kW	2.6 - 12.0	2.6 - 14.0	2.6 - 16.0
Power input (min. - rated - max.)	kW C	0.66 - 2.64 - 4.01	0.66 - 3.86 - 4.89	0.66 - 4.65 - 6.50
EER		3.79	3.24	3.01
SEER		5.65	5.34	5.31
Energy efficiency class	C	A+	-	-
Seasonal electricity consumption	kWh/a C	619	-	-
Heating capacity	kW	11.2	14.0	16
Heating range (min. - max.)	kW	2.40 - 15.6	2.40 - 18.0	2.4 - 19.0
Power input (min. - rated - max.)	kW H	0.53 - 2.77 - 4.42	0.53 - 3.67 - 5.71	0.53 - 4.60 - 6.96
COP	W/W	4.04	3.81	3.48
SCOP		3.87	3.94	3.93
Energy efficiency class	H	A	-	-
Seasonal electricity consumption	kWh/a H	3906	-	-

STANDARD DUCT Performance data with Digital Inverter Series 4 1ph & 3ph

Outdoor unit		RAV-SM564ATP-E/TR	RAV-SM804ATP-E/TR	RAV-SM1104AT(8)P-E/TR	RAV-SM1404AT(8)P-E/TR	RAV-SM1603AT-E1
Indoor unit (Standard Duct)		RAV-RM561BTP-E/TR	RAV-RM801BTP-E/TR	RAV-RM1101BTP-E/TR	RAV-RM1401BTP-E/TR	RAV-RM1601BTP-E/TR
Cooling capacity	kW	5.0	6.7	10.0	12.1	14.0
Cooling range (min. - max.)	kW	1.5 - 5.6	1.5 - 7.4	3.0 - 11.2	3.0 - 13.2	3.0 - 16.0
Power input (min. - rated - max.)	kW C	0.31 - 1.83 - 2.05	0.31 - 2.38 - 2.76	0.60 - 3.14 - 4.50	0.60 - 4.42 - 4.71	0.65 - 5.13 - 6.50
EER		2.73	2.82	3.18	2.74	2.73
SEER		5.1	5.1	5.1	-	4.60
Energy efficiency class	C	A	A	A	-	-
Seasonal electricity consumption	kWh/a C	365	466	696	-	-
Heating capacity	kW	5.3	7.7	11.2	12.8	16.0
Heating range (min. - max.)	kW	1.5 - 6.3	1.5 - 9.0	3.0 - 12.5	3.0 - 16.0	3.0 - 18.0
Power input (min. - rated - max.)	kW H	0.31 - 1.62 - 2.47	0.31 - 2.32 - 3.18	0.60 - 2.99 - 4.00	0.60 - 3.55 - 4.55	0.65 - 4.69 - 6.89
COP	W/W	3.27	3.32	3.75	3.61	3.41
SCOP		3.98	3.83	4.14	-	3.72
Energy efficiency class	H	A	A	A+	-	-
Seasonal electricity consumption	kWh/a H	1549	2450	2569	-	-

STANDARD DUCT Physical data indoor

Indoor unit		RAV-SM406BTP-E/TR	RAV-SM456BTP-E/TR	RAV-RM561BTP-E/TR	RAV-RM801BTP-E/TR	RAV-RM1101BTP-E/TR	RAV-RM1401BTP-E/TR	RAV-RM1601BTP-E/TR
Air flow (H/L)	m ³ /h - l/s	800/480 - 222/133	800/480 - 222/133	800/480 - 222/133	1200/720 - 333/200	2100/1260 - 583/350	2100/1260 - 583/350	2100/1260 - 583/350
Sound pressure level (H-M-L)*	dB(A)	33-29-25	33-29-25	33-29-25	34-30-26	40-36-33	40-36-33	40-36-33
Sound power level (H-M-L)*	dB(A)	48-44-40	48-44-40	48-44-40	49-45-41	55-51-48	55-51-48	55-51-48
Dimensions (HxWxD)	mm	275x700x750	275x700x750	275x700x750	275x1000x750	275x1400x750	275x1400x750	275x1400x750
Weight	kg	23	23	23	30	40	40	40
External static pressure (stand/upper limit)	Pa	30/120	30/120	30/120	30/120	50/120	50/120	50/120

C: cooling mode - H: heating mode - *bottom air inlet

▶ LIGHT COMMERCIAL

RM_SDT
SLIM DUCT



Whether installed in a ceiling void or in a false ceiling, Toshiba's slim duct offers the ultimate technology, with exceptional energy savings, high performance and easy installation.

Adaptability

- Up to 50Pa available pressure with four steps set up.
- Easy to combine with different types of air diffusers.
- Flexible design, allows the inlet air configuration to be configured between the standard rear inlet design or as an alternative, from the underside of the unit. There is also a provision for a fresh air intake supply via a pre-punched knockout hole.

Easy to install

- Slimline design, with a height of just 21cm and a weight of 22kg, gives increased flexibility when designing and installing the system.
- Natural drain discharge or built-in drain pump to manage condensates.

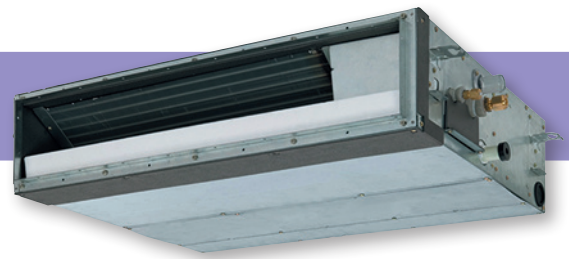

SCOP MAX



4.48

CAPACITY



2.5kW > 5.6kW

OPERATION



-20°C > +46°C

> Cleaned prefilter included compatible with rear or underside air suction.

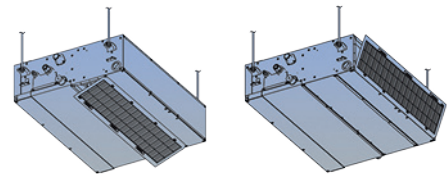

R410A
with TOSHIBA

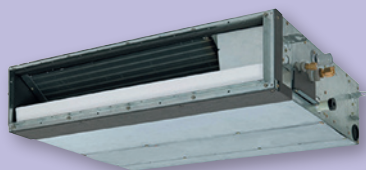

INDOOR UNITS

RAV-RM301SDT-E/TR
RAV-RM401SDT-E/TR
RAV-SM454SDT-E/TR
RAV-RM561SDT-E/TR

SDI



OUTDOOR UNITS

RAV-SP404ATP-E/TR
RAV-SP454ATP-E/TR
RAV-SP564ATP-E/TR

DI



RAV-SM304ATP-E/TR
RAV-SM404ATP-E/TR
RAV-SM564ATP-E/TR



REMOTE CONTROLS

RBC-AXU31-E
RBC-AMSU51E-ES(EN)
RBC-AMTU31-E
RBC-ASCU11-E

SLIM DUCT

SLIM DUCT Performance data with Super Digital Inverter Series 4

Outdoor unit			RAV-SP404ATP-E/TR	RAV-SP454ATP-E/TR	RAV-SP564ATP-E/TR
Indoor unit (Slim duct)			RAV-RM401SDT-E/TR	RAV-SM454SDT-E/TR	RAV-RM561SDT-E/TR
Cooling capacity	kW		3.6	4.0	5.0
Cooling range (min. - max.)	kW		1.5 - 4.0	1.5 - 4.5	1.2 - 5.6
Power input (min. - rated - max.)	kW	C	0.37 - 1.03 - 1.25	0.37 - 1.2 - 1.49	0.21 - 1.56 - 2.29
EER			3.50	3.33	3.21
SEER			5.11	5.01	5.1
Energy efficiency class		C	A	B	A
Seasonal electricity consumption	kWh/a	C	246	280	343
Heating capacity	kW		4.0	4.5	5.6
Heating range (min. - max.)	kW		1.5 - 5.0	1.5 - 5.6	0.9 - 7.4
Power input (min. - rated - max.)	kW	H	0.37 - 1.00 - 2.20	0.37 - 1.15 - 2.30	0.17 - 1.44 - 2.37
COP	W/W		4.00	3.91	3.89
SCOP			3.9	3.9	3.83
Energy efficiency class		H	A	A	A
Seasonal electricity consumption	kWh/a	H	1364	1364	1975

SLIM DUCT Performance data with Digital Inverter Series 4

Outdoor unit			RAV-SM304ATP-E/TR	RAV-SM404ATP-E/TR	RAV-SM564ATP-E/TR
Indoor unit (Slim duct)			RAV-RM301SDT-E/TR	RAV-RM401SDT-E/TR	RAV-RM561SDT-E/TR
Cooling capacity	kW		2.5	3.6	5.0
Cooling range (min. - max.)	kW		0.9 - 3.0	0.9 - 4.0	1.5 - 5.6
Power input (min. - rated - max.)	kW	C	0.25 - 0.56 - 0.82	0.18 - 0.93 - 2.00	0.32 - 1.91 - 2.75
EER			4.46	3.87	2.62
SEER			6.10	5.55	5.06
Energy efficiency class		C	A++	A	B
Seasonal electricity consumption	kWh/a	C	143	227	346
Heating capacity	kW		3.4	4.0	5.3
Heating range (min. - max.)	kW		0.8 - 4.5	0.8 - 5.0	1.5 - 6.3
Power input (min. - rated - max.)	kW	H	0.17 - 0.86 - 1.40	0.14 - 0.97 - 1.70	0.32 - 1.50 - 2.40
COP	W/W		3.95	4.12	3.53
SCOP			4.48	3.88	4.06
Energy efficiency class		H	A+	A	A+
Seasonal electricity consumption	kWh/a	H	907	1337	1517

SLIM DUCT Physical data indoor

Indoor unit			RAV-RM301SDT-E/TR	RAV-RM401SDT-E/TR	RAV-SM454SDT-E/TR	RAV-RM561SDT-E/TR
Air flow (H/L)	m ³ /h - l/s		690/500 - 192/139	690/522 - 192/145	690/522 - 192/145	780/582 - 217/162
Sound pressure level (H-M-L)*	dB(A)		39-36-33	39-36-33	39-36-33	45-40-36
Sound power level (H)*	dB(A)		54-51-48	54-51-48	54-51-48	60-55-51
Dimensions (HxWxD)	mm		210x845x645	210x845x645	210x845x645	210x845x645
Weight	kg		22	22	22	22
External static pressure (stand/upper limit)	Pa		10/50	10/50	10/50	10/50

C: cooling mode
H: heating mode
*bottom air inlet

RM_CTP
CEILING



The simple, yet elegant design helps to create a pleasant and relaxing environment, quickly conditioning the room air to the desired temperature.

Comfort

- Automatic louvre control for all year round comfort and efficiency.
- Low noise levels, thanks to high diameter fan and DC motor.

Reliability

- Self-cleaning function, enables the air flow to remain constant and fresh and reduces the frequency of service visits.

Easy to install and to maintain

- This design, represents the best possible solution, where there is a lack of space or absence of a ceiling void.

Adaptability

- Anti-bacterial drain point available as an option.
- Connecting kit available as an option for external I/O without local relay preparation.



SCOP MAX



4.98

CAPACITY



3.6kW > 16kW

OPERATION



-20°C > +46°C

The airflow angle is automatically set to the most suitable setting according to the cooling or heating needs.

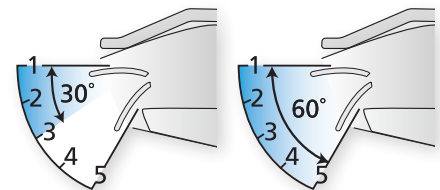

INDOOR UNITS

- RAV-RM401CTP-E/TR
- RAV-RM561CTP-E/TR
- RAV-RM801CTP-E/TR
- RAV-RM1101CTP-E/TR
- RAV-RM1401CTP-E/TR

SDI



DI



OUTDOOR UNITS

- RAV-SP564ATP-E/TR
- RAV-SP804ATP-E/TR
- RAV-SP1104AT(8)-E1/TR1
- RAV-SP1404AT(8)-E1/TR1
- RAV-SP1608AT8-E1/TR1
- RAV-SM404ATP-E/TR
- RAV-SM564ATP-E/TR
- RAV-SM804ATP-E/TR
- RAV-SM1104AT(8)P-E/TR
- RAV-SM1404AT(8)P-E/TR
- RAV-SM1603AT-E1



REMOTE CONTROLS

- RBC-AXU31UC-E
- RBC-AXU31-E



- RBC-AMSU51E-ES(EN)
- RBC-AMTU31-E
- RBC-ASCU11-E

CEILING

CEILING Performance data with Super Digital Inverter Series 4 1ph

Outdoor unit	RAV-SP564ATP-E/TR		RAV-SP804ATP-E/TR		RAV-SP1104AT-E1/TR1		RAV-SP1404AT-E1/TR1			
Indoor unit (Ceiling)	RAV-RM561CTP-E/TR		RAV-RM801CTP-E/TR		RAV-RM1101CTP-E/TR		RAV-RM1401CTP-E/TR			
Cooling capacity	kW	5,0		7,1		10,0		12,5		
Cooling range (min. - max.)	kW	1,2 - 5,6		1,9 - 8,0		2,6 - 12,0		2,6 - 14,0		
Power input	kW	C	0.21-1.37-2.26		0.30-1.86-2.88		0.64-2.45-3.70		0.64-3.90-4.47	
EER			3.65		3.82		4.08		3.21	
SEER			5.45		6.21		6.18		6.24	
Energy efficiency class		C	A		A++		A++		-	
Seasonal electricity consumption	kWh/a	C	321		400		567		-	
Heating capacity	kW	5,6		8,0		11,2		14,0		
Heating range (min. - max.)	kW		0,9 - 7,4		1,3 - 10,6		2,4 - 13,0		2,4 - 16,5	
Power input (min. - rated - max.)	kW	H	0.17-1.28-2.34		0.27-1.92-3.50		0.52-2.39-4.00		0.52-3.62-4.60	
COP	W/W		4.38		4.17		4.69		3.87	
SCOP			4.28		4.10		4.27		4.2	
Energy efficiency class		H	A+		A+		A+		-	
Seasonal electricity consumption	kWh/a	H	1765		2596		3801		-	

CEILING Performance data with Super Digital Inverter Series 4 3ph

Outdoor unit	RAV-SP1104AT8-E1/TR1		RAV-SP1404AT8-E1/TR1		RAV-SP1604AT8-E1/TR1			
Indoor unit (Ceiling)	RAV-RM1101CTP-E/TR		RAV-RM1401CTP-E/TR		RAV-RM1601CTP-E/TR			
Cooling capacity	kW	10,0		12,5		14,0		
Cooling range (min. - max.)	kW	2,6 - 12,0		2,6 - 14,0		2,6 - 16,0		
Power input	kW	C	0.66 - 2.37 - 3.81		0.66 - 3.72 - 4.85		0.66 - 4.50 - 6.33	
EER			4.22		3.36		3.11	
SEER			6.35		6.17		6.08	
Energy efficiency class		C	A++		-		-	
Seasonal electricity consumption	kWh/a	C	551		-		-	
Heating capacity	kW	11,2		14,0		16,0		
Heating range (min. - max.)	kW		2,4-14,0		2,4-18,0		2,4-19,0	
Power input (min. - rated - max.)	kW	H	0.53-2.53-4.26		0.53-3.56-5.95		0.53-4.31-6.96	
COP			4.43		3.93		3.71	
SCOP			4.41		4.20		4.19	
Energy efficiency class		H	A+		-		-	
Seasonal electricity consumption	kWh/a	H	3685		-		-	

CEILING Performance data with Digital Inverter Series 4 1ph & 3ph

Outdoor unit	RAV-SM404ATP-E/TR		RAV-SM564ATP-E/TR		RAV-SM804ATP-E/TR		RAV-SM1104AT(8)P-E/TR		RAV-SM1404AT(8)P-E/TR		RAV-SM1603AT-E1			
Indoor unit (Ceiling)	RAV-RM401CTP-E/TR		RAV-RM561CTP-E/TR		RAV-RM801CTP-E/TR		RAV-RM1101CTP-E/TR		RAV-RM1401CTP-E/TR		RAV-RM1601CTP-E/TR			
Cooling capacity	kW	3,6		5,0		6,9		10,0		12,1		14,0		
Cooling range (min. - max.)	kW	0,9 - 4,0		1,5 - 5,6		1,5 - 7,4		3,0 - 11,2		3,0 - 13,2		3,0 - 16,0		
Power input	kW	C	0.18 - 0.83 - 2.00		0.29-1.61-1.95		0.29-2.38-2.76		0.60-3.11-4.10		0.60-4.42-4.71		0.65-4.65-6.33	
EER			4.34		3.11		2.90		3.22		2.74		3.01	
SEER			5.96		5.41		5.62		5.79		-		5.02	
Energy efficiency class		C	A+		A		A+		A+		-		-	
Seasonal electricity consumption	kWh/a	C	211		324		429		604		-		-	
Heating capacity	kW	4,0		5,3		7,7		11,2		12,8		16,0		
Heating range (min. - max.)	kW		0,8 - 5,0		1,5 - 6,3		1,5 - 9,0		3,0 - 12,5		3,0 - 16,0		3,0 - 18,0	
Power input (min. - rated - max.)	kW	H	0.14 - 0.78 - 1.70		0.29-1.36-2.40		0.29-2.13-3.20		0.60-2.94-4.10		0.60-3.43-4.60		0.65-4.61-6.89	
COP			5.13		3.90		3.62		3.81		3.73		3.47	
SCOP			4.98		4.21		4.01		4.27		-		3.95	
Energy efficiency class		H	A++		A+		A+		A+		-		-	
Seasonal electricity consumption	kWh/a	H	1125		1562		2372		2489		-		-	

CEILING Physical data indoor

Indoor unit	RAV-RM401CTP-E/TR		RAV-RM561CTP-E/TR		RAV-RM801CTP-E/TR		RAV-RM1101CTP-E/TR		RAV-RM1401CTP-E/TR		RAV-RM1601CTP-E/TR		
Air flow (H/L)	m³/h - l/s	900/540 - 250/150		900/540 - 250/150		1410/750 - 392/208		1860/1020 - 517/283		2040/1200 - 567/333		2040/1260 - 567/350	
Sound pressure level (H-M-L)	dB(A)	37-35-28		37-35-28		41-36-29		44-38-32		46-41-35		46-42-36	
Sound power level (H-M-L)	dB(A)	52-50-43		52-50-43		56-51-44		59-53-47		61-56-50		61-57-51	
Dimensions (HxWxD)	mm	235x950x690		235x950x690		235x1270x690		235x1586x690		235x1586x690		235x1586x690	
Weight	kg	23		23		29		37		37		37	

C: cooling mode
H: heating mode
H-M-L = High - Medium - Low speed

RM_KRTP
HIGH-WALL



Compact, quiet with an attractive design, this high-wall is suitable for every kind of project in new construction or refurbishment.

Comfort

- Auto louver mode allows optimum and uniform air distribution.

Control

- Wireless remote control with pre-set functions accessible with dedicated buttons: hi-power mode, quiet mode, comfort sleep, eco-mode.

Healthy

- Self-cleaning feature to prevent mould formation on the heat exchanger coils.

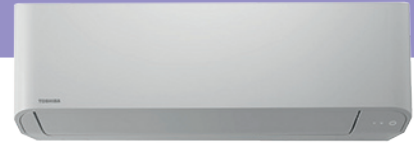

SCOP MAX



4.12

CAPACITY



2.5kW > 8kW

OPERATION



-20°C > +46°C

Comfort sleep function adjusts automatically the room temperature and the fan speed.



R410A
with TOSHIBA

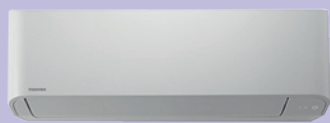

INDOOR UNITS

RAV-RM301KRTP-E/TR
RAV-RM401KRTP-E/TR
RAV-RM561KRTP-E/TR
RAV-RM801KRTP-E/TR

SDI



OUTDOOR UNITS

RAV-SP564ATP-E/TR
RAV-SP804ATP-E/TR

DI



RAV-SM304ATP-E/TR
RAV-SM404ATP-E/TR
RAV-SM564ATP-E/TR
RAV-SM804ATP-E/TR



REMOTE CONTROLS

IR included



RBC-AMSU51E-ES(EN)
RBC-AMTU31-E
RBC-ASCU11-E

HIGH-WALL

HIGH-WALL Performance data with Super Digital Inverter Series 4

Outdoor unit			RAV-SP564ATP-E/TR	RAV-SP804ATP-E/TR
Indoor unit (High-wall)			RAV-RM561KRTP-E/TR	RAV-RM801KRTP-E/TR
Cooling capacity	kW		5.0	7.1
Cooling range (min. - max.)	kW		1.2 - 5.6	1.9 - 8.0
Power input	kW	C	0.21 - 1.44 - 2.05	0.30 - 2.21 - 2.88
EER			3.47	3.21
SEER			5.82	5.88
Energy efficiency class		C	A+	A+
Seasonal electricity consumption	kWh/a	C	300	422
Heating capacity	kW		5.6	8.0
Heating range (min. - max.)	kW		0.9 - 7.3	1.3 - 10.6
Power input (min. - rated - max.)	kW	H	0.17 - 1.50 - 2.57	0.27 - 2.34 - 3.87
COP	W/W		3.73	3.42
SCOP			4.01	3.87
Energy efficiency class		H	A+	A
Seasonal electricity consumption	kWh/a	H	2027	2534

HIGH-WALL Performance data with Digital Inverter Series 4

Outdoor unit			RAV-SM304ATP-E/TR	RAV-SM401ATP-E/TR	RAV-SM564ATP-E/TR	RAV-SM804ATP-E/TR
Indoor unit (High-wall)			RAV-RM301KRTP-E/TR	RAV-RM401KRTP-E/TR	RAV-RM561KRTP-E/TR	RAV-RM801KRTP-E/TR
Cooling capacity	kW		2.5	3.6	5.0	6.7
Cooling range (min. - max.)	kW		0.9 - 3.0	0.9 - 4.0	1.5 - 5.6	1.5 - 7.0
Power input	kW	C	0.25 - 0.61 - 0.82	0.18 - 1.13 - 2.00	0.30 - 1.66 - 1.86	0.31 - 2.44 - 2.85
EER			4.10	3.19	3.01	2.75
SEER			5.9	5.40	5.77	5.62
Energy efficiency class		C	A+	A	A+	A+
Seasonal electricity consumption	kWh/a	C	148	233	304	417
Heating capacity	kW		3.0	3.6	5.3	7.7
Heating range (min. - max.)	kW		0.8 - 4.5	0.8 - 5.0	1.5 - 6.3	1.5 - 9.0
Power input (min. - rated - max.)	kW	H	0.17 - 0.85 - 1.40	0.14 - 1.12 - 1.70	0.30 - 1.55 - 2.40	0.31 - 2.61 - 3.30
COP	W/W		4.00	3.57	3.42	2.95
SCOP			4.00	4.12	4.00	4.01
Energy efficiency class		H	A+	A+	A+	A+
Seasonal electricity consumption	kWh/a	H	1049	1223	1539	2198

HIGH-WALL Physical data indoor

Indoor unit			RAV-RM301KRTP-E/TR	RAV-RM401KRTP-E/TR	RAV-RM561KRTP-E/TR	RAV-RM801KRTP-E/TR
Air flow (H/L)	m ³ /h - l/s	C	670/450 - 186/125	700/450 - 229/125	960/680 - 266/189	1040/680 - 289/189
Sound pressure level (H-M-L)	dB(A)	C	40-34-29	41-36-30	42-39-35	45-41-35
Sound power level (H-M-L)	dB(A)	C	55-49-44	56-51-45	57-54-50	60-56-50
Dimensions (HxWxD)	mm		293 x 798 x 230	293 x 798 x 230	320 x 1050 x 250	320 x 1050 x 250
Weight	kg		10	10	14	14
Air flow (H/L)	m ³ /h - l/s	H	670/450 - 186/125	690/350 - 192/97	570/360 - 158/100	690/350 - 192/97
Sound pressure level (H-M-L)	dB(A)	H	40-34-29	41-36-30	42-39-35	45-41-35
Sound power level (H-M-L)	dB(A)	H	55-49-44	56-51-45	57-54-50	60-56-50

C: cooling mode
H: heating mode

RM_FT
FLOOR STANDING



Toshiba floor standing unit combines important air flow, wide air diffusion and simplified installation to cool and heat large rooms.

Wide adaptability

- Broad capacity lineup from 2 to 6HP.
- Connectable in monosplit or twin mode.

Comfort

- Wide air flow to cool and heat large areas.
- Horizontal and vertical louvers for optimum air distribution.

Easy to install

- Directly positioned on the floor to simplify installation.
- Plug and play product with embedded controller.



SCOP MAX



3.97

CAPACITY



5kW > 16kW

OPERATION



-20°C > +46°C

Embedded air suction filters.

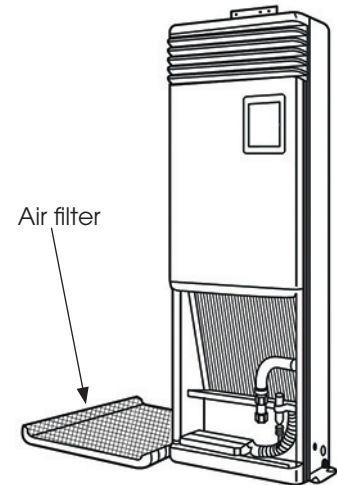

R410A
with TOSHIBA



INDOOR UNITS

RAV-RM561FT-EN/ES/TR
RAV-RM801FT-EN/ES/TR
RAV-RM1101FT-EN/ES/TR
RAV-RM1401FT-EN/ES/TR
RAV-RM1601FT-EN/ES/TR

SDI



OUTDOOR UNITS

RAV-SP564ATP-E/TR
RAV-SP804ATP-E/TR
RAV-SP1104AT(8)-E1/TR1
RAV-SP1401AT(8)-E1/TR1
RAV-SP1601AT8-E1/TR1

DI



RAV-SM564ATP-E/TR
RAV-SM804ATP-E/TR
RAV-SM1104AT(8)P-E/TR
RAV-SM1404AT(8)P-E/TR
RAV-SM1603AT-E1



EMBEDDED REMOTE CONTROLLER

RBC-AMS55E-ES
RBC-AMS55E-EN

FLOOR STANDING

FLOOR STANDING Performance data with Super Digital Inverter Series 4 1Ph

Outdoor unit	RAV-SP564ATP-E/TR		RAV-SP804ATP-E/TR		RAV-SP1104AT-E1/TR1		RAV-SP1404AT-E1/TR1			
Indoor unit (Ceiling)	RAV-RM561FT-EN/ES/TR		RAV-RM801FT-EN/ES/TR		RAV-RM1101FT-EN/ES/TR		RAV-RM1401FT-EN/ES/TR			
Cooling capacity	kW	5		7.1		10		12.5		
Cooling range (min. - max.)	kW	1.2 - 5.6		1.9 - 8.0		2.6 - 12.0		2.6 - 14.0		
Power input	kW	C	0.21 - 1.81 - 2.35		0.3 - 2.46 - 2.98		0.64 - 2.72 - 4.06		0.64 - 4.13 - 4.6	
EER			2.76		2.89		3.68		3.03	
SEER			5.15		5.10		5.86		5.42	
Energy efficiency class		C	A		A		A+			
Seasonal electricity consumption	kWh/a	C	340		487		597		1382	
Heating capacity	kW	6		8		11		14		
Heating range (min. - max.)	kW	0.9 - 7.4		1.3 - 10.6		2.4 - 13.0		2.4 - 16.5		
Power input (min. - rated - max.)	kW	H	0.17 - 1.8 - 2.6		0.27 - 2.7 - 3.87		0.52 - 3 - 4.36		0.52 - 4.29 - 4.8	
COP	W/W		3.11		2.96		3.73		3.26	
SCOP			3.95		3.9		3.95		3.97	
Energy efficiency class		H	A		A		A			
Seasonal electricity consumption	kWh/a	H	1772		2512		4108		4089	

FLOOR STANDING Performance data with Super Digital Inverter Series 4 3Ph

Outdoor unit	RAV-SP1104AT8-E1/TR1		RAV-SP1404AT8-E1/TR1		RAV-SP1604AT8-E1/TR1			
Indoor unit (Ceiling)	RAV-RM1101FT-EN/ES/TR		RAV-RM1401FT-EN/ES/TR		RAV-RM1601FT-EN/ES/TR			
Cooling capacity	kW	10		12.5		14		
Cooling range (min. - max.)	kW	2.6 - 12.0		2.6 - 14.0		2.6 - 16.0		
Power input	kW	C	0.66 - 2.72 - 4.1		0.66 - 3.93 - 4.91		0.66 - 4.96 - 6.5	
EER			3.68		3.18		2.82	
SEER			5.71		5.36		5.33	
Energy efficiency class		C	A+		-		-	
Seasonal electricity consumption	kWh/a	C	613		1398		1575	
Heating capacity	kW	11.2		14		16		
Heating range (min. - max.)	kW	2.4 - 14.0		2.4 - 18.0		2.4 - 19.0		
Power input (min. - rated - max.)	kW	H	0.53 - 3 - 4.8		0.53 - 4.29 - 5.95		0.53 - 5.03 - 6.96	
COP	W/W		3.73		3.26		3.18	
SCOP			3.95		3.95		3.92	
Energy efficiency class		H	A		-		-	
Seasonal electricity consumption	kWh/a	H	4108		4173		4278	

FLOOR STANDING Performance data with Digital Inverter Series 4 1Ph & 3Ph

Outdoor unit	RAV-SM564ATP-E/TR		RAV-SM804ATP-E/TR		RAV-SM1104AT(8)P-E/TR		RAV-SM1404AT(8)P-E/TR		RAV-SM1603AT-E1			
Indoor unit (Ceiling)	RAV-RM561FT-EN/ES/TR		RAV-RM801FT-EN/ES/TR		RAV-RM1101FT-EN/ES/TR		RAV-RM1401FT-EN/ES/TR		RAV-RM1601FT-EN/ES/TR			
Cooling capacity	kW	5		6.7		10		12.1		14		
Cooling range (min. - max.)	kW	1.5 - 5.6		1.5 - 7.4		3.0 - 11.2		3.0 - 13.2		3.0 - 16.0		
Power input	kW	C	0.30 - 1.79 - 2.34		0.31 - 3.18 - 3.31		0.60 - 3.23 - 4.50		0.60 - 4.71 - 4.83		0.65 - 5.07 - 6.50	
EER			2.79		2.11		3.1		2.57		2.76	
SEER			5.10		4.89		5.10		4.8		4.6	
Energy efficiency class		C	A		B		A		-		-	
Seasonal electricity consumption	kWh/a	C	343		479		686		1512		1825	
Heating capacity	kW	5.3		7.7		11.2		12.8		16		
Heating range (min. - max.)	kW	1.5 - 6.3		1.5 - 9.0		3.0 - 12.5		3.0 - 16.0		3.0 - 18.0		
Power input (min. - rated - max.)	kW	H	0.30 - 1.72 - 2.47		0.31 - 3.2 - 3.45		0.60 - 3.19 - 4.50		0.60 - 3.95 - 4.80		0.65 - 5.13 - 6.89	
COP			3.08		2.41		3.51		3.24		3.12	
SCOP			3.90		3.81		3.92		3.9		3.64	
Energy efficiency class		H	A		A		A		-		-	
Seasonal electricity consumption	kWh/a	H	1434		1727		2711		2727		3846	

FLOOR STANDING Physical data indoor

Indoor unit		RAV-RM561FT-EN/ES/TR	RAV-RM801FT-EN/ES/TR	RAV-RM1101FT-EN/ES/TR	RAV-RM1401FT-EN/ES/TR	RAV-RM1601FT-EN/ES/TR
Air Flow (H/L)	m ³ /h - l/s	820/600 - 228/167	930/640 - 258/178	1660/1190 - 461/331	1760/1350 - 489/375	1760/1350 - 489/375
Sound pressure level (H-M-L)*	dB(A)	46-42-38	50-45-41	51-46-41	53-48-45	53-48-45
Sound power level (H-M-L)*	dB(A)	60-56-52	64-60-54	65-61-55	67-62-59	67-62-59
Dimensions (HxWxD)	mm	1750 x 600 x 210	1750 x 600 x 210	1750 x 600 x 390	1750 x 600 x 390	1750 x 600 x 390
Weight	kg	44	45	59	59	59

C: cooling mode
H: heating mode
H-M-L = High - Medium - Low speed

RM_DTP
HIGH STATIC DUCT



Toshiba's high static pressure ducts are specifically designed to air-condition large open spaces, due to their impressive air flow characteristics.

Comfort

- 3-speed DC fan motor provides the correct air flow, whilst maximising energy savings.
- Compatible with metal or textile duct.

Adaptability

- Designed to be lightweight, making the installation process quick and easy.
- With 7 step settings the static pressure of the system can range from 50 to 250 Pa.
- Up to 5,600m³/h air flow to blow the air into large rooms.

Easy to install

- Electronic components accessible from outside the unit.
- Air filter and drain pump available as an option.



SCOP MAX



3.51

CAPACITY



20kW > 27kW

OPERATION



-27°C > +52°C

The DTP high static duct is compatible with textile duct diffusion system to blow the air smoothly all over the treated room.



R410A
with TOSHIBA



INDOOR UNITS

RAV-RM2241DTP-E1/TR1
RAV-RM2801DTP-E1/TR1



OUTDOOR UNITS

RAV-SM2246AT8-E/TR
RAV-SM2806AT8-E/TR



REMOTE CONTROLS

RBC-AXU31-E

RBC-AMSU51E-ES(EN)
RBC-AMTU31-E
RBC-ASCU11-E

HIGH STATIC DUCT

HIGH STATIC DUCT Performance data with Big DI Inverter Series 4

Outdoor unit	RAV-SM2246AT8-E/TR		RAV-SM2806AT8-E/TR
Indoor unit (High Static duct)	RAV-RM2241DTP-E1/TR1		RAV-RM2801DTP-E1/TR1
Cooling capacity	kW	19	22.5
Cooling range (min. - max.)	kW	4.6 - 22.4	4.6 - 27
Power input (min. - rated - max.)	kW C	5.86	7.98
EER	W/W	3.24	2.82
SEER		4.80	4.80
Energy efficiency class	C	-	-
Annual energy consumption	kWh	2930	3990
Heating capacity	kW	22.4	27.0
Heating range (min. - max.)	kW	4.6 - 25	4.6 - 31.5
Power input (min. - rated - max.)	kW H	5.89	7.78
COP	W/W	3.80	3.47
SCOP		3.51	3.50
Energy efficiency class	H	-	-

HIGH STATIC DUCT Physical data indoor

Indoor unit	RAV-RM2241DTP-E1/TR1		RAV-RM2801DTP-E1/TR1
Max air flow	m ³ /h - l/s	3800 - 1055	4800 - 1333
Sound pressure level	dB(A)	44	46
Sound power level	dB(A)	74	75
Dimensions (HxWxD)	mm	448x1400x900	448x1400x900
Weight	kg	97	97
Upper limit/min	Pa	50/250	50/250

C: cooling mode
H: heating mode

SDI - DI - Big DI
TWIN +



Toshiba's RAV range allows the connection of up to 4 indoor units, allowing a single system to satisfy the cooling and heating requirements of a much larger area.

Comfort

- Precise air flow control, accurately controls the distribution of the air regardless of the room size.

Adaptability

- Twin, triple or double twin configuration.
- Compatible with every type of LC indoor units: 4-way cassette, duct, high-wall, ceiling and floor standing.

Control

- One user-friendly controller for all the indoor units to simplify the control.

SCOP MAX



4.79

CAPACITY



7.1kW > 27kW

OPERATION



-27°C > +52°C

Toshiba RAV simplistic piping design allows multiple units to be connected via a simple branching methodology.

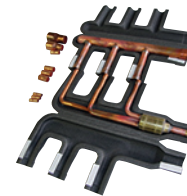

R410A 

TWIN SYSTEM - 2 indoor units connected

Outdoor unit

- Digital Inverter 4/5/6 HP
- or Super Digital Inverter 3/4/5/6 HP
- or Big Digital Inverter 8/10 HP

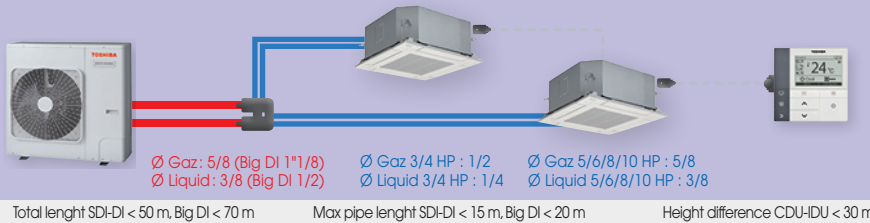

Remote

RBC-AMSU51E-ES/EN

TRIPLE SYSTEM - 3 indoor units connected

Outdoor unit

- Digital Inverter 6 HP
- Super Digital Inverter 6 HP
- or BIG Digital Inverter 8/10 HP

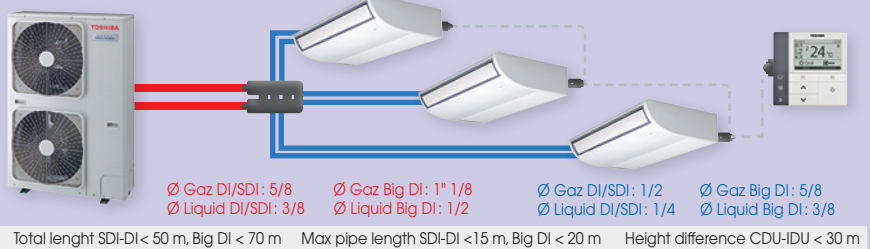

Remote

RBC-AMSU51E-ES/EN

W-TWIN SYSTEM - 4 indoor units connected

Outdoor unit

- Big Digital Inverter 8/10 HP

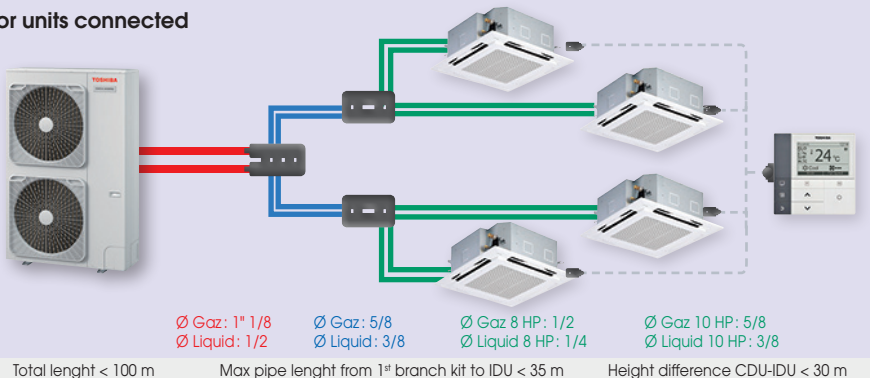

Remote

RBC-AMSU51E-ES/EN

TWIN SDI

Cooling & heating

Indoor unit model	Outdoor unit RAV-	Indoor unit RAV-	HP	Cooling capacity		Heating capacity		EER	SEER	COP	SCOP	Energy class
				min. - nominal - max kW	min. - nominal - max kW							
4-way cassette	SP1104ATF-E1	RM561UTP-E	4	2.6 - 10.0 - 12.0	2.4 - 11.2 - 13.0	4.52	6.60	4.79	4.28	A+++		
	SP1104AT8-E1	RM561UTP-E	4	2.6 - 10.0 - 12.0	2.4 - 11.2 - 15.6	4.22	6.57	4.63	4.28	A+++		
	SP1404AT-E1	RM801UTP-E	5	2.6 - 12.5 - 14.0	2.4 - 14.0 - 16.5	3.96	6.96	4.36	4.22	--		
	SP1404AT8-E1	RM801UTP-E	5	2.6 - 12.5 - 14.0	2.4 - 14.0 - 18.0	3.61	6.87	4.09	4.30	--		
	SP1604AT8-E1	RM801UTP-E	6	2.6 - 14.0 - 16.0	2.4 - 16.0 - 19.0	3.12	6.70	3.72	4.24	--		
Compact 4-way cassette	SP804ATP-E	RM401MUT-E	3	1.9 - 7.1 - 8.0	1.3 - 8.0 - 10.6	3.66	6.13	3.83	4.21	A+++		
	SP1104AT-E1	RM561MUT-E	4	2.6 - 10.0 - 12.0	2.4 - 11.2 - 13.0	3.76	6.14	3.72	3.95	A++		
	SP1104AT8-E1	RM561MUT-E	4	2.6 - 10.0 - 12.0	2.4 - 11.2 - 14.0	3.76	6.10	3.72	3.93	A++		
Ducted	SP804ATP-E	RM401BTP-E	3	1.9 - 7.1 - 8.0	1.3 - 8.0 - 10.6	3.45	5.88	3.62	4.00	A+		
	SP1104AT-E1	RM561BTP-E	4	2.6 - 10.0 - 12.0	2.4 - 11.2 - 13.0	3.79	5.65	4.04	3.87	A+		
	SP1104AT8-E1	RM561BTP-E	4	2.6 - 10.0 - 12.0	2.4 - 11.2 - 15.6	3.79	5.65	4.04	3.87	A+		
	SP1404AT-E1	RM801BTP-E	5	2.6 - 12.5 - 14.0	2.4 - 14.0 - 16.5	3.26	5.55	3.81	3.84	--		
	SP1404AT8-E1	RM801BTP-E	5	2.6 - 12.5 - 14.0	2.4 - 14.0 - 18.0	3.24	5.49	3.81	3.96	--		
Slim duct	SP1604AT8-E1	RM801BTP-E	6	2.6 - 14.0 - 16.0	2.4 - 16.0 - 19.0	3.01	5.45	3.48	3.94	--		
	SP804ATP-E	RM401SDT-E	3	1.9 - 7.1 - 8.0	1.3 - 8.0 - 10.6	3.21	5.38	3.70	3.88	AA		
	SP1104AT-E1	RM561SDT-E	4	2.6 - 10.0 - 12.0	2.4 - 11.2 - 13.0	3.61	5.6	4.19	3.84	A+		
Ceiling	SP1104AT8-E1	RM561SDT-E	4	2.6 - 10.0 - 12.0	2.4 - 11.2 - 14.0	3.58	5.55	4.19	3.84	AA		
	SP1104AT-E1	RM561CTP-E	4	2.6 - 10.0 - 12.0	2.4 - 11.2 - 13.0	4.08	6.18	4.69	4.27	A+++		
	SP1104AT8-E1	RM561CTP-E	4	2.6 - 10.0 - 12.0	2.4 - 11.2 - 14.0	4.22	6.35	4.43	4.41	A+++		
	SP1404AT-E1	RM801CTP-E	5	2.6 - 12.5 - 14.0	2.4 - 14.0 - 16.5	3.21	6.11	3.87	4.2	--		
	SP1404AT8-E1	RM801CTP-E	5	2.6 - 12.5 - 14.0	2.4 - 14.0 - 18.0	3.36	6.04	3.93	4.19	--		
High-wall	SP1604AT8-E1	RM801CTP-E	6	2.6 - 14.0 - 16.0	2.4 - 16.0 - 19.0	3.11	5.97	3.71	4.18	--		
	SP1104AT-E1	RM561KRT-E	4	2.6 - 10.0 - 12.0	2.4 - 11.2 - 13.0	3.61	5.6	4.00	3.87	A+		
	SP1104AT8-E1	RM561KRT-E	4	2.6 - 10.0 - 12.0	2.4 - 11.2 - 14.0	3.42	5.51	3.93	3.87	AA		
	SP1404AT-E1	RM801KRT-E	5	2.6 - 12.3 - 13.5	2.4 - 14.0 - 16.5	3.17	6.19	3.66	4.06	--		
	SP1404AT8-E1	RM801KRT-E	5	2.6 - 12.3 - 13.5	2.4 - 14.0 - 18.0	3.08	6.12	3.61	4.09	--		
Floor standing	SP1604AT8-E1	RM801KRT-E	6	2.6 - 14.0 - 16.0	2.4 - 16.0 - 19.0	2.75	6.06	3.28	4.07	--		
	SP1104AT-E1	RM561FF-EN/ES	4	2.6 - 10.0 - 12.0	2.4 - 11.2 - 13.0	3.68	5.87	3.73	3.95	A+/A		
	SP1104AT8-E1	RM561FF-EN/ES	4	2.6 - 10.0 - 12.0	2.4 - 11.2 - 15.6	3.68	5.73	3.73	3.95	A+/A		
	SP1404AT-E1	RM801FF-EN/ES	5	2.6 - 12.5 - 14.0	2.4 - 14.0 - 16.5	3.03	5.42	3.26	3.97	-		
	SP1404AT8-E1	RM801FF-EN/ES	5	2.6 - 12.5 - 14.0	2.4 - 14.0 - 18.0	3.18	5.36	3.26	3.95	-		
SP1604AT8-E1	RM801FF-EN/ES	6	2.6 - 14.0 - 16.0	2.4 - 16.0 - 19.0	2.82	5.33	3.18	3.92	-			

LIGHT COMMERCIAL

TRIPLE SDI



Cooling & heating

Indoor unit model	Outdoor unit RAV-	Indoor unit RAV-	HP	Cooling capacity		Heating capacity		EER	SEER	COP	SCOP	Energy class
				min. - nominal - max kW	min. - nominal - max kW							
4-way cassette	SP1604AT8-E1	RM561UTP-E	6	2.6 - 14.0 - 16.0	2.4 - 16.0 - 19.0	3.12	6.65	3.72	4.24	-		
Compact 4-way cassette	SP1604AT8-E1	RM561MUT-E	6	2.6 - 14.0 - 16.0	2.4 - 16.0 - 19.0	2.82	6.03	3.49	4.13	-		
Ducted	SP1604AT8-E1	RM561BTP-E	6	2.6 - 14.0 - 16.0	2.4 - 16.0 - 19.0	3.01	5.38	3.48	3.94	-		
Slim duct	SP1604AT8-E1	RM561SDT-E	6	2.6 - 14.0 - 16.0	2.4 - 16.0 - 19.0	2.81	5.92	3.48	4.07	-		
Ceiling	SP1604AT8-E1	RM561CTP-E	6	2.6 - 14.0 - 16.0	2.4 - 16.0 - 19.0	3.11	4.99	3.71	3.95	-		
High-wall	SP1604AT8-E1	SM566KRT-E	6	2.6 - 14.0 - 16.0	2.4 - 16.0 - 19.0	2.75	6.03	3.28	4.07	-		
Floor standing	SP1604AT8-E1	RM561FF-EN/ES	6	2.6 - 14.0 - 16.0	2.4 - 16.0 - 19.0	2.76	4.6	3.12	3.64	-		



Cooling & heating

Indoor unit model	Outdoor unit RAV-	Indoor unit RAV-	HP	Cooling capacity min. - nominal - max kW	Heating capacity min. - nominal - max kW	EER	SEER	COP	SCOP	Energy class
4-way cassette	SM1104ATP-E	RM561UTP-E	4	3.0 - 10.0 - 11.2	3.0 - 11.2 - 13.0	3.31	5.72	3.82	4.28	/
	SM1104AT8P-E	RM561UTP-E	4	3.0 - 10.0 - 11.2	3.0 - 11.2 - 13.0	3.31	5.72	3.82	4.28	/
	SM1404ATP-E	RM801UTP-E	5	3.0 - 12.0 - 13.2	3.0 - 12.8 - 16.0	2.80	5.25	3.76	4.19	/
	SM1404AT8P-E	RM801UTP-E	5	3.0 - 12.0 - 13.2	3.0 - 12.8 - 16.0	2.80	5.25	3.76	4.19	/
"Compact 4-way cassette"	SM1603AT-E1	RM801UTP-E	6	3.0 - 14.0 - 16.0	3.0 - 16.0 - 18.0	3.12	5.28	3.61	4.05	/
	SM1104ATP-E	RM561MUT-E	4	3.0 - 10.0 - 11.2	3.0 - 11.2 - 13.0	3.17	5.51	3.26	4.00	/
Ducted	SM1104AT8P-E	RM561MUT-E	4	3.0 - 10.0 - 11.2	3.0 - 11.2 - 13.0					/
	SM1104ATP-E	RM561BTP-E	4	3.0 - 10.0 - 11.2	3.0 - 11.2 - 12.5	3.18	5.1	3.75	4.14	/
	SM1104AT8P-E	RM561BTP-E	4	3.0 - 10.0 - 11.2	3.0 - 11.2 - 12.5	3.18	5.1	3.75	4.14	/
	SM1404ATP-E	RM801BTP-E	5	3.0 - 12.1 - 13.2	3.0 - 12.8 - 16.0	2.74	4.94	3.61	3.95	/
Slim duct	SM1404AT8P-E	RM801BTP-E	5	3.0 - 12.1 - 13.2	3.0 - 12.8 - 16.0	2.74	5.03	3.61	3.95	/
	SM1603AT-E1	RM801BTP-E	6	3.0 - 14.0 - 16.0	3.0 - 16.0 - 18.0	2.73	4.70	3.41	3.74	/
	SM1104ATP-E	RM561SDT-E	4	3.0 - 10.0 - 11.2	3.0 - 11.2 - 12.5	3.14	5.09	3.75	4.16	/
	SM1104AT8P-E	RM561SDT-E	4	3.0 - 10.0 - 11.2	3.0 - 11.2 - 12.5	3.14	5.09	3.75	4.16	/
Ceiling	SM1104ATP-E	RM561CTP-E	4	3.0 - 10.0 - 11.2	3.0 - 11.2 - 12.5	3.22	5.7	3.81	4.27	/
	SM1104AT8P-E	RM561CTP-E	4	3.0 - 10.0 - 11.2	3.0 - 11.2 - 12.5	3.22	5.7	3.81	4.27	/
	SM1404ATP-E	RM801CTP-E	5	3.0 - 12.1 - 13.2	3.0 - 12.8 - 16.0	2.74	5.12	3.73	4.20	/
	SM1404AT8P-E	RM801CTP-E	5	3.0 - 12.1 - 13.2	3.0 - 12.8 - 16.0	2.74	5.13	3.73	4.20	/
High-wall	SM1603AT-E1	RM801CTP-E	6	3.0 - 14.0 - 16.0	3.0 - 16.0 - 18.0	3.01	4.95	3.47	3.95	/
	SM1104ATP-E	RM561KRTP-E	4	3.0 - 10.0 - 11.2	3.0 - 11.2 - 12.5	3.19	5.13	3.75	4.18	/
	SM1104AT8P-E	RM561KRTP-E	4	3.0 - 10.0 - 11.2	3.0 - 11.2 - 12.5	3.19	5.13	3.75	4.18	/
	SM1404ATP-E	RM801KRTP-E	5	3.0 - 12.1 - 13.0	3.0 - 12.8 - 16.0	2.57	5.11	3.37	4.05	/
Floor standing	SM1404AT8P-E	RM801KRTP-E	5	3.0 - 12.1 - 13.0	3.0 - 12.8 - 16.0	2.57	5.12	3.37	4.03	/
	SM1603AT-E1	RM801KRTP-E	6	3.0 - 14.0 - 16.0	3.0 - 16.0 - 18.0	2.75	5.00	3.21	3.9	/
	SM1104ATP-E	RM561FT-EN/ES	4	3.0 - 10.0 - 11.2	3.0 - 11.2 - 12.5	3.10	5.10	3.51	3.92	A/A
	SM1104AT8P-E	RM561FT-EN/ES	4	3.0 - 10.0 - 11.2	3.0 - 11.2 - 12.5	3.10	5.10	3.51	3.92	A/A
	SM1404ATP-E	RM801FT-EN/ES	5	3.0 - 12.1 - 13.2	3.0 - 12.8 - 16.0	2.57	4.80	3.24	3.90	/
	SM1404AT8P-E	RM801FT-EN/ES	5	3.0 - 12.1 - 13.2	3.0 - 12.8 - 16.0	2.57	4.80	3.24	3.90	/
	SM1603AT-E1	RM801FT-EN/ES	6	3.0 - 14.0 - 16.0	3.0 - 16.0 - 18.0	2.76	4.60	3.12	3.64	/



Cooling

Indoor unit model	Outdoor unit RAV-	Indoor unit RAV-	HP	Cooling capacity min. - nominal - max kW	Heating capacity min. - nominal - max kW	EER	SEER	COP	SCOP	Energy class
4-way cassette	SM1603AT-E1	RM561UTP-E	6	3.0 - 14.0 - 16.0	3.0 - 16.0 - 18.0	3.12	5.28	3.61	4.05	-
Compact 4-way cassette	SM1603AT-E1	RM561MUT-E	6	3.0 - 14.0 - 16.0	3.0 - 16.0 - 18.0	4.92	4.92	3.98	3.98	-
Ducted	SM1603AT-E1	RM561BTP-E	6	3.0 - 14.0 - 16.0	3.0 - 16.0 - 18.0	2.73	4.70	3.41	3.74	-
Slim duct	SM1603AT-E1	RM561SDT-E	6	3.0 - 14.0 - 16.0	3.0 - 16.0 - 18.0	2.81	4.86	3.41	3.92	-
Ceiling	SM1603AT-E1	RM561CTP-E	6	3.0 - 14.0 - 16.0	3.0 - 16.0 - 18.0	3.01	4.95	3.47	3.95	-
High-wall	SM1603AT-E1	RM561KRTP-E	6	3.0 - 14.0 - 16.0	3.0 - 16.0 - 18.0	2.75	6.06	3.21	4.07	-
Floor standing	SM1603AT-E1	RM561FT-EN/ES	6	3.0 - 14.0 - 16.0	3.0 - 16.0 - 18.0	2.76	4.6	3.12	3.64	-

TWIN BIG DI

Cooling & heating

Indoor unit model	Outdoor unit RAV-	Indoor unit RAV-	HP	Cooling capacity	Heating capacity	EER	SEER	COP	SCOP	Energy class
				min. - nominal - max kW	min. - nominal - max kW					
4-way cassette	SM2246AT8-E	RM1101UTP-E	8	4.6 - 20.0 - 22.4	4.6 - 22.4 - 25.0	3.60	6.78	4.10	4.05	-
	SM2806AT8-E	RM1401UTP-E	10	4.6 - 23.5 - 27.0	4.6 - 27.0 - 31.5	3.00	6.33	3.67	3.90	-
Ducted	SM2246AT8-E	RM1101BTP-E	8	4.6 - 20.0 - 22.4	4.6 - 22.4 - 25.0	3.24	5.23	3.90	3.72	-
	SM2806AT8-E	RM1401BTP-E	10	4.6 - 23.5 - 27.0	4.6 - 27.0 - 31.5	2.65	5.10	3.50	3.64	-
Ceiling	SM2246AT8-E	RM1101CTP-E	8	4.6 - 20.0 - 22.4	4.6 - 22.4 - 25.0	3.24	5.89	3.80	3.79	-
	SM2806AT8-E	RM1401CTP-E	10	4.6 - 23.5 - 27.0	4.6 - 27.0 - 31.5	3.24	5.26	3.45	3.65	-
Floor standing	SM2246AT8-E	RM1101FT-EN/ES	8	4.6 - 20.0 - 22.4	4.6 - 22.4 - 25.0	3.24	5.12	3.86	3.6	-
	SM2806AT8-E	RM1401FT-EN/ES	10	4.6 - 23.5 - 27.0	4.6 - 27.0 - 31.5	2.65	4.91	3.18	3.57	-

TRIPLE BIG DI

Cooling & heating

Indoor unit model	Outdoor unit RAV-	Indoor unit RAV-	HP	Cooling capacity	Heating capacity	EER	SEER	COP	SCOP	Energy class
				min. - nominal - max kW	min. - nominal - max kW					
4-way cassette	SM2246AT8-E	RM801UTP-E	8	4.6 - 20.0 - 22.4	4.6 - 22.4 - 25.0	3.60	6.82	4.10	4.05	-
	SM2806AT8-E	RM801UTP-E	10	4.6 - 23.5 - 27.0	4.6 - 27.0 - 31.5	3.00	6.36	3.67	3.91	-
Ducted	SM2246AT8-E	RM801BTP-E	8	4.6 - 20.0 - 22.4	4.6 - 22.4 - 25.0	3.24	5.44	3.24	3.73	-
	SM2806AT8-E	RM801BTP-E	10	4.6 - 23.5 - 27.0	4.6 - 27.0 - 31.5	2.65	5.28	2.65	3.65	-
Ceiling	SM2246AT8-E	RM801CTP-E	8	4.6 - 20.0 - 25.0	4.6 - 22.4 - 25.0	3.24	5.81	3.80	3.79	-
	SM2806AT8-E	RM801CTP-E	10	4.6 - 23.5 - 27.0	4.6 - 27.0 - 31.5	2.62	5.26	3.45	3.66	-
High-wall	SM2246AT8-E	RM801KRTP-E	8	4.6 - 20.0 - 22.4	4.6 - 22.4 - 25.0	3.00	5.80	3.55	3.76	-
	SM2806AT8-E	RM801KRTP-E	10	4.6 - 23.5 - 27.0	4.6 - 27.0 - 31.5	2.55	5.41	3.41	3.63	-
Floor standing	SM2246AT8-E	RM801FT-EN/ES	8	4.6 - 20.0 - 22.4	4.6 - 22.4 - 25.0	3.24	5.14	3.86	3.6	-
	SM2806AT8-E	RM801FT-EN/ES	10	4.6 - 23.5 - 27.0	4.6 - 27.0 - 31.5	2.65	4.97	3.18	3.58	-

DOUBLE-TWIN BIG DI

Cooling & heating

Indoor unit model	Outdoor unit RAV-	Indoor unit RAV-	HP	Cooling capacity	Heating capacity	EER	SEER	COP	SCOP	Energy class
				min. - nominal - max kW	min. - nominal - max kW					
4-way cassette	SM2246AT8-E	RM561UTP-E	8	9.8 - 20.0 - 22.4	9.8 - 20.0 - 22.4	3.21	6.82	3.85	4.05	-
	SM2806AT8-E	RM801UTP-E	10	9.8 - 23.0 - 27.0	9.8 - 27.0 - 31.5	2.81	6.28	3.61	3.90	-
Compact 4-way cassette	SM2246AT8-E	RM561MUT-E	8	4.6 - 20.0 - 22.4	4.6 - 22.4 - 25.0	3.15	6.24	3.55	4.03	-
Ducted	SM2246AT8-E	RM561BTP-E	8	4.6 - 20.0 - 25.0	4.6 - 22.4 - 25.0	3.24	5.39	3.90	3.73	-
	SM2806AT8-E	RM801BTP-E	10	4.6 - 23.5 - 27.0	4.6 - 27.0 - 31.5	2.65	5.22	3.50	3.65	-
Slim duct	SM2246AT8-E	RM561SDT-E	8	4.6 - 20.0 - 22.4	4.6 - 22.4 - 25.0	3.00	5.65	3.55	3.86	-
Ceiling	SM2246AT8-E	RM561CTP-E	8	4.6 - 20.0 - 22.4	4.6 - 22.4 - 25.0	3.24	5.90	3.80	3.79	-
	SM2806AT8-E	RM801CTP-E	10	4.6 - 23.5 - 27.0	4.6 - 27.0 - 31.5	2.62	5.16	3.45	3.65	-
High-wall	SM2246AT8-E	RM561KRTP-E	8	4.6 - 20.0 - 22.4	4.6 - 22.4 - 25.0	3.60	5.82	4.10	3.76	-
	SM2806AT8-E	RM801KRTP-E	10	4.6 - 23.5 - 27.0	4.6 - 27.0 - 31.5	2.55	5.33	3.41	3.62	-
Floor standing	SM2246AT8-E	RM561FT-EN/ES	8	4.6 - 20.0 - 25.0	4.6 - 22.4 - 25.0	3.24	5.2	3.86	3.60	-
	SM2806AT8-E	RM801FT-EN/ES	10	4.6 - 23.5 - 27.0	4.6 - 27.0 - 31.5	2.65	5.0	3.18	3.6	-

RAV-DXC STANDARD DX KIT



Enables the connection of a third-party air handling unit (with DX coil) to Toshiba LC outdoor units.

Global

- Compatible with the majority of air handling units with a DX coil fitted inside (capacity ranges from 4.6 to 27kW).
- Can operate in both heating and cooling modes, depending on end user requirements.

Control

- Control achieved using a standard Toshiba remote controller.
- Algorithm based on air suction temperature.

Easy to install

- Capacity set by DN code adjustment during installation.
- Extended 5 meters sensor leads pre-fitted to improve installation time and flexibility.
- Relay inputs insulated to prevent accidental wiring errors, damaging the PCB.

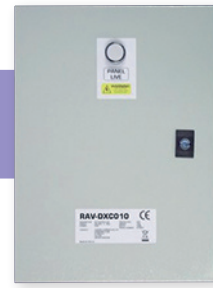

MAX AIR FLOW



Up to **5,000m³/h**

CAPACITY



4.6kW > 27kW

OPERATION



-27°C > +52°C

> Input/output signal available:

- Operation output,
- AC fan motor output,
- Alarm output,
- External On/Off input,
- Safety-cut output.



R410A 
with TOSHIBA



INDOOR UNITS

RAV-DXC010

SDI



OUTDOOR UNITS

RAV-SP564ATP-E
RAV-SP804ATP-E
RAV-SP1104AT(8)-E1
RAV-SP1404AT(8)-E1
RAV-SP1604AT8-E1

DI



RAV-SM564ATP-E
RAV-SM804ATP-E
RAV-SM1104AT(8)P-E
RAV-SM1404AT(8)P-E
RAV-SM1603AT-E1

BIG DI



RAV-SM2246AT8-E
RAV-SM2806AT8-E



REMOTE CONTROLS

RBC-AMT32E
(included)

STANDARD DX KIT

STANDARD DX KIT Performances

DX Controller unit	RAV-	DXC010	DXC010	DXC010	DXC010	DXC010	DXC010	DXC010
Outdoor Unit Cooling Capacity		2 HP	3 HP	4 HP	5 HP	6 HP	8 HP	10 HP
RANGE	DI - Big DI	RAV-SM564ATP-E	RAV-SM804ATP-E	RAV-SM1104AT(8)P-E	RAV-SM1404AT(8)P-E	RAV-SM1603AT-E1	RAV-SM2246AT8-E	RAV-SM2806AT8-E
	SDI	RAV-SP564ATP-E	RAV-SP804ATP-E	RAV-SP1104AT(8)-E1	RAV-SP1404AT(8)-E1	RAV-SP1604AT8-E1		
Cooling capacity (min-rated* -max) DI	kW	4.1 - 5.3 - 5.6	5.4 - 7.1 - 7.4	7.2 - 10.0 - 11.2	10.1 - 12.5 - 13.2	12.6 - 14.0 - 16.0	14.1 - 19.0 - 22.4	20.1 - 22.5 - 27.0
Cooling capacity (min-rated* -max) SDI	kW	4.1 - 5.3 - 5.6	5.4 - 7.1 - 8.0	7.2 - 10.0 - 12.0	10.1 - 12.5 - 14.0			
Heating capacity (min-rated* -max) DI	kW	4.6 - 5.6 - 6.3	7.5 - 8.0 - 9.0	8.1 - 11.2 - 12.5	11.3 - 14.0 - 16.0	14.1 - 16.0 - 19.0	16.1 - 22.4 - 25.0	22.5 - 27.0 - 31.5
Heating capacity (min-rated* -max) SDI	kW	4.6 - 5.6 - 7.4	7.5 - 8.0 - 10.6	8.1 - 11.2 - 13.0	11.3 - 14.0 - 16.5			
AHU Air Volume (min-rated* -max)	m ³ /h	720 - 900 - 1080	1060 - 1320 - 1580	1280 - 1600 - 1920	1680 - 2100 - 2520	1850 - 2800 - 3740	2880 - 3600 - 4320	3360 - 4200 - 5040
Coil Internal Volume (min-max)	dm ³	0.8 - 1.1	1.0 - 1.4	1.5 - 2.1	1.7 - 2.7	1.7 - 3.2	3.0 - 4.2	3.0 - 5.4

STANDARD DX KIT Physical data

DX Controller unit	RAV-	DXC010
Dimensions (HxWxD)	mm	400x300x165
Weight	kg	10
Operating range - Cooling coil "Air on" temp	°C	15°CWB±24°CWB
Operating range - Heating coil "Air on" temp	°C	15°CDB±28°CDB
Power supply	V-ph-Hz	220/240-1-50

C: cooling mode
H: heating mode

Cooling and heating output figures are based on calculations and "general" test data. All figures are to be taken as approximations. The properties of the third party DX Coil will have an affect on the performance of the outdoor units.

All capacity data shown is based on the following Rated Conditions:

- Cooling (Rated): Indoor air temperature 27°C db / 19°C wb, Outdoor air temperature 35°C db
- Heating (Rated): Indoor air temperature 20°C db, Outdoor air temperature 7°C db / 6°C wb.

Notes:

Cooling Mode Coil "Air On" Temp: Minimum 15°CWB (18°CDB) / Maximum 24°CWB (32°CDB)

Air temperatures flowing across the coil below this level, can in some circumstances, cause icing and freezing issues with the coil and eventually forcing the system to shut down and also be detrimental to the outdoor unit itself.

Heating Mode Coil "Air On" Temp: Minimum 15°CDB / Maximum 28°CDB

In the reserve cycle mode when the outdoor unit is producing hot gas, the coil in the AHU is effectively the condenser. Air temperatures flowing across the coil below this level, can cause over condensing of the refrigerant.

This can result in liquid being returned to the compressor which will cause a mechanical failure of the outdoor unit.

Low air temperatures will also cause the unit to use it's defrost mode more often.

Fresh Air Intake

If you wish to use Fresh Air which in outside of these Coil "Air On" limits it has to either be pre-conditioned by other equipment, or mixed with return air (or a combination of both) so that it remains inside these limits, in order to ensure reliable operation.

Automatic Mode

Please be aware that frequent mode changes could occur when using Automatic mode.

TA sensor

The TA sensor should be positioned in the return air duct. In case, it's not representative enough of the occupants area temperature, remote temperature sensor TCB -TC21LE2 should be used in the room.

RBC-DXC
0/10V DX KIT



Enables connection and control of Toshiba LC outdoor units to a third-party air handling unit (with DX coil).

Global

- Compatible with the majority of air handling units with a DX coil fitted inside (capacity ranges from 4.6 to 27kW).
- Air flow rate from 480 to 5040m³/h.

Control

- Capacity control and selection mode of the Toshiba outdoor unit directly from the AHU controller through a 0/10v signal.

Easy to install

- Capacity set by DN code during installation.
- Extended 5 meters sensor leads pre-fitted to improve installation time and flexibility.
- Relay isolated inputs to prevent accidental wiring errors damaging the PCB.



AIR FLOW



Up to 4200m³/h

CAPACITY



2.5kW > 27kW

OPERATION



-27°C > +52°C

> Compatible with both LC and VRF systems.
(made possible via simple switch change on PCB)



R410A



INDOOR UNITS

RBC-DXC031

SDI



OUTDOOR UNITS

RAV-SP404ATP-E
RAV-SP564ATP-E
RAV-SP804ATP-E
RAV-SP1104AT(8)-E1
RAV-SP1404AT(8)-E1
RAV-SP1604AT8-E1

DI



RAV-SM304ATP-E
RAV-SM404ATP-E
RAV-SM564ATP-E
RAV-SM804ATP-E
RAV-SM1104AT(8)P-E
RAV-SM1404AT(8)P-E
RAV-SM1603AT-E1

BIG DI



RAV-SM2246AT8-E
RAV-SM2806AT8-E



REMOTE CONTROLS

RBC-AMTU31-E

0/10V DX KIT

0/10V DX KIT Capacity table

LC / VRF DX Coil Controller Unit	RBC-	DXC031	DXC031	DXC031	DXC031	DXC031	DXC031	DXC031	DXC031	DXC031
DX PMV valve unit	-	-	-	-	-	-	-	-	-	-
Cooling capacity	kW	2.5	3.6	5.0	6.7	10.0	12.1	14.0	19.0	22.5
Heating capacity	kW	3.4	4.0	5.3	7.7	11.2	12.8	16.0	22.4	27.0
Power code	HP	1.0	1.5	2.0	3.0	4.0	5.0	6.0	8.0	10.0

0/10V DX KIT Performance and physical data

LC / VRF DX Coil Controller Unit	RBC-	DXC031	DXC031	DXC031	DXC031	DXC031	DXC031	DXC031	DXC031	DXC031
Minimum Air Flow rate	m ³ /h	480	522	720	1060	1280	1680	2080	2880	3360
Maximum Air Flow rate	m ³ /h	600	650	900	1320	1600	2100	2600	3600	4200
Dimensions (HxWxD)	mm	400x300x165	400x300x165	400x300x165	400x300x165	400x300x165	400x300x165	400x300x165	400x300x165	400x300x165
Weight	kg	8	8	8	8	8	8	8	8	8
Cable Max Length (Analogue Input) (Screened cable: 0.5 ~ 1.0 mm ²)	m	200	200	200	200	200	200	200	200	200
Cable Max Length (Digital Input) (Non screened cable: 1.5 ~ 2.5 mm ²)	m	100	100	100	100	100	100	100	100	100
Cable Max Length (Digital Output) (Non screened cable: 1.5 ~ 2.5 mm ²)	m	500	500	500	500	500	500	500	500	500
Cable Max Length (TCC Link) (Screened cable: 1.5 ~ 2.5 mm ²)	m	1000	1000	1000	1000	1000	1000	1000	1000	1000
Standard Rating	IP	65	65	65	65	65	65	65	65	65
Operating temperature/humidity	°C / RH	5-40 / 10-90	5-40 / 10-90	5-40 / 10-90	5-40 / 10-90	5-40 / 10-90	5-40 / 10-90	5-40 / 10-90	5-40 / 10-90	5-40 / 10-90
Operating range - Cooling coil "Air on" temp	°C	15°CWB+24°CWB	15°CWB+24°CWB	15°CWB+24°CWB	15°CWB+24°CWB	15°CWB+24°CWB	15°CWB+24°CWB	15°CWB+24°CWB	15°CWB+24°CWB	15°CWB+24°CWB
Operating range - Heating coil "Air on" temp	°C	12°CDB+28°CDB	12°CDB+28°CDB	12°CDB+28°CDB	12°CDB+28°CDB	12°CDB+28°CDB	12°CDB+28°CDB	12°CDB+28°CDB	12°CDB+28°CDB	12°CDB+28°CDB
Outdoor Unit	DI - Big DI	RAV-SM304ATP-E	RAV-SM404ATP-E	RAV-SM564ATP-E	RAV-SM804ATP-E	RAV-SM1104AT(8)P-E	RAV-SM1404AT(8)P-E	RAV-SM1603AT-E1	RAV-SM2246AT8-E	RAV-SM2806AT8-E
	SDI		RAV-SP404ATP-E	RAV-SP564ATP-E	RAV-SP804ATP-E	RAV-SP1104AT(8)-E1	RAV-SP1404AT(8)-E1	RAV-SP1604AT8-E1		
Power supply		220 - 240V AC 50Hz	220 - 240V AC 50Hz	220 - 240V AC 50Hz	220 - 240V AC 50Hz	220 - 240V AC 50Hz	220 - 240V AC 50Hz	220 - 240V AC 50Hz	220 - 240V AC 50Hz	220 - 240V AC 50Hz

C: cooling mode
H: heating mode

Technical Limitations :

- Cooling & Heating output figures are based on calculations and "general" test data. All figures are to be taken as approximations.
- The properties of the 3rd Party DX Coil will have an effect on the performance of the Outdoor units.
- The DX Coil must be suitable for R410A.
- The design should allow operation as both an Evaporator and a Condenser (Features: Multiple circuits / Liquid Capillary Distributor / Gas Header).
- The standard Air volume flow rate is a guideline. The required capacity should determine DX-Interface size selection.
- The counter flow principle must be observed for the DX coil design.
- A Drain Pan must be fitted (even if only used in Heat mode) due to defrost cycles.
- It is recommended to fit droplet eliminator plates in the discharge air stream if used in Cool mode.
- 1:1 Connection: The DX Interface (0-10V) must be connected 1:1 with Toshiba outdoor units.
- Only Heating and Cooling Modes are available on the RBC-DXC031 (No Automatic or Fan Only).

RAV-CT
AIR CURTAINS

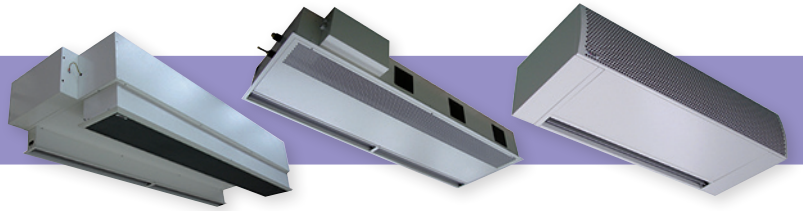

Air curtains are designed to be positioned above an entrance, providing a thermal curtain, which separates the outdoor and indoor environments. This historically has been produced by electrical heaters, however it is now possible to use a Toshiba heat pump system, with the added benefits of improved energy savings.

Energy savings

- Stop drafts and reduces infiltration of outdoor air into the heated or air-conditioned area.
- EC motors compliant with ERP lot 11.

Comfort

- By preventing the conditioned air to leave the building, or be affected by incoming air from the outside, the comfort levels inside the building are maintained, making it a more pleasant area for staff members and customers alike.

Functionnality

- Provides a pleasant entrance to customers, whilst ensuring undesirable smells, contaminants and small insects are kept outside of the conditioned space.

Adaptability

- Suitable for installation in the ceiling space above the door, only the inlet grille and discharge outlet will be visible.
- Available in door widths from 1.0m to 2.5m.

CAPACITY



8kW > 16kW

OPERATION



-20°C > +46°C

> The air is accelerated and forced through a narrow discharge along the length of the air curtain creating a liminar air flow.

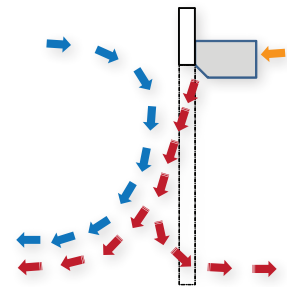

R410A >>> with TOSHIBA

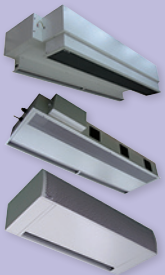

INDOOR UNITS

RAV-CT_CH-L/M
RAV-CT_UH-L/M
RAV-CT_BH-L/M

SDI



OUTDOOR UNITS

RAV-SP804ATP-E
RAV-SP1104AT(8)-E1
RAV-SP1404AT(8)-E1
RAV-SP1604AT8-E1

DI



RAV-SM804ATP-E
RAV-SM1104AT(8)P-E
RAV-SM1404AT(8)P-E
RAV-SM1603AT-E1



REMOTE CONTROLS

RBC-AMTU31-E

AIR CURTAINS

AIR CURTAINS Free-Hanging unit (CH)

Model Code	RAV-CT101CH-M	RAV-CT101CH-L	RAV-CT151CH-M	RAV-CT151CH-L	RAV-CT201CH-M	RAV-CT201CH-L	RAV-CT251CH-M	RAV-CT251CH-L
Outdoor Sizing hp	3.0	3.0	4.0	4.0	5.0	5.0	6.0	6.0
Heating Capacity kW	8.0	8.0	11.2	11.2	14.0	14.0	16.0	16.0
Air flow rate m ³ /h	1600	2210	2400	2950	3200	4420	4000	5160
Power Input Fan only kW	0.35	0.53	0.53	0.70	0.70	1.05	0.88	1.23
Door Width mm	1000	1000	1500	1500	2000	2000	2500	2500
Max Door Height m	3.0	3.2	3.0	3.2	3.0	3.2	3.0	3.2
Unit Weight kg	48	51	77	80	101	107	132	138
Sound Pressure dBA	54	55	55	56	56	57	57	58

AIR CURTAINS Cassette unit (UH)

Model Code	RAV-CT101UH-M	RAV-CT101UH-L	RAV-CT151UH-M	RAV-CT151UH-L	RAV-CT201UH-M	RAV-CT201UH-L	RAV-CT251UH-M	RAV-CT251UH-L
Outdoor Sizing hp	3.0	3.0	4.0	4.0	5.0	5.0	6.0	6.0
Heating Capacity kW	8.0	8.0	11.2	11.2	14.0	14.0	16.0	16.0
Air flow rate m ³ /h	1600	2210	2400	2950	3200	4420	4000	5160
Power Input Fan only kW	0.35	0.53	0.53	0.70	0.70	1.05	0.88	1.23
Door Width mm	1000	1000	1500	1500	2000	2000	2500	2500
Max Door Height m	3.0	3.2	3.0	3.2	3.0	3.2	3.0	3.2
Unit Weight kg	40	43	95	98	99	105	120	126
Sound Pressure dBA	54	55	55	56	56	57	57	58

AIR CURTAINS Built-in unit (BH)

Model Code	RAV-CT101BH-M	RAV-CT101BH-L	RAV-CT151BH-M	RAV-CT151BH-L	RAV-CT201BH-M	RAV-CT201BH-L	RAV-CT251BH-M	RAV-CT251BH-L
Outdoor Sizing hp	3.0	3.0	4.0	4.0	5.0	5.0	6.0	6.0
Heating Capacity kW	8.0	8.0	11.2	11.2	14.0	14.0	16.0	16.0
Air flow rate m ³ /h	1600	2210	2400	2950	3200	4420	4000	5160
Power Input Fan only kW	0.35	0.53	0.53	0.70	0.70	1.05	0.88	1.23
Door Width mm	1000	1000	1500	1500	2000	2000	2500	2500
Max Door Height m	3.0	3.2	3.0	3.2	3.0	3.2	3.0	3.2
Unit Weight kg	71	74	105	108	129	135	170	176
Sound Pressure dBA	54	55	55	56	56	57	57	58

AIR CURTAINS Outdoor units combination

Model Code (CH/UH/BH)	RAV-CT101**-L	RAV-CT101**-M	RAV-CT151**-L	RAV-CT151**-M	RAV-CT201**-L	RAV-CT201**-M	RAV-CT251**-L	RAV-CT251**-M
Door Width (mm)	1000	1000	1500	1500	2000	2000	2500	2500
Max Door Height (m)	3.2	3.0	3.2	3.0	3.2	3.0	3.2	3.0
DI - Single phase	RAV-SM804ATP-E	RAV-SM804ATP-E	RAV-SM1104ATP-E	RAV-SM1104ATP-E	RAV-SM1404ATP-E	RAV-SM1404ATP-E	RAV-SM1603AT-E1	RAV-SM1603AT-E1
DI - Three phase			RAV-SM1104AT8P-E	RAV-SM1104AT8P-E	RAV-SM1404AT8P-E	RAV-SM1404AT8P-E		
SDI - Single phase	RAV-SP804ATP-E	RAV-SP804ATP-E	RAV-SP1104AT-E1	RAV-SP1104AT-E1	RAV-SP1404AT-E1	RAV-SP1404AT-E1	RAV-SP1604AT-E1	RAV-SP1604AT-E1
SDI - Three phases			RAV-SP1104AT8-E1	RAV-SP1104AT8-E1	RAV-SP1404AT8-E1	RAV-SP1404AT8-E1	RAV-SP1604AT8-E1	RAV-SP1604AT8-E1

ESS RESIDENTIAL LIGHT COMMERCIAL BUSINESS RESIDENTIAL



The business solutions

VRF technology is the perfect solution for large commercial and industrial buildings such as offices, hotels, hospitals, leisure and shops.

The variable refrigerant flow technology combined with inverter compressor guarantees high efficiency levels, operational flexibility with limited maintenance requirements.

More over, the diversity of solutions makes VRF system the most flexible choice to satisfy all requirements.



> BUSINESS



EXCELLENCE IN SEASONAL EFFICIENCY

MiNi SMMS-e, SMMS-e, SMMS-u, SHRM-e



> CREATING BENEFITS AROUND COMFORT

> Benefits for the consultant



SMMS-u offers unlimited possibilities in terms of capacity, connectivity, indoor unit lineup and control solutions, providing the correct solution for your customers needs. Toshiba's intuitive selection tool will guide you through the selection process with minimal input from your side, ensuring trouble-free installation and operation. All SMMS-u systems come with the Eurovent certification as standard.

> Benefits for the user



There is nothing like a comfortable place to enjoy the present moment. Full of Toshiba innovations, the new SMMS-u guarantees all year round comfort combined with superior energy management, advanced air filtration and full control solutions for maximized product usability.

> Benefits for the installer



Designed to perform and engineered to perfection, SMMS-u excels in managing the heating, cooling, hot water and fresh air input into offices, shops, restaurants and domestic housing, with unrivalled connection flexibility. You can rely on Toshiba support, to assist you from the project phase to commissioning and troubleshooting.

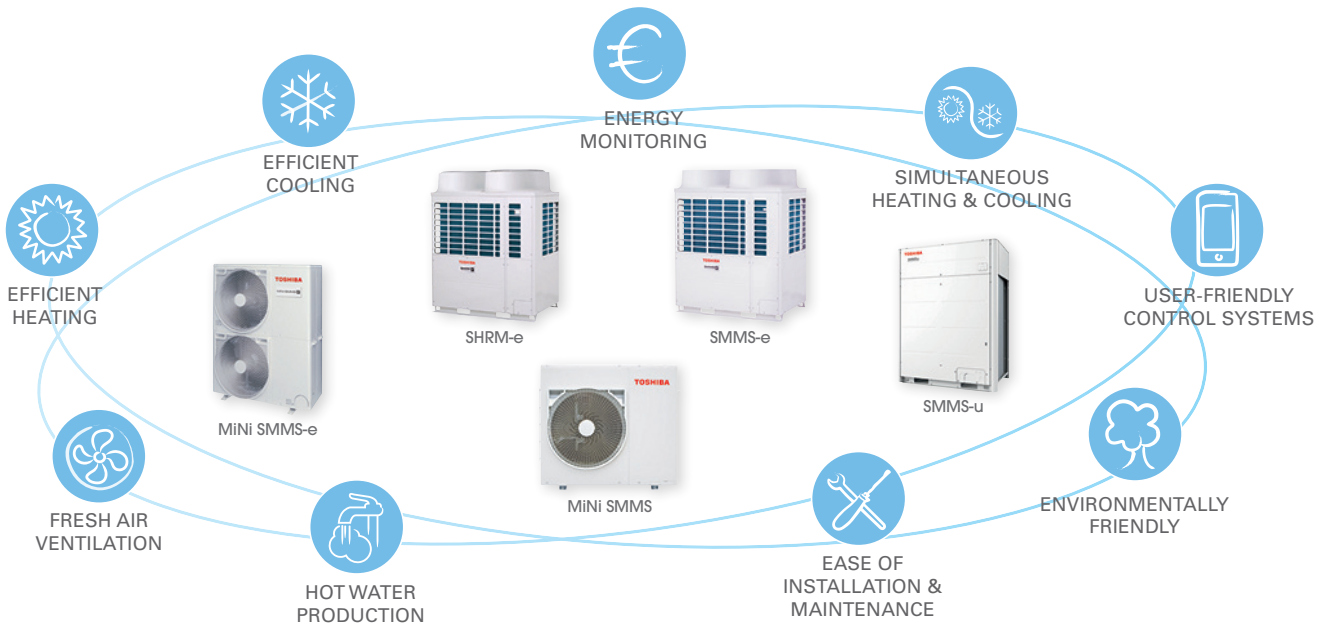

> HIGH EFFICIENCY AND LOW OPERATION COSTS

> Innovative compressor technology

Toshiba rotary compressor technology brings outstanding performances to all SMMS systems with no compromise on system reliability.



-  Large capacity
-  Less refrigerant needed
-  Low noise
-  Wide operating range
-  Low vibration
-  DLC treatment

> Infinite variable control

This feature has been continually evolved and developed, since its inception by TOSHIBA engineers back in 2004 with the original SMMS system. The control has the ability to adjust the compressor rotational speed in a near seamless 0.1 Hz steps. This control when matched with TOSHIBA's newest and latest Twin Rotary compressors, allows the system to respond precisely to the capacity needs of the end user, whilst minimizing energy losses.

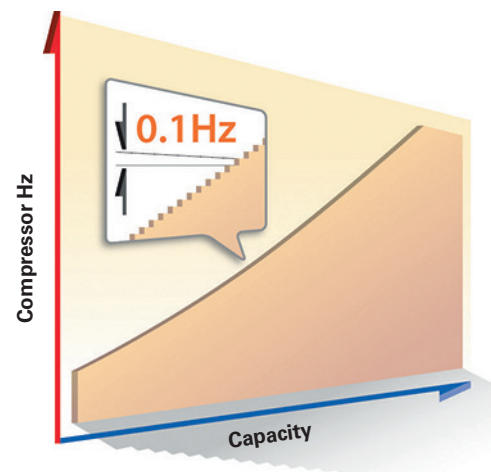

> Maximum part load and full load efficiencies

SMMS-u SEER

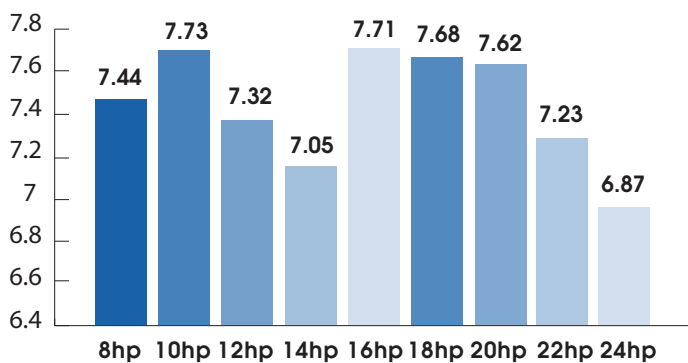

Thanks to Toshiba's unique twin rotary compressor, re-designed heat exchanger and "intelligent flow" technology, the Toshiba's VRF achieve a SEER of 9.68 (MiNi SMMS-e), one of the highest seasonal efficiency in the market.

Maximum efficiency is obtained under 50% part load conditions, under which VRF systems operate predominantly.

The expert use and evolution of Toshiba's core technologies have allowed the Toshiba VRF system to achieve the highest part load COP and EER in the industry.

> MiNi SMMS-e, SMMS-e, SMMS-u, SHRM-e



> SUPERIOR AIR COMFORT

> Intelligent defrost

Individual defrost: continuous heating up to 5 hours

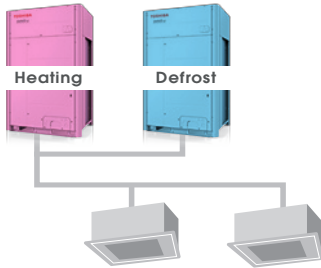

Kobetsu
No simultaneous defrost in combination configuration. Heating operation never stopped.

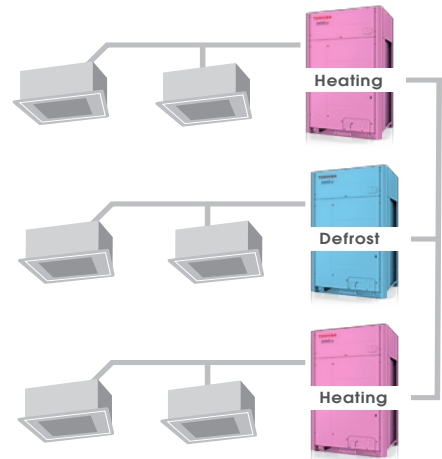

Renkey
No simultaneous defrost with multi system configuration. Heating operation never stopped.

* Applicable on SMMS-u only

> Dual set point for more precision

The Dual Set Point increases the system's energy efficiency and reduces overall running costs, with longer periods of time in thermal off mode. Heating and cooling temperatures at which the indoor unit will begin to operate can now be individually selected giving maximum flexibility to the user.

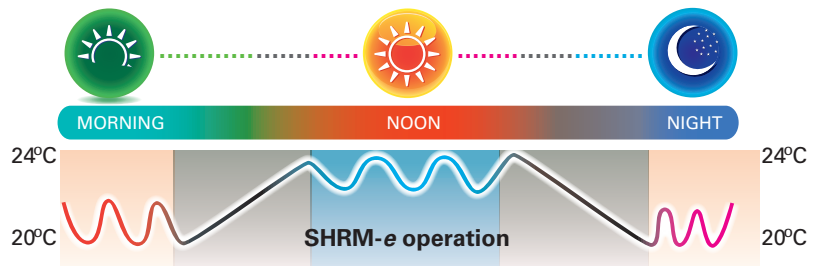

> Cool comfort with soft cooling mode

The development of the soft cooling mode provides a new level for cool comfort. You will have the freedom to personalize the air flow intensity, angle and direction directly from the remote control and enjoy the indoor environment at the right temperature without being directly exposed to the cold draft.

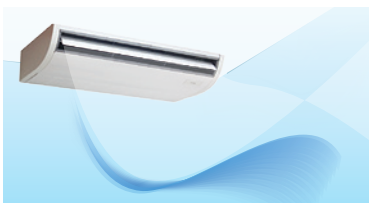

Standard operating mode

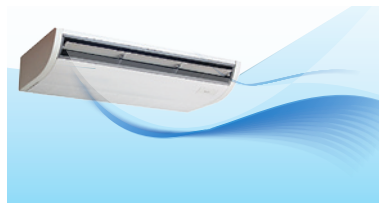

Soft cooling mode



> FLEXIBLE DESIGN AND QUICK INSTALLATION

> Piping design flexibility

Toshiba's piping technology makes them one of the industries leaders in system flexibility and ease of installation and with the e-series VRF system, the level of flexibility has increased further, giving more options to the contractor and installer alike.

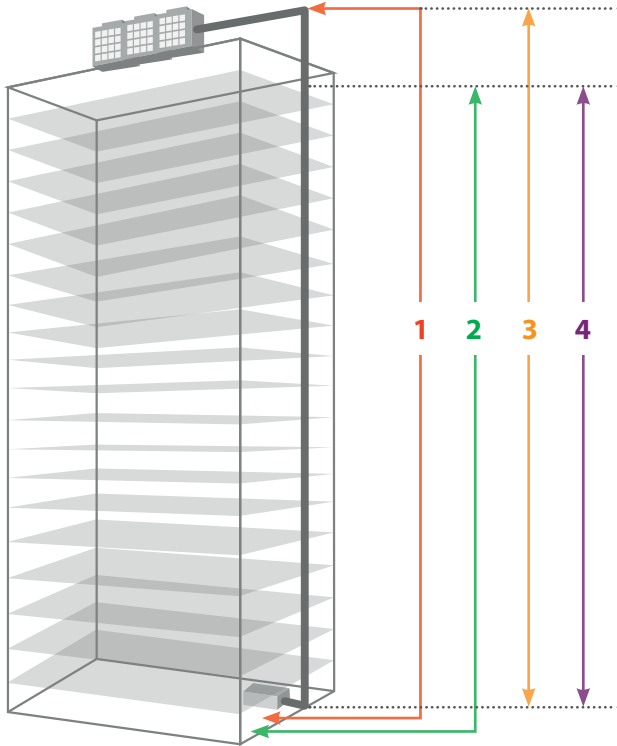

For more details, please refer to installation manuals.

1 Total piping length

Applied with Toshiba's unique and greatly improved technology, Toshiba's VRF can reach up to 1,200 meters maximum piping length.



**Total piping length
1,200 m***

2 Farthest equivalent length

The maximum equivalent distance between the outdoor unit and the farthest indoor unit tops at 250 meters, a best-in-class for the industry.



**Farthest equivalent length
250 m**

3 Height between outdoor unit and indoor unit

Another industry best-in-class feature is the maximum vertical distance between the outdoor and indoor units, which can extend up to 110 meters. Toshiba's VRF enhanced piping capabilities results in more benefits for system design and installation flexibility, as well as lower installation costs.



**Height difference between outdoor unit and indoor unit
40 m**

4 Height difference FCU-FCU

Maximum vertical distance between indoor units, which reaches up to 40 meters, equal to an entire 11-storey building.

> Toshiba selection tool

Designed for novice and expert users, Toshiba selection software creates simple, yet detailed VRF system schematics. It is highly versatile, allowing the level of detail to be tailored to suit customer requirements. Final detailed reports can be produced and sent to customers in PDF format or in more complex files, such as AutoCAD DXF, allowing simple integration into existing software packages.



> Easy commissioning and maintenance

Save time during commissioning and maintenance. Choose between the "Wave Tool Advance" using Smartphone NFC connection or the link adaptor connected to the outdoor or indoor unit.

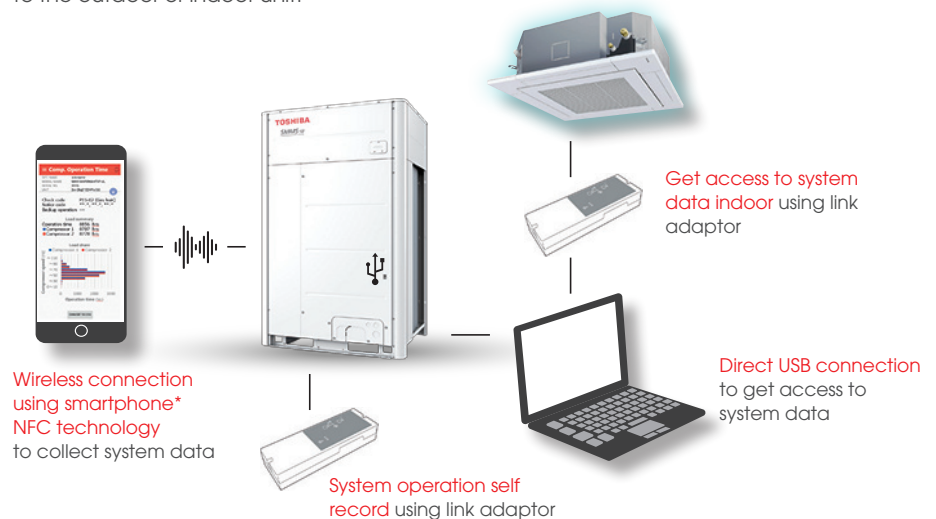

* Please contact Toshiba for Android® phone compatibility list.

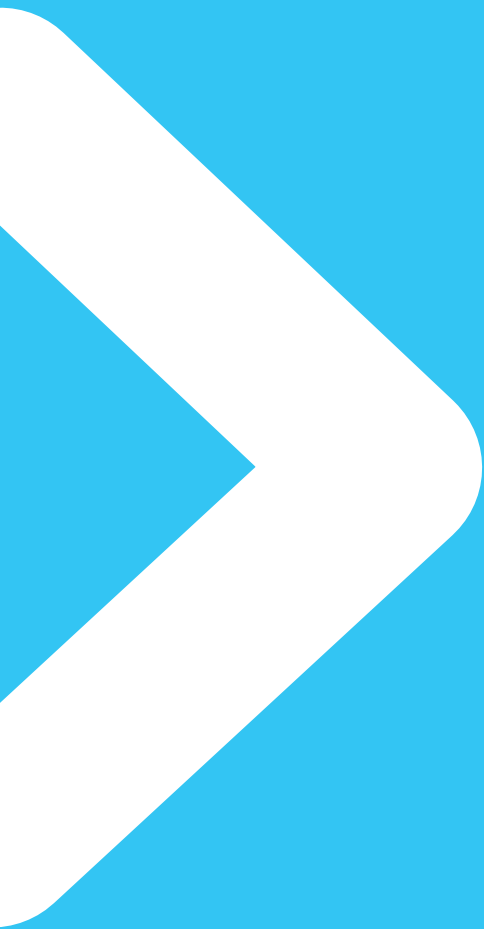

EUROPE

CHOOSE YOUR ADAPTED SYSTEM SOLUTION

MAPPING BY APPLICATIONS

OUTDOOR UNITS

Residential



Light commercial



Business









	Residential	Light commercial	Business
Reversible cooling or heating	 Mini SMMS Sideblow 1 fan & 2 fans	Individual housing mainly Up to 250 m ² per system Max. 10 IDUs per system	Up to 250 m ² per system and max. 10 IDUs per system 1 phase electrical power supply only
	 Mini SMMS-e 1Ph & 3Ph	Individual housing mainly	Up to 400 m ² per system Max. 16 IDUs per system
	 Stand alone SMMS-e, SMMS-e & SMMS-u	Collective housing mainly 3-phase electrical power supply only	Up to 6,000 m ² per system Max. 128 IDUs per system
Simultaneous cooling & heating	 SHRM-e	Collective housing mainly 3-phase electrical power supply only	Up to 2,500 m ² per system Max. 64 IDUs per system Hot water production capability

INDOOR UNITS

	Residential	Light commercial	Business
Cassette		o (4-way standard or compact)	o (All types)
Duct	o (Standard duct)	o (Standard or high static pressure)	o (Slim or standard)
High-wall	o	o	o
Ceiling		o	o (Slim for rooms & standard for lobby)
Console	o (Bi-flow version)		o (For lobby)

The data provided on this page is for informational purposes only and not for the purpose of providing legal or other professional advice.

CHOOSE YOUR ADAPTED SYSTEM SOLUTION

OUTDOOR UNIT MAPPING FOR EUROPE												
												
		R410A	R410A	R410A	R410A			R410A		R410A		
		MCY-MHP0_4HT-E	MCY-MHP0_4HS-E	MCY-MHP0_4HS8-E	MMY-SAP_6HT8P-E	MMY-MAP_6HT8P-E		MMY-MUP_1HT8P-E	MMY-MAP_6FT8P-E			
		Heat pump			Heat pump	Heat pump			Heat pump		Heat pump	
					Single module /stand alone	Single module	Standard combinations	High efficiency / High capacity combination	Single module	Standard combinations	Single module	Combinations
4		●▼	●▼	●▼								
5		●▼	●▼	●▼								
6		●▼	●▼	●▼								
8				●▼	●▼	●▼		●▼		●▼		
10				●▼	●▼	●▼		●▼		●▼	●▼	
12					●▼	●▼		●▼		●▼	●▼	
14						●▼		●▼		●▼	●▼	
16						●▼		●▼	●	●▼	●▼	
18						●▼		●▼	●	●▼	●▼	
20						●▼	●	●▼	●	●▼	●▼	
22						●▼	●	●▼	●	●	●	
24							●	●▼	●	●	●	
26							●	●	●	●	●	
28							●	●	●	●	●	
30							●	●	●	●	●	
32							●	●	●	●	●	
34							●	●	●	●	●	
36							●	●	●	●	●	
38							●	●	●	●	●	
40							●	●	●	●	●	
42							●	●	●	●	●	
44							●	●	●	●	●	
46							●	●	●	●	●	
48							●	●	●	●	●	
50							●	●	●	●	●	
52							●	●	●	●	●	
54							●	●	●	●	●	
56							●	●	●	●	●	
58							●	●	●	●	●	
60							●	●	●	●	●	
...								●	●	●	●	
120									●	●	●	
Fresh air solution	Fresh air duct						●	●	●	●	●	
	Air to Air heat exchanger + DX coil		●	● (4, 5 and 6HP only)			●	●	●		●	
	Standard DX Kit	●	●	●			●	●	●	●	●	
	0/10v DX kit						● (6, 8 and 10HP only)					
Hot water	Hot water module			● (8 and 10HP only)			●	●	●	●	●	
Small capacity indoor units	0.3HP indoor unit								●	●		
	0.6HP indoor unit (4 and 5HP only)	●	●	●	●	●	●	●	●	●	●	
Accessories	Leak detection	●	●	●	●	●	●	●	●	●	●	
	Leak detection with pump down		●	● (4, 5 and 6HP only)	●	●	●	●		●	●	

●:Heat pump - ▼:Eurovent certified 

MCY-MHP_HT
SIDE BLOW



Compact, efficient, adaptable, energy saver, the sideblow VRF is the solution to cool and heat small/medium size buildings.

Efficiency

- Toshiba's in-house designed twin rotary inverter controlled compressor operates precisely to match the indoor demand, providing class leading levels of performance and system efficiency.

Adaptability

- Extensive indoor model range, with various styles of indoor unit designs, including small capacity 0.6Hp models.
- Possibility to merge different styles of indoor units.

Comfort

- One user-friendly controller for all the indoor units helps to simplify the unit control.

SCOP MAX 4.21	CAPACITY 4HP > 6HP	OPERATION -20°C > +46°C
-----------------------------	-------------------------------------	--

For 4 and 5HP, outdoor unit height greatly reduced (>1m) for easier integration and installation.

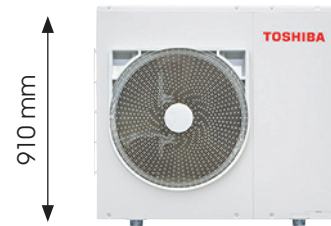

SIDE BLOW Performances

Outdoor unit	HP	MCY-MHP0406HT-E	MCY-MHP0506HT-E1	MCY-MHP0604HT-E
Cooling capacity	kW	4 HP	5 HP	6 HP
Cooling capacity		12.1	14.0	15.5
Power input	kW C	3.73	4.33	4.35
EER	W/W	3.24	3.23	3.56
EthasC/SEER		320.2% / 8.08	307.8% / 7.77	365.4% / 9.21
Running current	A C	14.4 / 13.8 / 13.2	20.8 / 19.9 / 19	20.6 / 19.7 / 18.9
Heating capacity	kW	12.5	16.0	18.0
Power input	kW H	2.83	4.00	4.50
COP	W/W	4.42	4.00	4.00
EthasH/SCOP		150.2% / 3.83	152.2% / 3.88	165.4% / 4.21
Running current	A H	13.4 / 12.8 / 12.3	19.1 / 18.3 / 17.5	21.3 / 20.4 / 19.5
Peak demand current	A	26.5	28.0	28.0

SIDE BLOW Physical data

Outdoor unit	HP	MCY-MHP0406HT-E	MCY-MHP0506HT-E	MCY-MHP0604HT-E
Air flow	m³/h - l/s	4020 - 1116	4260 - 1183	6410 - 1781
Sound pressure level	dB(A) C/H	54/57	54/58	52/55
Max indoor connectivity		8	10	6
Dimensions (HxWxD)	mm	910 x 990 x 390	910 x 990 x 390	1235 x 990 x 390
Weight	kg	100	100	116
Compressor type		Twin Rotary	Twin Rotary	Twin Rotary
Refrigerant charge R410A	kg/TCO2eq	3.3/6.9	3.3/6.9	3.9/8.1
Gas line type - diameter		Flare - 5/8"	Flare - 5/8"	Flare - 3/4"
Liquid line type - diameter		Flare - 3/8"	Flare - 3/8"	Flare - 3/8"
Discharge line connection type - diameter				
Maximum equivalent length separation*	m	60	60	60
Maximum actual piping separation*	m	50	50	50
Maximum total pipe length*	m	90	90	90
Maximum lift (indoor unit above/below)	m	15/15	15/15	15/15
Operating range - db	°C C	-5/46	-5/46	-5/43
Operating range - wb	°C H	-20/15	-20/15	-20/15
Power supply	V-ph-Hz	220 / 230 / 240-1-50	220 / 230 / 240-1-50	220 / 230 / 240-1-50

* when PMV Kit is used: Maximum equivalent length separation (50 m); Maximum actual piping separation (40 m); Maximum total pipe length (75 m)
C: cooling mode
H: heating mode

MCY-MHP_HS
Mini SMMS-e 1Ph



Incorporating all of Toshiba's VRF experience and knowledge into a system that measures no more than 1.2m high, results in a perfect solution for all small to medium building heating and cooling requirements.

Technology

- Toshiba's in-house designed twin rotary inverter controlled compressor operates precisely to match the indoor demand, providing class leading levels of performance and system efficiency.
- Precise refrigerant control ensures each indoor unit receives the right amount of refrigerant.

Connectivity

- With 180m total (125m equivalent) piping length, ensures the MiNi SMMS-e system is adaptable for all types of projects.
- Extensive indoor model range, with various styles of indoor unit designs, including small capacity (0.6Hp) and air-to-air heat exchanger models.

SCOP MAX



4.37

CAPACITY



4HP > 6HP

OPERATION



-20°C > +46°C

Toshiba's in-house designed twin rotary inverter controlled compressor operates precisely to match the indoor demand, providing class leading levels of performance and system efficiency.

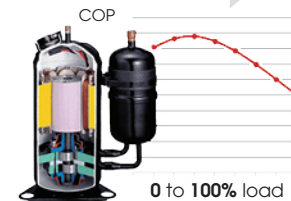

MiNi SMMS-e 1Ph Performances

Outdoor unit	HP	MCY-MHP0404HS-E	MCY-MHP0504HS-E	MCY-MHP0604HS-E
		4 HP	5 HP	6 HP
Cooling capacity	kW	12.1	14.0	15.5
Power input	kW C	2.83	3.50	4.29
EER	W/W	4.28	4.00	3.61
EthasC/SEER		373.8% / 9.42	366.2% / 9.23	384.2% / 9.68
Running current	A C	13.5 / 13.0 / 12.4	16.6 / 15.9 / 15.2	20.1 / 19.2 / 18.4
Heating capacity	kW	12.5	16.0	18.0
Power input	kW H	2.59	3.75	4.31
COP	W/W	4.83	4.27	4.18
EthasH/SCOP		163.8% / 4.17	166.6% / 4.24	171.8% / 4.37
Running current	A H	12.5 / 12.0 / 11.5	17.8 / 19.3 / 18.5	20.2 / 19.3 / 18.5

MiNi SMMS-e 1Ph Physical data

Outdoor unit	HP	MCY-MHP0404HS-E	MCY-MHP0504HS-E	MCY-MHP0604HS-E
Air flow	m³/h - l/s	5660 - 1572	5820 - 1617	6050 - 1681
Sound pressure level	dB(A) C/H	49/52	50/53	51/54
Max indoor connectivity		8	10	13
Dimensions (HxWxD)	mm	1235 x 990 x 390	1235 x 990 x 390	1235 x 990 x 390
Weight	kg	127	127	127
Compressor type		Hermetic Twin Rotary	Hermetic Twin Rotary	Hermetic Twin Rotary
Refrigerant charge R410A	kg/TCO2eq	6.4 / 13.4	6.4 / 13.4	6.4 / 13.4
Gas line type - diameter		Flare - 5/8"	Flare - 5/8"	Flare - 3/4"
Liquid line type - diameter		Flare - 3/8"	Flare - 3/8"	Flare - 3/8"
Discharge line connection type - diameter				
Maximum equivalent length separation*	m	125	125	125
Maximum actual piping separation*	m	100	100	100
Maximum total pipe length*	m	180	180	180
Maximum lift (indoor unit above/below)	m	20/30	20/30	20/30
Operating range - db	°C C	-5/46	-5/46	-5/46
Operating range - wb	°C H	-20.0 / 15.0	-20.0 / 15.0	-20.0 / 15.0
Power supply	V-ph-Hz	220 / 230 / 240-1-50	220 / 230 / 240-1-50	220 / 230 / 240-1-50

* when PMV Kit is used: Maximum equivalent length separation (80 m); Maximum actual piping separation (65 m); Maximum total pipe length (150 m)
Note: Use engineering Data Book for specific details.
C: cooling mode - H: heating mode

MCY-MHP_HS8
MiNi SMMS-e 3Ph



Incorporating all of Toshiba's VRF experience and knowledge into a system that measures no more than 1.2m high, results in a perfect solution for all small to medium building heating and cooling requirements.

Technology

- Toshiba's in-house designed twin rotary inverter controlled compressor operates precisely to match the indoor demand, providing class leading levels of performance and system efficiency.
- Precise refrigerant control ensures each indoor unit receives the right amount of refrigerant.

Connectivity

- With 180m total (125m equivalent) piping length, ensures the MiNi SMMS-e system is adaptable for all types of projects.
- Extensive indoor model range, with various styles of indoor unit designs, including small capacity (0.6Hp) and air-to-water heat exchanger models.
- 3Ph power supply.

SCOP MAX



4.38

CAPACITY



4HP > 10HP

OPERATION



-20°C > +46°C

With 30Pa available pressure, the MiNi SMMS-e can be installed indoor behind a transfer grid.



MiNi SMMS-e 3Ph Performances

Outdoor unit	HP		MCY-MHP0404HS8-E		MCY-MHP0504HS8-E	MCY-MHP0604HS8-E	MCY-MHP0806HS8-E	MCY-MHP1006HS8-E
			4 HP	5 HP	6 HP	8 HP	10 HP	
Cooling capacity		kW	12.1	14.0	15.5	22.4	28	
Power input	C	kW	2.82	3.47	4.25	6.67	9.34	
EER		W/W	4.29	4.03	3.65	3.36	3.00	
EthasC/SEER		W/W	375.8% / 9.47	368.6% / 9.29	386.6% / 9.74	320.6% / 8.09	293.0% / 7.40	
Running current	C	A	4.8 / 4.5 / 4.4	5.7 / 5.4 / 5.2	7.0 / 6.7 / 6.4	11.1 / 10.6 / 10.2	15.3 / 14.5 / 14.0	
Heating capacity		kW	12.5	16.0	18.0	22.4	28.0	
Power input	H	kW	2.57	3.72	4.27	5.20	7.00	
COP		W/W	4.86	4.30	4.22	4.31	4.00	
EthasH/SCOP			164.6% / 4.19	167.0% / 4.25	172.2% / 4.38	177.0% / 4.50	179.8% / 4.57	
Running current	H	A	4.4 / 4.2 / 4.0	6.1 / 5.8 / 5.6	7.0 / 6.6 / 6.4	8.7 / 8.2 / 7.9	11.4 / 10.9 / 10.5	

MiNi SMMS-e 3Ph Physical data

Outdoor unit	HP		MCY-MHP0404HS8-E	MCY-MHP0504HS8-E	MCY-MHP0604HS8-E	MCY-MHP0804HS8-E	MCY-MHP1004HS8-E
Air Flow		m³/h - l/s	5660 - 1572	5820 - 1617	6050 - 1681	8460-2350	8820-2450
Sound pressure level	C/H	dB(A)	49 / 52	50 / 53	51 / 54	58 / 59	59 / 60
Dimensions (HxWxD)		mm	1235 x 990 x 390	1235 x 990 x 390	1235 x 990 x 390	1740 x 990 x 390	1740 x 990 x 390
Weight		kg	125	125	125	147	147
Compressor type			Hermetic Twin Rotary	Hermetic Twin Rotary	Hermetic Twin Rotary	Hermetic Twin Rotary	Hermetic Twin Rotary
Refrigerant charge R410A		kg/TCO2eq	6.4 / 13.4	6.4 / 13.4	6.4 / 13.4	4.4 / 9.2	4.4 / 9.2
Gas line type - diameter			Flare - 5/8"	Flare - 5/8"	Flare - 3/4"	Flare 3/4	Flare 3/4
Liquid line type - diameter			Flare - 3/8"	Flare - 3/8"	Flare - 3/8"	Flare 3/8(*2)	Flare 3/8(*2)
Discharge line connection type - diameter							
Maximum equivalent length separation*		m	125	125	125	150	150
Maximum actual piping separation*		m	100	100	100	120	120
Maximum total pipe length*		m	180	180	180	300	300
Maximum lift (indoor unit above/below)		m	20/30	20/30	20/30	30	30
Operating range - db	C	°C	-5/46	-5/46	-5/46	-5/46	-5/46
Operating range - wb	H	°C	-20.0 / 15.0	-20.0 / 15.0	-20.0 / 15.0	-20.0 / 15.0	-20.0 / 15.0
Power supply		V-ph-Hz	380 / 400 / 415-3-50	380 / 400 / 415-3-50	380 / 400 / 415-3-50	380 / 400 / 415-3-50	380 / 400 / 415-3-50

* when PMV Kit is used: Maximum equivalent length separation (80 m); Maximum actual piping separation (65 m); Maximum total pipe length (150 m)
 *2 Need to expand to 1/2" under certain condition.
 C: cooling mode - H: heating mode

MMY-SAP_HT8P
SMMS-E STAND ALONE



Keep all benefits of Toshiba SMMS-e with 50% less pre-charge refrigerant: new intelligent and innovative features that maximise end user comfort and system efficiencies.

Excellence

- Toshiba's in-house designed DC twin rotary compressor offers outstanding capacity, efficiency and comfort even under part load conditions.
- Incorporating Toshiba's latest inverter control for compressor precise regulation, maximum performance and energy savings.
- Outstanding 4-side heat exchanger + sub cooling heat exchanger for optimized efficiency
- Precise refrigerant control to ensure that each indoor unit receives exactly the right amount of refrigerant.

Expansion

- A wide choice of indoor unit styles and capacity ranges to match customer needs and room configurations.

Enhancement

- With up to 235 m in equivalent length, 90 m from the first branch kit to the farthest indoor unit and 70 m height difference, the system is fully adaptable to all project types.

MAX EFFICIENCY



CAPACITY



8HP > 12HP

OPERATION



-25°C > +46°C

For maximum peace of mind should a compressor failure occur, backup operation is available.

The ALL inverter control can be adjusted to compensate for a failed compressor.

SMMS-E STAND ALONE Performances

Outdoor unit	HP	MMY-	SAP0806HT8P-E 8 HP	SAP1006HT8P-E 10 HP	SAP1206HT8P-E 12 HP
Cooling capacity¹	kW		22,4	28,0	33,5
Power input	kW	C	5,54	7,91	10,31
EER	W/W		4,04	3,54	3,25
EthasC/SEER			249,8% / 6,32	244,2% / 6,18	241% / 6,1
Running current	A	C	8,8	12,4	16,0
Heating capacity¹	kW		25,0	31,5	37,5
Power input	kW	H	5,66	7,59	9,76
COP	W/W		4,42	4,15	3,84
EthasH/SCOP			148,6% / 3,79	149,4% / 3,81	144,2% / 3,68
Running current	A	H	9,0	11,9	1,1
Maximum overcurrent protection ³	A		25	25	32

SMMS-E STAND ALONE Physical data

Outdoor unit	HP	MMY-	SAP0806HT8P-E	SAP1006HT8P-E	SAP1206HT8P-E
Air Flow	m ³ /h		9700	9700	12200
Air Flow	l/s		2694	2694	3389
Sound Power Level	dB(A)	H	74	74	82
Sound pressure level	dB(A)	H	56	58	61
Sound Power Level	dB(A)	C	74	74	80
Sound pressure level	dB(A)	C	55	57	59
External Static pressure available	Pa		60	60	50
Dimensions (h x w x d)	mm		1830 x 990 x 780	1830 x 990 x 780	1830 x 990 x 780
Weight	kg	HP	227	227	227
Compressor type			Hermetic Twin Rotary	Hermetic Twin Rotary	Hermetic Twin Rotary
Refrigerant charge R410A	kg/TCO ₂ eq		5,7 / 11,9	5,7 / 11,9	5,7 / 11,9
Gas line type - diameter			Brazed - 3/4"	Brazed - 7/8"	Brazed - 1-1/8"
Liquid line type - diameter			Flare - 1/2"	Flare - 1/2"	Flare - 1/2"
Farthest piping equivalent length	m		235	235	235
Farthest piping actual length	m		190	190	190
Maximum pipe length ⁴	m		300	300	300
Maximum lift (indoor unit above/below) ^{5,2}	m		40 / 70	40 / 70	40 / 70
Operating range - db ^{3,4}	°C	C	-10 / 46	-10 / 46	-10 / 46
Operating range - wb ^{7,5,6}	°C	H	-25 / 15,5	-25 / 15,5	-25 / 15,5
Power supply	V-ph-Hz		380 / 415-3-50	380 / 415-3-50	380 / 415-3-50

1) Rated conditions
Cooling : Indoor 27 degC Dry Bulb /19 degC Wet Bulb , Outdoor 35 degC Dry Bulb. Heating : Indoor 20 degC Dry Bulb, Outdoor 7 degC Dry Bulb / 6 degC WetBulb. Based on equivalent piping length of 7.5m and piping height difference of 0m. 2) Indoor above condition: If the height difference between indoor units exceeds 3 m, set 30 m or less. Indoor below condition: If the height difference between indoor units exceeds 3 m, set 50 m or less. Also Extension up till 90m is possible. Be sure to refer the Engineering Databook for details of these conditions and requirements. 3) The unit operates down to an outdoor temperature of -10°C, however cooling performance may decline considerably when total operating capacity of indoor units is less than 4HP while ambient temperature is below -5°C. Consider installation location/surroundings and system design when expected to operate below -5°C. 4) Low ambient cooling (-5 deg C or less) is limited to application. 5) The unit operates down to an outdoor temperature of -25°C, however considerable performance decrease will be expected below -20°C. Consider installation location/surroundings and system design when expected to operate between -20°C and -25°C. 6) Low ambient heating (-20degC or less) for extended periods of time is not allowed.
C: cooling mode - H: heating mode

MMY-MUP_1HT8P
SMMS-u



> NEW



SMMS-u, the latest generation of Toshiba VRF engineered in Japan, integrates a totally new redesigned chassis, a new compressor and a new heat exchanger to achieve unrivalled efficiency, outstanding comfort level and low environmental footprint.

Unrivalled

- Space efficient chassis design to ease product integration with no compromise on efficiency.
- Exclusive Toshiba Triple rotary compressor offering high capacity, outstanding performances with less refrigerant.
- Super efficient heat exchanger covering full product height to maximize energy exchange.
- Intelligent VRF control ensures exact quantity of refrigerant to be delivered to the indoor units to avoid waste of energy.
- KO-BE-TSU and Renkey new defrost solution for constant comfort level.

Universal

- Up to 24HP in single module and max 120HP in combination, enter into a new dimension!
- Up to 1,200m piping length max to cover the full building without splitting systems.
- Less constraints with 128 indoor units maximum per system.
- -25 to +52°C operating range to cover all climates over Europe.

Usability

- Ease commissioning and maintenance with direct USB connection, Wave Tool advance and Link adaptor.
- Trust into the new TU2C link protocol offering faster and stronger data transfer.

SCOP MAX



4.79

CAPACITY



8HP > 24HP

OPERATION



-25°C > +52°C

The exclusive Toshiba triple rotary compressor brings outstanding performances to the SMMS-u with no compromise on system reliability.



Triple rotary compressor

SMMS-u Physical data

Outdoor unit		MMY- MUP0801HT8P-E	MUP1001HT8P-E	MUP1201HT8P-E	MUP1401HT8P-E	MUP1601HT8P-E	MUP1801HT8P-E	MUP2001HT8P-E	MUP2201HT8P-E	MUP2401HT8P-E
Air Flow	m³/h	9900	10500	11700	11880	15300	16800	15900	16500	16500
Sound Power Level	dB(A) H	75	77	79	79	83	84	86	86	86
Sound pressure level	dB(A) H	53	55	58	58	60	61	63	63	63
Sound Power Level	dB(A) C	76	77	81	82	86	89	90	90	90
Sound pressure level	dB(A) C	56	58	62	62	63	67	67	67	67
External Static pressure available	Pa	80	80	80	80	80	80	80	80	80
Dimensions (h x w x d)	mm	1690x990x780	1690x990x780	1690x990x780	1690x990x780	1690x1290x780	1690x1290x780	1690x1290x780	1690x1290x780	1690x1290x780
Weight	kg	228	228	228	228	312	312	334	356	356
Compressor type		Hermetic Twin Rotary	Hermetic Twin Rotary	Hermetic Twin Rotary	Hermetic Twin Rotary	Hermetic Triple Rotary	Hermetic Triple Rotary	Hermetic Triple Rotary	Hermetic Twin Rotary	Hermetic Twin Rotary
Refrigerant charge R410A	kg	6,0	6,0	6,0	6,0	9,0	9,0	9,0	9,0	9,0
	TCO2eq	12,5	12,5	12,5	12,5	18,8	18,8	18,8	18,8	18,8
Gas line type - diameter		Brazed - 3/4"	Brazed - 7/8"	Brazed - 1 1/8"	Brazed - 1 1/8"	Brazed - 1 1/8"	Brazed - 1 1/8"	Brazed - 1 1/8"	Brazed - 1 1/8"	Brazed - 1 3/8"
Liquid line type - diameter		Brazed - 1/2"	Brazed - 1/2"	Brazed - 1/2"	Brazed - 5/8"	Brazed - 5/8"	Brazed - 5/8"	Brazed - 5/8"	Brazed - 3/4"	Brazed - 3/4"
Farthest piping equivalent length	m	250	250	250	250	250	250	250	250	250
Farthest piping actual length	m	210	210	210	210	210	210	210	210	210
Maximum pipe length ³	m	500	500	500	500	500	500	500	500	500
Maximum lift (indoor unit above/below) ^{4,5}	m	110/110	110/110	110/110	110/110	110/110	110/110	110/110	110/110	110/110
Operating range - db6,7	°C C	-10/52	-10/52	-10/52	-10/52	-10/52	-10/52	-10/52	-10/52	-10/52
Operating range - wb8,9	°C H	-25/15,5	-25/15,5	-25/15,5	-25/15,5	-25/15,5	-25/15,5	-25/15,5	-25/15,5	-25/15,5
Power supply	V-ph-Hz	380/415-3-50	380/415-3-50	380/415-3-50	380/415-3-50	380/415-3-50	380/415-3-50	380/415-3-50	380/415-3-50	380/415-3-50

Models for Turkey : MMY-MUP_1HT8P-TR

































SMMS-u

SMMS-u Performances

Outdoor unit		MMY-MUP0801HT8P-E	MUP1001HT8P-E	MUP1201HT8P-E	MUP1401HT8P-E	MUP1601HT8P-E	MUP1801HT8P-E	MUP2001HT8P-E	MUP2201HT8P-E	MUP2401HT8P-E
		8 HP	10 HP	12 HP	14 HP	16 HP	18 HP	20 HP	22 HP	24HP
Cooling capacity¹	kW	22,40	28,00	33,50	40,00	45,00	50,40	56,00	61,50	67,00
Power input	kW C	5,64	8,36	10,34	14,55	14,06	15,90	18,01	20,43	24,19
EER	W/W	3,97	3,35	3,24	2,75	3,20	3,17	3,11	3,01	2,77
EthasC/SEER	W/W	294,6%/7,44	306,2%/7,73	289,8%/7,32	279,0%/7,05	305,4%/7,71	304,2%/7,68	301,8%/7,62	286,2%/7,23	271,8%/6,87
Running current	A C	9,15	13,40	16,00	22,60	21,60	24,40	27,70	31,40	37,10
Heating capacity rated/max	kW	22.4/25	28/31.5	33.5/37.5	40/45	45/50	50.4/56	56/63	61.5/69	67/70
Power input (rated)	kW H	5,28	7,20	7,77	10,00	11,94	12,54	14,93	16,18	18,98
COP	W/W	4,24	3,89	4,31	4,00	3,77	4,02	3,75	3,80	3,53
Ethash/SCOP		177,0%/4,5	188,2%/4,78	187,0%/4,75	181,0%/4,6	188,6%/4,79	187,0%/4,75	174,2%/4,43	174,6%/4,44	163,8%/4,17
Running current	A H	8,56	11,50	12,10	15,50	18,30	19,30	22,90	24,80	29,10
Maximum overcurrent protection ²	A	20,00	32,00	32,00	40	40	50	50,00	63	80,00

1) Rated conditions : Cooling : Indoor 27 degC Dry Bulb /19 degC Wet Bulb , Outdoor 35 degC Dry Bulb. Heating : Indoor 20 degC Dry Bulb, Outdoor 7 degC Dry Bulb / 6 degC WetBulb. Based on equivalent piping length of 7.5m and piping height difference of 0m. 2) If outdoor units are combined, refer to the installation manual. 3) Multiple outdoor systems : 1200m. Total charging refrigerant is 140kg or less. 4) Extension up till 110m (upper outdoor unit) is possible with conditions below :Single outdoor unit system. Connected ratio of indoor units to outdoor units is below 105%. Liquid side is below increased 1 size from the standard size. The height between indoor units (H2) is 3m or less. 5) Extension up till 110m (lower outdoor unit) is possible with conditions below : Multiple outdoor unit system. Connected ratio of indoor units to outdoor units is below 105%. Minimum capacity of connecting indoor unit is more than 3HP.The height between indoor units (H2) is 3m or less. 6) The unit operates down to an outdoor temperature of -10°C, however cooling performance may decline considerably when total operating capacity of indoor units is less than 4HP while ambient temperature is below -5°C. Consider installation location/ surroundings and system design when expected to operate below -5°C. On single outdoor unit only. No height difference between units. 7) Low ambient cooling (-5 deg C or less) is limited to application. 8) The unit operates down to an outdoor temperature of -25°C, however considerable performance decrease will be expected below -20°C. Consider installation location/surroundings and system design when expected to operate between -20°C and -25°C. 9) Low ambient heating (-20degC or less) for extended periods of time is not allowed. C = cooling mode. H = heating mode

SMMS-u Capacity table - Standard model

HP	Capacity		Combination	Modèle	EER/SEER	COP/SCOP	Max indoor connectivity	
	Cooling/Heating in kW							
8	22.4/22.4		8	MMY-MUP0801HT8P-E/TR	3.97/7.44	4.24/4.5	18	
10	28/28		10	MMY-MUP1001HT8P-E/TR	3.35/7.73	3.89/4.78	22	
12	33.5/33.5		12	MMY-MUP1201HT8P-E/TR	3.24/7.32	4.31/4.75	27	
14	40/40		14	MMY-MUP1401HT8P-E/TR	2.75/7.05	4/4.6	31	
16	45/45		16	MMY-MUP1601HT8P-E/TR	3.2/7.71	3.77/4.79	36	
18	50.4/40.5		18	MMY-MUP1801HT8P-E/TR	3.17/7.68	4.02/4.75	40	
20	56/56		20	MMY-MUP2001HT8P-E/TR	3.11/7.62	3.75/4.43	45	
22	61.5/61.5		22	MMY-MUP2201HT8P-E/TR	3.01/7.23	3.8/4.44	49	
24	67/67		24	MMY-MUP2401HT8P-E/TR	2.77/6.87	3.53/4.17	52	
26	73.5/73.5		14 + 12	MMY-UP2611HT8P-E/TR	2.95/4.17	4.14/4.67	58	
28	80/80		14 + 14	MMY-UP2811HT8P-E/TR	2.75/7.05	4/4.6	63	
30	83.9/83.9		18 + 12	MMY-UP3011HT8P-E/TR	3.2/7.52	4.13/4.75	64	
32	89.5/89.5		20 + 12	MMY-UP3211HT8P-E/TR	3.16/7.5	3.94/4.55	65	
34	96/96		20 + 14	MMY-UP3411HT8P-E/TR	2.95/7.35	3.85/4.5	66	
36	100.5/100.5		24 + 12	MMY-UP3611HT8P-E/TR	2.91/7.01	3.76/4.38	67	
38	107/107		24 + 14	MMY-UP3811HT8P-E/TR	2.76/6.93	3.69/4.33	68	
40	112/112		20 + 20	MMY-UP4011HT8P-E/TR	3.11/7.62	3.75/4.43	69	
42	117.4/117.4		24 + 18	MMY-UP4211HT8P-E/TR	2.93/7.22	3.72/4.43	70	
44	123/123		24 + 20	MMY-UP4411HT8P-E/TR	2.91/7.21	3.63/4.3	71	
46	128.5/128.5		24 + 22	MMY-UP4611HT8P-E/TR	2.88/7.04	3.65/4.31	72	
48	134/134		24 + 24	MMY-UP4811HT8P-E/TR	2.77/6.87	3.53/4.17	73	
50	140.5/140.5		24 + 14 + 12	MMY-UP5011HT8P-E/TR	2.86/7.02	3.82/4.44	74	
52	147/147		24 + 14 + 14	MMY-UP5211HT8P-E/TR	2.76/6.96	3.77/4.41	75	
54	152/152		20 + 20 + 14	MMY-UP5411HT8P-E/TR	3.01/7.49	3.81/4.47	76	
56	156.5/156.5		24 + 20 + 12	MMY-UP5611HT8P-E/TR	2.98/7.23	3.75/4.41	77	
58	163/163		24 + 20 + 14	MMY-UP5811HT8P-E/TR	2.87/7.19	3.71/4.37	78	
60	167.5/167.5		24 + 24 + 12	MMY-UP6011HT8P-E/TR	2.85/6.95	3.66/4.3	79	
62	174/174		24 + 24 + 14	MMY-UP6211HT8P-E/TR	2.76/6.92	3.63/4.27	80	
64	179/179		24 + 20 + 20	MMY-UP6411HT8P-E/TR	2.97/7.34	3.67/4.34	81	
66	184.5/184.5		24 + 22 + 20	MMY-UP6611HT8P-E/TR	2.95/7.21	3.68/4.35	82	
68	190/190		24 + 24 + 20	MMY-UP6811HT8P-E/TR	2.86/7.09	3.59/4.26	83	
70	195.5/195.5		24 + 24 + 22	MMY-UP7011HT8P-E/TR	2.84/6.98	3.61/4.26	84	
72	201/201		24 + 24 + 24	MMY-UP7211HT8P-E/TR	2.77/6.87	3.53/4.17	85	
74	207.5/207.5		24 + 24 + 14 + 12	MMY-UP7411HT8P-E/TR	2.83/6.97	3.72/4.36	86	
76	214/214		24 + 24 + 14 + 14	MMY-UP7611HT8P-E/TR	2.76/6.93	3.69/4.33	87	
78	219/219		24 + 20 + 20 + 14	MMY-UP7811HT8P-E/TR	2.93/7.3	3.72/4.39	88	
80	223.5/223.5		24 + 24 + 20 + 12	MMY-UP8011HT8P-E/TR	2.91/7.14	3.68/4.34	90	
82	230/230		24 + 24 + 20 + 14	MMY-UP8211HT8P-E/TR	2.84/7.1	3.66/4.32	92	
84	234.5/234.5		24 + 24 + 24 + 12	MMY-UP8411HT8P-E/TR	2.83/6.95	3.62/4.26	94	
86	241/241		24 + 24 + 24 + 14	MMY-UP8611HT8P-E/TR	2.77/6.91	3.6/4.25	96	
88	246/246		24 + 24 + 20 + 20	MMY-UP8811HT8P-E/TR	2.91/7.21	3.63/4.3	98	
90	251.5/251.5		24 + 24 + 22 + 20	MMY-UP9011HT8P-E/TR	2.97/7.12	3.64/4.3	100	
92	257/257		24 + 24 + 24 + 20	MMY-UP9211HT8P-E/TR	2.84/7.03	3.58/4.24	102	
94	262.5/262.5		24 + 24 + 24 + 22	MMY-UP9411HT8P-E/TR	2.82/6.95	3.59/4.24	104	
96	268/268		24 + 24 + 24 + 24	MMY-UP9611HT8P-E/TR	2.77/6.87	3.53/4.17	106	
98	274.5/274.5		24 + 24 + 24 + 14 + 12	MMY-UP9811HT8P-E/TR	2.82/6.95	3.67/4.31	108	
100	281/281		24 + 24 + 24 + 14 + 14	MMY-UP10011HT8P-E/TR	2.76/6.94	3.65/4.3	110	
102	286/286		24 + 24 + 20 + 20 + 14	MMY-UP10211HT8P-E/TR	2.89/7.2	3.68/4.34	112	
104	290.5/290.5		24 + 24 + 24 + 20 + 12	MMY-UP10411HT8P-E/TR	2.88/7.08	3.65/4.3	114	
106	297/297		24 + 24 + 24 + 20 + 14	MMY-UP10611HT8P-E/TR	2.83/7.04	3.63/4.29	116	
108	301.5/301.5		24 + 24 + 24 + 24 + 12	MMY-UP10811HT8P-E/TR	2.82/6.93	3.6/4.24	118	
110	308/308		24 + 24 + 24 + 24 + 14	MMY-UP11011HT8P-E/TR	2.77/6.9	3.58/4.23	120	
112	313/313		24 + 24 + 24 + 20 + 20	MMY-UP11211HT8P-E/TR	2.88/7.13	3.61/4.28	122	
114	318.5/318.5		24 + 24 + 24 + 22 + 20	MMY-UP11411HT8P-E/TR	2.87/7.07	3.62/4.28	124	
116	324/324		24 + 24 + 24 + 24 + 20	MMY-UP11611HT8P-E/TR	2.82/7	3.57/4.22	126	
118	329.5/329.5		24 + 24 + 24 + 24 + 22	MMY-UP11811HT8P-E/TR	2.81/6.93	3.58/4.23	128	
120	335/335		24 + 24 + 24 + 24 + 24	MMY-UP12011HT8P-E/TR	2.77/6.87	3.53/4.17	128	

Models for Turkey : MMY-MUP_1HT8P-TR

MMY-MAP_HT8P SMMS-e



SMMS-e includes many intelligent and innovative features that maximise end user comfort and system efficiencies.

Excellence

- Toshiba's in-house designed DC twin rotary compressor with outstanding capacity under partial load driven to improve efficiency and comfort.
- Incorporating Toshiba's latest inverter control, enables the precise modulation of the compressor, ensuring maximum performance and energy savings.
- 2 heat exchangers: outstanding 4-side heat exchanger + sub cooling heat exchanger to optimize efficiency.
- Precise refrigerant control ensures each indoor unit receives precisely the right amount of refrigerant.

Expansion

- 8 outdoor unit model line-up that can be installed in a variety of combinations, of up to a capacity of 60 HP.
- A complete range of indoor unit styles and capacity ranges, meets the demands of the customer and the room configuration.

Enhancement

- With up to 1km total piping length; 235m in equivalent length and 70m of height difference, the system is fully adaptable for all types of projects.
- Revolutionary hands-free Wave Tool technology that allows contactless commissioning and diagnoses to be carried out using a smartphone application.

SCOP MAX



3.70

CAPACITY



8HP > 60HP

OPERATION



-25°C > +46°C

Toshiba's continuous heating function helps to maintain the indoor room temperature and end user comfort.

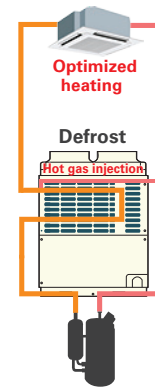

SMMS-e Physical data

Outdoor unit	CO	MMY-	MAP0806T8P-E/TR	MAP1006T8P-E/TR	MAP1206T8P-E/TR	MAP1406T8P-E/TR	MAP1606T8P-E/TR	MAP1806T8P-E/TR	MAP2006T8P-E/TR	MAP2206T8P-E/TR
Outdoor unit	HP	MMY-	MAP0806HT8P-E/TR	MAP1006HT8P-E/TR	MAP1206HT8P-E/TR	MAP1406HT8P-E/TR	MAP1606HT8P-E/TR	MAP1806HT8P-E/TR	MAP2006HT8P-E/TR	MAP2206HT8P-E/TR
Air flow	m ³ /h		9700	9700	12200	12200	12600	17300	17900	18500
Air flow	l/s		2694	2694	3389	3389	3500	4806	4972	5139
Sound Power Level	dB(A)	H	74	74	82	82	83	83	84	84
Sound pressure level	dB(A)	H	56	58	61	62	64	61	62	62
Sound Power Level	dB(A)	C	74	74	80	80	81	81	82	83
Sound pressure level	dB(A)	C	55	57	59	60	62	60	61	61
External Static pressure available	Pa		60	60	50	50	40	50	40	40
Dimensions (h x w x d)	mm		1830x990x780	1830x990x780	1830x990x780	1830x1210x780	1830x1210x780	1830x1600x780	1830x1600x780	1830x1600x780
Weight	kg	HP	242	242	242	300	300	371	371	371
	kg	CO	241	241	241	299	299	370	370	370
Compressor type			Hermetic Twin Rotary	Hermetic Twin Rotary	Hermetic Twin Rotary	Hermetic Twin Rotary	Hermetic Twin Rotary	Hermetic Twin Rotary	Hermetic Twin Rotary	Hermetic Twin Rotary
Refrigerant charge R410A	kg/TCO2eq	HP	11.5/24	11.5/24	11.5/24	11.5/24	11.5/24	11.5/24	11.5/24	11.5/24
		CO	10.5/21.9	10.5/21.9	10.5/21.9	10.5/21.9	10.5/21.9	10.5/21.9	10.5/21.9	10.5/21.9
Gas line type - diameter			Brazed - 3/4"	Brazed - 7/8"	Brazed - 1-1/8"	Brazed - 1-1/8"	Brazed - 1-1/8"	Brazed - 1-1/8"	Brazed - 1-1/8"	Brazed - 1-1/8"
Liquid line type - diameter			Flare - 1/2"	Flare - 1/2"	Flare - 1/2"	Flare - 5/8" or 1/2"	Flare - 5/8" or 1/2"	Flare - 5/8" or 1/2"	Flare - 5/8" or 1/2"	Flare - 3/4" or 5/8"
Farthest piping equivalent length	m		235	235	235	235	235	235	235	235
Farthest piping actual length	m		190	190	190	190	190	190	190	190
Maximum pipe length ³	m		1000	1000	1000	1000	1000	1000	1000	1000
Maximum lift (indoor unit above/below) ⁴	m		40/70	40/70	40/70	40/70	40/70	40/70	40/70	40/70
Operating range - db ^{5,6}	°C	C	-10/46	-10/46	-10/46	-10/46	-10/46	-10/46	-10/46	-10/46
Operating range - wb ^{7,8}	°C	H	-25/15.5	-25/15.5	-25/15.5	-25/15.5	-25/15.5	-25/15.5	-25/15.5	-25/15.5
Power supply	V-ph-Hz		380/415-3-50	380/415-3-50	380/415-3-50	380/415-3-50	380/415-3-50	380/415-3-50	380/415-3-50	380/415-3-50

SMMS-e Performances

Outdoor unit	CO	MMY- MAP0806T8P-E/TR	MAP1006T8P-E/TR	MAP1206T8P-E/TR	MAP1406T8P-E/TR	MAP1606T8P-E/TR	MAP1806T8P-E/TR	MAP2006T8P-E/TR	MAP2206T8P-E/TR
Outdoor unit	HP	MMY- MAP0806T8P-E/TR	MAP1006T8P-E/TR	MAP1206T8P-E/TR	MAP1406T8P-E/TR	MAP1606T8P-E/TR	MAP1806T8P-E/TR	MAP2006T8P-E/TR	MAP2206T8P-E/TR
		8 HP	10 HP	12 HP	14 HP	16 HP	18 HP	20 HP	22 HP
Cooling capacity¹⁾	kW	22.4	28.0	33.5	40.0	45.0	50.4	56.0	61.50
Power input	kW C	5.54	7.69	10.00	12.30	14.30	14.60	17.30	23.21
EER	W/W	4.04	3.64	3.35	3.25	3.15	3.45	3.24	2.65
EthasC/SEER	W/W	241.4% / 6.11	239.4% / 6.06	235% / 5.95	222.2% / 5.63	208.6% / 5.29	235.4% / 5.96	224.6% / 5.69	198.6% / 5.04
Running current	A C	8.8	12.1	15.5	19.5	22.4	22.9	26.8	35.6
Heating capacity¹⁾	kW	25.0	31.5	37.5	45.0	50.0	56.0	63.0	64.00
Power input	kW H	5.53	7.41	9.65	11.20	12.90	14.10	17.00	18.82
COP	W/W	4.52	4.25	3.89	4.02	3.88	3.96	3.71	3.40
EthasH/SCOP		142.6% / 3.64	138.2% / 3.53	143.4% / 3.66	139.8% / 3.57	145% / 3.7	140.6% / 3.59	140.6% / 3.59	136.6% / 3.49
Running current	A H	8.8	11.6	15.0	17.8	20.2	22.1	26.1	29.20
Max overcurrent protection ²⁾	A	25	25	32	40	40	50	63	63

1) Rated conditions Cooling: Indoor 27 degC Dry Bulb /19 degC Wet Bulb, Outdoor 35 degC Dry Bulb. Heating: Indoor 20 degC Dry Bulb, Outdoor 7 degC Dry Bulb / 6 degC WetBulb. Based on equivalent piping length of 7.5m and piping height difference of 0m. 2) If outdoor units are combined, refer to the installation manual. 3) Less than 34HP: 300m. Total charging refrigerant is 140kg or less. 4) Indoor above condition: If the height difference between indoor units exceeds 3 m, set 30 m or less. Indoor below condition: If the height difference between indoor units exceeds 3 m, set 50 m or less. Also Extension up till 90m is possible. Be sure to refer the Engineering Databook for details of these conditions and requirements. 5) The unit operates down to an outdoor temperature of -10°C, however cooling performance may decline considerably when total operating capacity of indoor units is less than 4HP while ambient temperature is below -5°C. Consider installation location/surroundings and system design when expected to operate below -5°C. On single outdoor unit only. No height difference between units. 6) Low ambient cooling (-5 degC or less) is limited to application. 7) The unit operates down to an outdoor temperature of -25°C, however considerable performance decrease will be expected below -20°C. Consider installation location/surroundings and system design when expected to operate between -20°C and -25°C. 8) Low ambient heating (-20degC or less) for extended periods of time is not allowed. 9) This pipe size can be used in less local refrigerant charge condition. Refrigerant saving condition can be adopted under all the conditions below. - Real length of main piping (L1): 50m or less. - Height difference between outdoor and indoor units(H1): 30m or less. - Total capacity codes of all outdoor units is 14 HP to below 46 HP. C = cooling mode. H = heating mode

SMMS-e Capacity table - Standard model

Capacity	Combination	Model	Cooling capacity	Heating capacity	EER	SEER	COP	SCOP	Max indoor connectivity
8 HP	8	MMY-MAP0806T8P-E/TR	22.4	25	4.04	6.24	4.52	3.64	18
10 HP	10	MMY-MAP1006T8P-E/TR	28	31.5	3.64	6.15	4.25	3.54	22
12 HP	12	MMY-MAP1206T8P-E/TR	33.5	37.5	3.35	6.03	3.89	3.67	27
14 HP	14	MMY-MAP1406T8P-E/TR	38.4	45	3.25	5.69	4.02	3.57	31
16 HP	16	MMY-MAP1606T8P-E/TR	45	50	3.15	5.33	3.88	3.7	36
18 HP	18	MMY-MAP1806T8P-E/TR	50.4	56	3.45	6.01	3.97	3.59	40
20 HP	20	MMY-MAP2006T8P-E/TR	56	62	3.24	5.74	3.71	3.6	45
22 HP	22	MMY-MAP2206T8P-E/TR	61.5	63	2.65	5.07	3.74	3.49	49
24 HP	12 + 12	MMY-AP2416HT8P-E/TR	67	75	3.35	6.03	3.88	3.67	52
26 HP	14 + 12	MMY-AP2616HT8P-E/TR	73.5	82.5	3.3	5.85	3.97	3.62	58
28 HP	16 + 12	MMY-AP2816HT8P-E/TR	78.5	87.5	3.23	5.65	3.89	3.69	63
30 HP	16 + 14	MMY-AP3016HT8P-E/TR	85	95	3.19	5.5	3.94	3.6	64
32 HP	16 + 16	MMY-AP3216HT8P-E/TR	90	100	3.15	5.33	3.88	3.7	64
34 HP	18 + 16	MMY-AP3416HT8P-E/TR	95.4	106	3.3	5.69	3.93	3.64	64
36 HP	20 + 16	MMY-AP3616HT8P-E/TR	101	113	3.2	5.56	3.78	3.64	64
38 HP	22 + 16	MMY-AP3816HT8P-E/TR	106.5	114	2.84	5.2	3.8	3.59	64
40 HP	20 + 20	MMY-AP4016HT8P-E/TR	112	126	3.24	5.74	3.71	3.6	64
42 HP	22 + 20	MMY-AP4216HT8P-E/TR	117.5	127	2.9	5.4	3.72	3.55	64
44 HP	22 + 22	MMY-AP4416HT8P-E/TR	123	128	2.65	5.07	3.74	3.49	64
46 HP	16 + 16 + 14	MMY-AP4616HT8P-E/TR	130	145	3.18	5.44	3.92	3.67	64
48 HP	16 + 16 + 16	MMY-AP4816HT8P-E/TR	135	150	3.15	5.33	3.88	3.7	64
50 HP	18 + 16 + 16	MMY-AP5016HT8P-E/TR	140.4	156	3.25	5.58	3.91	3.66	64
52 HP	20 + 16 + 16	MMY-AP5216HT8P-E/TR	146	163	3.18	5.49	3.81	3.66	64
54 HP	22 + 16 + 16	MMY-AP5416HT8P-E/TR	151.5	164	2.92	5.24	3.82	3.62	64
56 HP	20 + 20 + 16	MMY-AP5616HT8P-E/TR	157	176	3.21	5.62	3.75	3.62	64
58 HP	22 + 20 + 16	MMY-AP5816HT8P-E/TR	162.5	177	2.97	5.38	3.77	3.59	64
60 HP	22 + 22 + 16	MMY-AP6016HT8P-E/TR	168	178	2.77	5.16	3.78	3.55	64

SMMS-e Capacity table - High efficiency & high capacity model

Capacity	Combination	Model	Cooling capacity	Heating capacity	EER	SEER	COP	SCOP	Max indoor connectivity
20 HP	10 + 10	MMY-AP2026HT8P-E/TR	56	63	3.63	6.15	4.26	3.54	45
22 HP	12 + 10	MMY-AP2226HT8P-E/TR	61.5	69	3.47	6.11	4.04	3.61	49
36 HP	12 + 12 + 12	MMY-AP3626HT8P-E/TR	100.5	112.5	3.35	6.03	3.89	3.67	64
38 HP	14 + 12 + 12	MMY-AP3826HT8P-E/TR	107	120	3.31	5.91	3.93	3.63	64
40 HP	14 + 14 + 12	MMY-AP4026HT8P-E/TR	113.5	127.5	3.28	5.8	3.98	3.6	64
42 HP	14 + 14 + 14	MMY-AP4226HT8P-E/TR	120	135	3.25	5.69	4.01	3.57	64
44 HP	16 + 14 + 14	MMY-AP4426HT8P-E/TR	125	140	3.21	5.56	3.97	3.62	64
54 HP	20 + 20 + 14	MMY-AP5426HT8P-E/TR	152	171	3.24	5.74	3.78	3.59	64

MMY-MAP_FT8P
SHRM-e



The SHRM-e, full Inverter heat recovery 3-pipe VRF, is the ultimate simultaneous heating & cooling solution for business applications.

Excellence

- Toshiba’s in-house designed DC twin rotary compressor with outstanding capacity under partial load driven to improve efficiency and comfort.
- Incorporating Toshiba’s latest inverter control, enables the precise modulation of the compressor, ensuring maximum performance and energy savings.
- 2 heat exchangers: outstanding 4-side heat exchanger + sub cooling heat exchanger to optimized efficiency.
- Precise refrigerant control ensures each indoor unit receives the right amount of refrigerant.

Expansion

- A complete range of indoor unit styles and capacity ranges, meets the demands of the customer and the room configuration.
- 7 outdoor unit model line-up from 8 to 20HP that can be installed in a variety of combinations, of up to a capacity of 54HP.

Enhancement

- With up to 1km of total pipe work, an equivalent piping length of 200m, and a maximum height separation of up to 70m, results in a system that is fully adaptable for all types of projects.
- Revolutionary hands-free Wave Tool technology that allows contactless commissioning and diagnoses to be carried out using a smartphone application.

SCOP MAX



3.71

CAPACITY



8HP > 54HP

OPERATION



-25°C > +46°C

The Dual Set Point increases the system’s energy efficiency and reduces overall running costs, with longer periods of time in thermal off mode. Heating and cooling temperatures at which the indoor unit will begin to operate can now be individually selected giving maximum flexibility to the user.

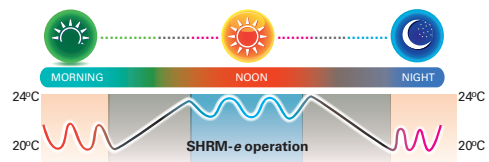

SHRM-e Performances

Outdoor unit	HP	MMY-	MAP0806FT8P-E/TR	MAP1006FT8P-E/TR	MAP1206FT8P-E/TR	MAP1406FT8P-E/TR	MAP1606FT8P-E/TR	MAP1806FT8P-E/TR	MAP2006FT8P-E/TR
			8 HP	10 HP	12 HP	14 HP	16 HP	18 HP	20 HP
Cooling capacity ¹	kW		22.4	28.0	33.5	40.0	45.0	50.4	56.0
Power input	kW	C	5.95	7.96	9.75	12.70	13.90	16.00	18.60
EER	W/W		3.76	3.51	3.43	3.14	3.23	3.15	3.01
EthasC/SEER	W/W		239.8% / 6.07	238.2% / 6.03	234.6% / 5.94	221.4% / 5.61	225.8% / 5.72	232.6% / 5.89	222.6% / 5.64
Running current	A	C	9.44	12.49	15.46	19.92	21.81	25.10	29.18
Heating capacity ²	kW		22.4	28.0	33.5	40.0	45.0	50.4	56.0
Power input	kW	H	5.40	7.05	8.70	10.50	12.20	13.70	15.90
COP	W/W		4.14	3.97	3.85	3.80	3.68	3.67	3.52
EthasH/SCOP			142.6% / 3.64	138.2% / 3.53	145.4% / 3.71	139.8% / 3.57	137% / 3.5	140.6% / 3.59	140.6% / 3.59
Running current	A	H	8.57	11.06	13.80	16.47	19.14	21.49	24.68
Maximum overcurrent protection ³	A		25.0	32.0	40.0	50.0	50.0	50.0	63.0

SHRM-e

SHRM-e Physical data

Outdoor unit	HP	MMY-	MAP0806FT8P-E/TR	MAP1006FT8P-E/TR	MAP1206FT8P-E/TR	MAP1406FT8P-E/TR	MAP1606FT8P-E/TR	MAP1806FT8P-E/TR	MAP2006FT8P-E/TR
Air flow	m³/h		9 700	9 700	12 200	12 200	17 300	17 300	17 900
Air flow	l/s		2 694	2 694	3 389	3 389	4 806	4 806	4 972
Sound Power Level	dB(A)	H	82.0	82.0	82.0	83.0	84	84	84
Sound pressure level	dB(A)	H	61.0	61.0	62.0	64.0	62	62	62
Sound Power Level	dB(A)	C	80.0	80.0	80.0	81.0	83	83	83
Sound pressure level	dB(A)	C	59.0	59.0	60.0	62.0	61	61	61
External Static pressure available	Pa		60	50	50	40	40	40	40
Dimensions (h x w x d)	mm		1830x990x780	1830x990x780	1830x1210x780	1830x1210x780	1830x1600x780	1830x1600x780	1830x1600x780
Weight	kg		263	263	316	316	377	377	377
Compressor type			Hermetic Twin Rotary	Hermetic Twin Rotary	Hermetic Twin Rotary	Hermetic Twin Rotary	Hermetic Twin Rotary	Hermetic Twin Rotary	Hermetic Twin Rotary
Refrigerant charge R410A	kg/TCO2eq		11 / 23	11 / 23	11 / 23	11 / 23	11 / 23	11 / 23	11 / 23
Suction line type - diameter			Brazed - 7/8"	Brazed - 7/8"	Brazed - 1-1/8"	Brazed - 1-1/8"	Brazed - 1-1/8"	Brazed - 1-1/8"	Brazed - 1-1/8"
Liquid line type - diameter			Flare - 1/2"	Flare - 1/2"	Flare - 1/2"	Flare - 5/8"	Flare - 3/4"	Flare - 3/4"	Flare - 3/4"
Discharge line connection type - diameter			Flare - 3/4"	Flare - 3/4"	Flare - 3/4"	Flare - 7/8"	Flare - 7/8"	Flare - 7/8"	Flare - 7/8"
Farthest piping equivalent length ⁴	m		200	200	200	200	200	200	200
Farthest piping actual length	m		180	180	180	180	180	180	180
Maximum pipe length ⁵	m		1000	1000	1000	1000	1000	1000	1000
Maximum lift (indoor unit above/below) ⁶	m		30/70	30/70	30/70	30/70	30/70	30/70	30/70
Operating range - db ⁷	°C	C	-10/46	-10/46	-10/46	-10/46	-10/46	-10/46	-10/46
Operating range - wb ⁸	°C	H	-25/15.5	-25/15.5	-25/15.5	-25/15.5	-25/15.5	-25/15.5	-25/15.5
Power supply	V-ph-Hz		380/415-3-50	380/415-3-50	380/415-3-50	380/415-3-50	380/415-3-50	380/415-3-50	380/415-3-50

1) based on an indoor air temperature of 27°C db/19°C wb and an outdoor air temperature of 35°C db. 2) based on an indoor air temperature of 20°C db and an outdoor air temperature of 7°C db/6°C wb. 3) If outdoor units are combined, refer to the installation manual. 4) Allowable values for length equivalent to furthest pipe are shown following and they vary according to performance rank of outdoor unit. (22.4 to 56.0: 180m, 61.5 to 112:195m, 120:200m.). 5) Less than 34HP: 300m. Total charging refrigerant is 140 kg or less. 6) Indoor above condition: 40m is possible for a system that uses only the flow selector unit (single port long piping type and multi port type), whose all the indoor units are 3HP or higher, and working ambient temperature is 0°C or higher. Indoor below condition: If the height difference between indoor units exceed 3 m, set 50 m or less. Also Extension up till 90m is possible. Be sure to refer the Engineering Databook for details of these conditions and requirements. 7) Low ambient cooling (-5degC or less) 1. Not suitable for applications, which require precise room temperature control, due to increased risk of indoor ON/OFF control and potential low air off temperatures. 2. For areas that do demand a precise room temperature control, we would recommend the installation of a secondary system, which has been designed solely for the purpose of low ambient cooling. 8) The unit operates down to an outdoor temperature of -25°C, however considerable performance decrease will be expected below -20°C. Consider installation location/surroundings and system design when expected to operate between -20°C and -25°C.

SHRM-e Capacity table - Standard model

Capacity	Combination	Modèle	Cooling capacity	Heating capacity	EER	SEER	COP	SCOP	Max indoor connectivity
8 HP	8	MMY-MAP0806FT8P-E/TR	22.4	25	3.76	6.19	4.14	3.64	18
10 HP	10	MMY-MAP1006FT8P-E/TR	28	31.5	3.51	6.13	3.97	3.54	22
12 HP	12	MMY-MAP1206FT8P-E/TR	33.5	37.5	3.43	6.02	3.85	3.71	27
14 HP	14	MMY-MAP1406FT8P-E/TR	40	45	3.14	5.67	3.8	3.57	31
16 HP	16	MMY-MAP1606FT8P-E/TR	45	50	3.26	5.78	3.68	3.51	36
18 HP	18	MMY-MAP1806FT8P-E/TR	50.4	56.5	3.15	5.94	3.67	3.59	40
20 HP	20	MMY-MAP2006FT8P-E/TR	56	58	3.01	5.68	6.52	3.6	41
22 HP	12 + 10	MMY-AP2216FT8P-E/TR	61.5	69	3.47	6.07	3.9	3.64	49
24 HP	14 + 10	MMY-AP2416FT8P-E/TR	68	76.5	3.29	5.88	3.8	3.56	51
26 HP	14 + 12	MMY-AP2616FT8P-E/TR	73.5	82.5	3.27	5.84	3.83	3.64	58
28 HP	14 + 14	MMY-AP2816FT8P-E/TR	80	90	3.15	5.67	3.81	3.57	63
30 HP	16 + 14	MMY-AP3016FT8P-E/TR	85	95	3.2	5.72	3.74	3.54	64
32 HP	18 + 14	MMY-AP3216FT8P-E/TR	90.4	101.5	3.15	5.82	3.1	3.59	64
34 HP	18 + 16	MMY-AP3416FT8P-E/TR	95.4	106.5	3.19	5.86	3.68	3.55	64
36 HP	18 + 18	MMY-AP3616FT8P-E/TR	100.8	113	3.15	5.94	3.68	3.59	64
38 HP	20 + 18	MMY-AP3816FT8P-E/TR	106.4	114.5	3.08	5.81	3.59	3.6	64
40 HP	20 + 20	MMY-AP4016FT8P-E/TR	112	116	3.01	5.68	3.52	3.6	64
42 HP	14 + 14 + 14	MMY-AP4216FT8P-E/TR	120	135	3.15	5.67	3.81	3.57	64
44 HP	16 + 14 + 14	MMY-AP4416FT8P-E/TR	125	140	3.18	5.71	3.77	3.55	64
46 HP	18 + 14 + 14	MMY-AP4616FT8P-E/TR	130.4	146.5	3.15	5.78	3.76	3.58	64
48 HP	18 + 16 + 14	MMY-AP4816FT8P-E/TR	135.4	151.5	3.25	5.83	3.7	3.57	64
50 HP	18 + 18 + 14	MMY-AP5016FT8P-E/TR	140.8	158	3.21	5.88	3.7	3.59	64
52 HP	18 + 18 + 16	MMY-AP5216FT8P-E/TR	145.8	163	3.18	5.89	3.68	3.57	64
54 HP	18 + 18 + 18	MMY-AP5416FT8P-E/TR	152.1	169.5	3.15	5.94	3.68	3.59	64

MMY-MAP_FT8P
SHRM-e



The SHRM-e, full Inverter heat recovery 3-pipe VRF, is the ultimate simultaneous heating & cooling solution for business applications.

Excellence

- Toshiba's in-house designed DC twin rotary compressor with outstanding capacity under partial load driven to improve efficiency and comfort.
- Incorporating Toshiba's latest inverter control, enables the precise modulation of the compressor, ensuring maximum performance and energy savings.
- 2 heat exchangers: outstanding 4-side heat exchanger + sub cooling heat exchanger to optimized efficiency.
- Precise refrigerant control ensures each indoor unit receives precisely the right amount of refrigerant.

Expansion

- 7 outdoor unit model line-up from 8 to 20HP that can be installed in a variety of combinations, of up to a capacity of 42HP.
- A complete range of indoor unit styles and capacity ranges, meets the demands of the customer and the room configuration.

Enhancement

- Up to 1km total piping length; 200m in equivalent length and 70m of height difference.
- Revolutionary hands-free Wave Tool technology that allows contactless commissioning and diagnoses to be carried out using a smartphone application.

SCOP MAX



3.71

CAPACITY



8HP > 42HP

OPERATION



-25°C > +46°C

In addition to the existing 3 series and new 4 series single port flow selector, Toshiba is proud to release the all new 4 and 6 port multi box, that enables multiple indoor unit connection, increasing the design flexibility and ease of installation.



SHRM-e Performances

Outdoor unit	HP	MMY-	MAP0806FT8P-UK	MAP1006FT8P-UK	MAP1206FT8P-UK	MAP1406FT8P-UK	MAP1606FT8P-UK	MAP1806FT8P-UK	MAP2006FT8P-UK
			8 HP	10 HP	12 HP	14 HP	16 HP	18 HP	20 HP
Cooling capacity ¹	kW		22.4	28.0	33.5	40.0	45.0	50.4	56.0
Power input	kW	C	5.95	7.96	9.75	12.70	13.90	16.00	18.60
EER	W/W		3.76	3.51	3.43	3.14	3.23	3.15	3.01
EthasC/SEER	W/W		239.8% / 6.07	238.2% / 6.03	234.6% / 5.94	221.4% / 5.61	225.8% / 5.72	232.6% / 5.89	222.6% / 5.64
Running current	A	C	9.44	12.49	15.46	19.92	21.81	25.10	29.18
Heating capacity ²	kW		22.4	28.0	33.5	40.0	45.0	50.4	56.0
Power input	kW	H	5.40	7.05	8.70	10.50	12.20	13.70	15.90
COP	W/W		4.14	3.97	3.85	3.80	3.68	3.67	3.52
EthasH/SCOP			142.6% / 3.64	138.2% / 3.53	145.4% / 3.71	139.8% / 3.57	137% / 3.5	140.6% / 3.59	140.6% / 3.59
Running current	A	H	8.57	11.06	13.80	16.47	19.14	21.49	24.68
Maximum overcurrent protection ³	A		25.0	32.0	40.0	50.0	50.0	50.0	63.0

SHRM-e Physical data

Outdoor unit	HP	MMY- MAP0806FT8P-UK	MAP1006FT8P-UK	MAP1206FT8P-UK	MAP1406FT8P-UK	MAP1606FT8P-UK	MAP1806FT8P-UK	MAP2006FT8P-UK
Air flow	m ³ /h	9 700	9 700	12 200	12 200	17 300	17 300	17 900
Air flow	l/s	2 694	2 694	3 389	3 389	4 806	4 806	4 972
Sound Power Level	dB(A)	H	82.0	82.0	82.0	83.0	84	84
Sound pressure level	dB(A)	H	61.0	61.0	62.0	64.0	62	62
Sound Power Level	dB(A)	C	80.0	80.0	80.0	81.0	83	83
Sound pressure level	dB(A)	C	59.0	59.0	60.0	62.0	61	61
External Static pressure available	Pa	60	50	50	40	40	40	40
Dimensions (h x w x d)	mm	1830 x 990 x 780	1830 x 990 x 780	1830 x 1210 x 780	1830 x 1210 x 780	1830 x 1600 x 780	1830 x 1600 x 780	1830 x 1600 x 780
Weight	kg	263	263	316	316	377	377	377
Compressor type		Hermetic Twin Rotary	Hermetic Twin Rotary	Hermetic Twin Rotary	Hermetic Twin Rotary	Hermetic Twin Rotary	Hermetic Twin Rotary	Hermetic Twin Rotary
Refrigerant charge R410A	kg/TCO2eq	11 / 23	11 / 23	11 / 23	11 / 23	11 / 23	11 / 23	11 / 23
Suction line type - diameter		Brazed - 7/8"	Brazed - 7/8"	Brazed - 1-1/8"	Brazed - 1-1/8"	Brazed - 1-1/8"	Brazed - 1-1/8"	Brazed - 1-1/8"
Liquid line type - diameter		Flare - 1/2"	Flare - 1/2"	Flare - 1/2"	Flare - 5/8"	Flare - 3/4"	Flare - 3/4"	Flare - 3/4"
Discharge line connection type - diameter		Flare - 3/4"	Flare - 3/4"	Flare - 3/4"	Flare - 7/8"	Flare - 7/8"	Flare - 7/8"	Flare - 7/8"
Farthest piping equivalent length ⁴	m	200	200	200	200	200	200	200
Farthest piping actual length	m	180	180	180	180	180	180	180
Maximum pipe length ⁵	m	1000	1000	1000	1000	1000	1000	1000
Maximum lift (Indoor unit above/below) ⁶	m	30/70	30/70	30/70	30/70	30/70	30/70	30/70
Operating range - db ⁷	°C	C	-10 / 46	-10 / 46	-10 / 46	-10 / 46	-10 / 46	-10 / 46
Operating range - wb ⁸	°C	H	-25 / 15.5	-25 / 15.5	-25 / 15.5	-25 / 15.5	-25 / 15.5	-25 / 15.5
Power supply	V-ph-Hz	380 / 415-3-50	380 / 415-3-50	380 / 415-3-50	380 / 415-3-50	380 / 415-3-50	380 / 415-3-50	380 / 415-3-50

1) based on an indoor air temperature of 27°C db/19°C wb and an outdoor air temperature of 35°C db. 2) based on an indoor air temperature of 20°C db and an outdoor air temperature of 7°C db/6°C wb. 3) If outdoor units are combined, refer to the installation manual. 4) Allowable values for length equivalent to furthest pipe are shown following and they vary according to performance rank of outdoor unit. (22.4 to 56.0: 180m, 61.5 to 112:195m, 120:200m.). 5) Less than 34HP: 300m. Total charging refrigerant is 140 kg or less. 6) Indoor above condition: 40m is possible for a system that uses only the flow selector unit (single port long piping type and multi port type), whose all the indoor units are 3HP or higher, and working ambient temperature is 0°C or higher. Indoor below condition: If the height difference between indoor units exceed 3 m, set 50 m or less. Also Extension up till 90m is possible. Be sure to refer the Engineering Databook for details of these conditions and requirements. 7) Low ambient cooling (-5degC or less). 1. Not suitable for applications, which require precise room temperature control, due to increased risk of indoor ON/OFF control and potential low air off temperatures. 2. For areas that do demand a precise room temperature control, we would recommend the installation of a secondary system, which has been designed solely for the purpose of low ambient cooling. 8) The unit operates down to an outdoor temperature of -25°C, however considerable performance decrease will be expected below -20°C. Consider installation location/surroundings and system design when expected to operate between -20°C and -25°C.

SHRM-e Capacity table - Standard model

Capacity	Combination	Modèle	Cooling capacity	Heating capacity	EER	SEER	COP	SCOP	Max indoor connectivity
8 HP	8	MMY-MAP0806FT8P-UK	22.4	25	3.76	6.19	4.14	3.64	18
10 HP	10	MMY-MAP1006FT8P-UK	28	31.5	3.51	6.13	3.97	3.54	22
12 HP	12	MMY-MAP1206FT8P-UK	33.5	37.5	3.43	6.02	3.85	3.71	27
14 HP	14	MMY-MAP1406FT8P-UK	40	45	3.14	5.67	3.8	3.57	31
16 HP	16	MMY-MAP1606FT8P-UK	45	50	3.26	5.78	3.68	3.51	36
18 HP	18	MMY-MAP1806FT8P-UK	50.4	56.5	3.15	5.94	3.67	3.59	40
20 HP	20	MMY-MAP2006FT8P-UK	56	58	3.01	5.68	6.52	3.6	41
22 HP	12 + 10	MMY-AP2216FT8P-UK	61.5	69	3.47	6.07	3.9	3.64	49
24 HP	14 + 10	MMY-AP2416FT8P-UK	68	76.5	3.29	5.88	3.8	3.56	51
26 HP	14 + 12	MMY-AP2616FT8P-UK	73.5	82.5	3.27	5.84	3.83	3.64	58
28 HP	14 + 14	MMY-AP2816FT8P-UK	80	90	3.15	5.67	3.81	3.57	63
30 HP	16 + 14	MMY-AP3016FT8P-UK	85	95	3.2	5.72	3.74	3.54	64
32 HP	18 + 14	MMY-AP3216FT8P-UK	90.4	101.5	3.15	5.82	3.1	3.59	64
34 HP	18 + 16	MMY-AP3416FT8P-UK	95.4	106.5	3.19	5.86	3.68	3.55	64
36 HP	18 + 18	MMY-AP3616FT8P-UK	100.8	113	3.15	5.94	3.68	3.59	64
38 HP	20 + 18	MMY-AP3816FT8P-UK	106.4	114.5	3.08	5.81	3.59	3.6	64
40 HP	20 + 20	MMY-AP4016FT8P-UK	112	116	3.01	5.68	3.52	3.6	64
42 HP	14 + 14 + 14	MMY-AP4216FT8P-UK	120	135	3.15	5.67	3.81	3.57	64
34 HP	18 + 16	MMY-AP3416FT8P-UK	95.4	106.5	7.95	3.19	3.68	5.14	64
36 HP	18 + 18	MMY-AP3616FT8P-UK	100.8	113	7.86	3.15	3.68	5.4	64
38 HP	20 + 18	MMY-AP3816FT8P-UK	106.4	114.5	7.35	3.08	3.59	4.88	64
40 HP	20 + 20	MMY-AP4016FT8P-UK	112	116	7.1	3.01	3.52	4.78	64
42 HP	14 + 14 + 14	MMY-AP4216FT8P-UK	120	135	7.3	3.15	3.81	5.61	64

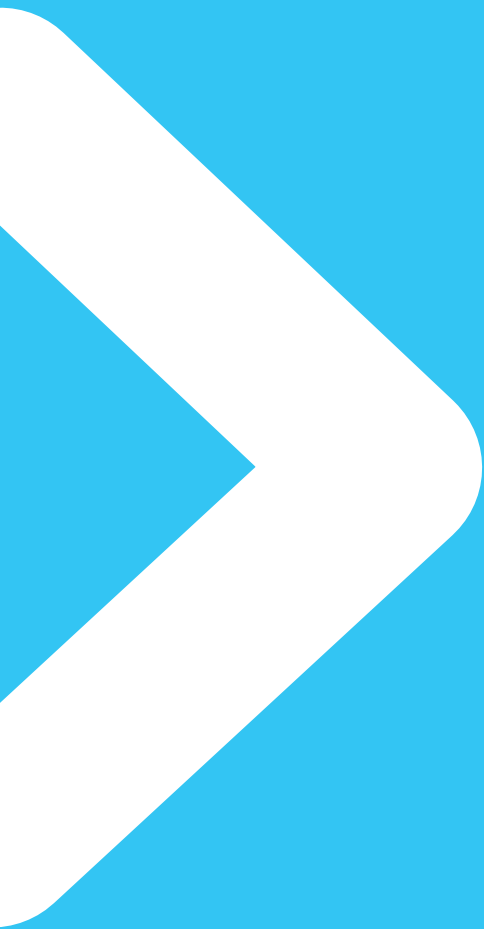

EUROPE

**CE Mark
indoor units**

CHOOSE YOUR ADAPTED SYSTEM SOLUTION

INDOOR UNITS, HOT WATER & FRESH AIR SOLUTIONS

		Basic specifications																	
Model type	Class	003	005	007	009	012	015	018	024	027	030	036	048	056	072	096	112	128	
	Cooling/Heating capacity in kW	0.9 /1.1	1.7 /1.9	2.2 /2.5	2.8 /3.2	3.6 /4	4.5 /5	5.6 /6.3	7.1 /8	8.0 /9	9.0 /10	11.2 /12.5	14.0 /16	16.0 /18	22.4 /25	28.0 /31.5	33.5 /20.8	40 /25.2	
	Cooling/Heating capacity in HP	0.3*	0.6	0.8	1	1.25	1.7	2	2.5	3	3.2	4	5	6	8	10	12	14	
FOR EUROPE	Compact 4-way discharge cassette	MMU-UP***1MH-E		●	●	●	●	●											
	Smart 4-way discharge cassette**	MMU-UP***H-E				●	●	●	●	●	●	●	●	●					
	4-way discharge cassette	MMU-UP***1HP-E				●	●	●	●	●	●	●	●	●					
	2-way discharge cassette	MMU-UP***1WH-E			●	●	●	●	●	●	●	●	●	●					
	1-way discharge cassette	MMU-UP**1YP/1SH-E	●	●	●	●	●	●	●										
	Slim duct	MMD-UP***1SPHY-E	●	●	●	●	●	●	●	●									
	Concealed duct	MMD-UP***1BHP-E		●	●	●	●	●	●	●	●	●	●	●					
	Concealed duct high static	MMD-UP***1HP-E							●	●	●		●	●	●	●	●		
	Ceiling suspended	MMC-UP***1HP-E						●	●	●	●		●	●	●				
	Floor-standing concealed	MML-UP***1BH-E			●	●	●	●	●	●									
	Floor-standing cabinet	MML-UP***1H-E			●	●	●	●	●	●									
	Bi-flow console	MML-UP***1NH-E			●	●	●	●	●										
	Floor standing	MMF-UP***1H-E						●	●	●	●		●	●	●				
	High wall (With & without PMV)	MMK-UP***1HP-E MMK-UP***1HPL-E	●	●	●	●	●	●	●	●	●	●							
	Mid temperature Hot Water module	MMW-UP**1LQ-E									●			●					
	High temperature Hot Water module	MMW-AP**1CHQ-E											●						
	EMEA AHU DX Kit (std version)	MM-DXC010 + MM-DXV***							●	●	●		●	●		●	●		
	EMEA AHU DX Kit (0/10v version)	RBC-DXC031 + MM-DXV***												●	●	●	●		
	Fresh air intake indoor unit	MMD-UP***1HP-E											●		●	●	●	●	●

AIR TO AIR HEAT EXCHANGER

		Basic specifications									
Model type	Air flow in m³/h	150	250	350	500	650	800	1000	1500	2000	
	Cooling/Heating capacity in kW for models with DX coil				4.5/5		6.5/8.6	8.2/10.9			
Air-to-air heat exchanger	VN-M**0HE	●	●	●	●	●	●	●	●	●	
A2A heat exchanger + DXcoil or + Dxcoil & Humidifier	MMD-VN***2HEXE MMD-VNK***2HEXE				●		●	●			

●:Heat pump
* Only compatible with SMMS-u
** Available mid 2021

MMU-UP_MH
COMPACT 4-WAY CASSETTE



The compact 4-way cassette has been especially designed for business office applications, where a compact and efficient solution is required.

Design

- Smart flat-panel design with clean lines that will complement any decorative style.
- Fit within the T-bar of grid ceiling: 620mm X 620mm.

Comfort

- A user programmable 5-step flow with individual louvre swing control, plus a new "cycle-swing" harmonised louvre setting
- The occupancy motion sensor can be configured to switch the unit into standby mode or completely switched off, when no movement is detected, minimising the energy usage of the system.

Easy to install

- Only 256mm height, this compact chassis is perfectly suited to confined spaces.
- Built-in high-lift drain pump.
- Lightweight unit, for easy and quick installation.

CAPACITY



1.7kW > 6.3kW

SOUND PRESSURE LEVEL



29dB(A)

OUTDOOR UNITS



Side Blow & MINI SMMS-e



SMMS-u



SMMS-e & SHRM-e

LOCAL CONTROLS



RBC-AXU31UM-E
RBC-AXU31-E



RBC-AMSU51E-ES(EN)
RBC-AMTU31-E
RBC-ASCU11-E

COMPACT 4-WAY CASSETTE Performances

Indoor unit	MMU-	UP0051MH-E/TR	UP0071MH-E/TR	UP0091MH-E/TR	UP0121MH-E/TR	UP0151MH-E/TR	UP0181MH-E/TR
Cooling capacity	kW	1,7	2,2	2,8	3,6	4,5	5,6
Heating capacity	kW	1,9	2,5	3,2	4,0	5,0	6,3
Power consumption	kW	0.016	0.023	0.025	0.027	0.030	0.052
Running current	A	0.16	0.23	0.24	0.25	0.28	0.46
Starting current	A	0.28	0.41	0.43	0.44	0.50	0.80

COMPACT 4-WAY CASSETTE Physical data

Indoor unit	MMU-	UP0051MH-E/TR	UP0071MH-E/TR	UP0091MH-E/TR	UP0121MH-E/TR	UP0151MH-E/TR	UP0181MH-E/TR
Air Flow (h/m+/m/l+/l)	m³/h	430/415/400/385/365	552/500/462/395/378	570/520/468/395/378	594/550/504/420/402	660/600/552/480/468	840/740/642/540/522
Air Flow (h/m+/m/l+/l)	l/s	119/115/111/107/101	153/139/128/110/105	158/144/130/110/105	165/153/140/117/112	183/167/153/133/130	233/206/178/150/145
Sound pressure level (h/m+/m/l+/l)	dB(A)	32/31/30/29/29	37/34/33/30/29	38/35/33/30/29	38/36/34/31/30	40/37/35/32/31	47/43/39/36/34
Sound power level (h/m+/m/l+/l)	dB(A)	47/46/45/44/44	52/49/48/45/44	53/50/48/45/44	53/51/49/46/45	55/52/50/47/46	62/58/54/51/49
Dimensions (HxWxD)	mm	256x575x575	256x575x575	256x575x575	256x575x575	256x575x575	256x575x575
Weight	kg	15	15	15	15	15	15
Panel		RBC-UM21PG(W)-E					
Panel dimensions (HxWxD)	mm	12x620x620	12x620x620	12x620x620	12x620x620	12x620x620	12x620x620
Panel weight	kg	2.5	2.5	2.5	2.5	2.5	2.5
Connecting pipe, gas	in	3/8"	3/8"	3/8"	3/8"	1/2"	1/2"
Connecting pipe, liquid	in	1/4"	1/4"	1/4"	1/4"	1/4"	1/4"
Drain port diameter	mm	20	20	20	20	20	20
Power supply	V-ph-Hz	220/240-1-50	220/240-1-50	220/240-1-50	220/240-1-50	220/240-1-50	220/240-1-50

MMU-UP_HP 4-WAY CASSETTE

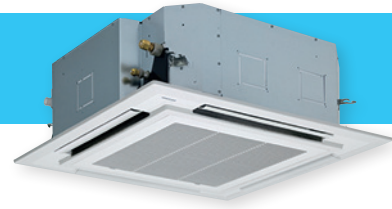

The 4-way cassette is designed to provide uniform air distribution and total user comfort making this unit the ideal solution for small commercial applications.

Comfort

- Two louver shape option: straight flow louver and wide flow louver for optimum air distribution.
- Possibility to set three different swing modes providing individual control to maximise end user comfort.
- Wide air flow in all directions.
- Optimal air diffusion up to 4.6m ceiling height!

Reliability

- Self-cleaning function and Ag-ion tip for anti-mould in drain cap.
- Built-in high-lift drain pump.

Easy to install

- Compact chassis with only 256mm height (up to size 30).
- Lightweight unit, for easy and quick installation.

CAPACITY



2.8kW > 18kW

SOUND PRESSURE LEVEL



27dB(A)

OUTDOOR UNITS



Side Blow
& Mini SMMS-e



SMMS-u



SMMS-e
& SHRM-e

LOCAL CONTROLS



RBC-AXU31U-E
RBC-AXU31-E



RBC-AMSU51E-ES(EN)
RBC-AMTU31-E
RBC-ASCU11-E

4-WAY CASSETTE Performances

Indoor unit	MMU-	UP0091HP-E/TR	UP0121HP-E/TR	UP0151HP-E/TR	UP0181HP-E/TR	UP0241HP-E/TR	UP0271HP-E/TR	UP0301HP-E/TR	UP0361HP-E/TR	UP0481HP-E/TR	UP0561HP-E/TR
Cooling capacity	kW	2,8	3,6	4,5	5,6	7,1	8,0	9,0	11,2	14,0	16,0
Heating capacity	kW	3,2	4,0	5,0	6,3	8,0	9,0	10,0	12,5	16,0	18,0
Power consumption	kW	0,021	0,021	0,023	0,026	0,036	0,036	0,043	0,088	0,112	0,112
Running current	A	0,23	0,23	0,27	0,29	0,38	0,38	0,43	0,78	0,88	0,88
Starting current	A	0,30	0,30	0,33	0,36	0,42	0,42	0,59	0,87	1,23	1,26

4-WAY CASSETTE Physical data

Indoor unit	MMU-	UP0091HP-E/TR	UP0121HP-E/TR	UP0151HP-E/TR	UP0181HP-E/TR	UP0241HP-E/TR	UP0271HP-E/TR	UP0301HP-E/TR	UP0361HP-E/TR	UP0481HP-E/TR	UP0561HP-E/TR
Air Flow (h/m/l)	m ³ /h	800/730/680	800/730/680	930/830/790	1050/920/800	1290/920/800	1290/920/800	1320/1100/850	1970/1430/1070	2130/1430/1130	2130/1520/1230
Air Flow (h/m/l)	l/s	222/203/189	222/203/189	258/231/219	292/256/222	358/256/222	358/256/222	367/306/236	547/397/297	592/397/314	592/422/342
Sound pressure level (h/m/l)	dB(A)	30/29/27	30/29/27	31/29/27	32/29/27	35/31/28	35/31/28	38/33/30	43/38/32	46/38/33	46/40/33
Sound power level (h)	dB(A)	45	45	46	47	50	50	53	58	61	61
Dimensions (HxWxD)	mm	256x840x840	256x840x840	256x840x840	256x840x840	256x840x840	256x840x840	256x840x840	319x840x840	319x840x840	319x840x840
Weight	kg	18	18	20	20	20	20	20	25	25	25
Panel		RBC-U32PGP-E									
Panel dimensions (HxWxD)	mm	30x950x950	30x950x950	30x950x950	30x950x950	30x950x950	30x950x950	30x950x950	30x950x950	30x950x950	30x950x950
Panel weight	kg	4	4	4	4	4	4	4	4	4	4
Connecting pipe, gas		3/8"	3/8"	1/2"	1/2"	5/8"	5/8"	5/8"	5/8"	5/8"	5/8"
Connecting pipe, liquid		1/4"	1/4"	1/4"	1/4"	3/8"	3/8"	3/8"	3/8"	3/8"	3/8"
Drain port diameter	mm	25	25	25	25	25	25	25	25	25	25
Power supply	V-ph-Hz	220/240-1-50	220/240-1-50	220/240-1-50	220/240-1-50	220/240-1-50	220/240-1-50	220/240-1-50	220/240-1-50	220/240-1-50	220/240-1-50

MMU-UP_WH
2-WAY CASSETTE

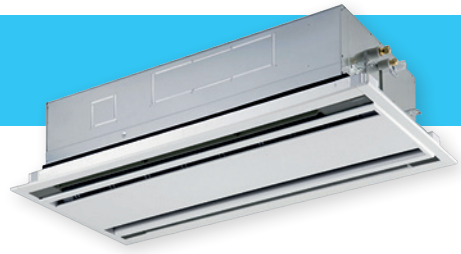

Slim, compact and lightweight, the 2-way cassette has been designed to fit easily and discretely into any room interior.

Comfort

- Unique air flow control, provides a balanced flow of air in two opposite directions, maximising air flow distribution. This feature when combined with the units fresh air intake ability helps to provide a perfect solution all year round.
- Enhanced indoor air quality with standard long-life filters with a wide bended surface to effectively collect dust particles.

Design

- The elegant white decoration panel allows the unit to be installed seamlessly into any room.

Easy to install

- Minimal weight (19kg) for units up to 4.5kw.
- Compact dimensions (height 295mm).
- Built-in drain pump.

CAPACITY



2.2kW > 18kW

SOUND PRESSURE LEVEL



30dB(A)

OUTDOOR UNITS



Side Blow & MiNi SMMS-e



SMMS-u



SMMS-e & SHRM-e

LOCAL CONTROLS



TCB-AXU31-E



RBC-AMSU51E-ES(EN)
RBC-AMTU31-E
RBC-ASCU11-E

2-WAY CASSETTE Performances

Indoor unit	MMU-	UP0071WH-E/TR	UP0091WH-E/TR	UP0121WH-E/TR	UP0151WH-E/TR	UP0181WH-E/TR	UP0241WH-E/TR	UP0271WH-E/TR	UP0301WH-E/TR	UP0361WH-E/TR	UP0481WH-E/TR	UP0561WH-E/TR
Cooling capacity	kW	2,2	2,8	3,6	4,5	5,6	7,1	8,0	9,0	11,2	14,0	16,0
Heating capacity	kW	2,5	3,2	4,0	5,0	6,3	8,0	9,0	10,0	12,5	16,0	18,0
Power consumption	kW	0,029	0,029	0,029	0,030	0,044	0,054	0,054	0,064	0,073	0,088	0,117
Running current	A	0,23	0,23	0,23	0,24	0,32	0,39	0,39	0,46	0,48	0,57	0,75
Starting current	A	0,35	0,35	0,35	0,36	0,48	0,59	0,59	0,69	0,72	0,86	1,13

2-WAY CASSETTE Physical data

Indoor unit	MMU-	UP0071WH-E/TR	UP0091WH-E/TR	UP0121WH-E/TR	UP0151WH-E/TR	UP0181WH-E/TR	UP0241WH-E/TR	UP0271WH-E/TR	UP0301WH-E/TR	UP0361WH-E/TR	UP0481WH-E/TR	UP0561WH-E/TR	
Air Flow (h/m/l)	m³/h	558/498/450	558/498/450	558/498/450	600/534/450	900/750/618	1050/840/738	1050/840/738	1260/900/780	1740/1434/1182	1800/1482/1230	2040/1578/1320	
Air Flow (h/m/l)	l/s	155/138/125	155/138/125	155/138/125	167/148/125	250/208/172	291/233/205	291/233/205	350/250/217	483/398/328	500/412/342	567/438/367	
Sound pressure level (h/m/l)	dB(A)	34/32/30	34/32/30	34/32/30	35/33/30	35/33/30	38/35/33	38/35/33	40/37/34	42/39/36	43/40/37	46/42/39	
Sound power level (h)	dB(A)	49	49	49	50	50	53	53	55	57	58	61	
Dimensions (HxWxD)	mm	295x815x570	295x815x570	295x815x570	295x815x570	345x1180x570	345x1180x570	345x1180x570	345x1180x570	345x1600x570	345x1600x570	345x1600x570	
Weight	kg	19	19	19	19	26	26	26	26	36	36	36	
Panel		RBC-UW283PG(W)-E						RBC-UW803PG(W)-E			RBC-UW1403PG(W)-E		
Panel dimensions (HxWxD)	mm	20x1050x680	20x1050x680	20x1050x680	20x1050x680	20x1415x680	20x1415x680	20x1415x680	20x1415x680	20x1835x680	20x1835x680	20x1835x680	
Panel weight	kg	10	10	10	10	14	14	14	14	14	14	14	
Connecting pipe, gas		3/8"	3/8"	3/8"	1/2"	1/2"	5/8"	5/8"	5/8"	5/8"	5/8"	5/8"	
Connecting pipe, liquid		1/4"	1/4"	1/4"	1/4"	1/4"	3/8"	3/8"	3/8"	3/8"	3/8"	3/8"	
Drain port diameter	mm	25	25	25	25	25	25	25	25	25	25	25	
Power supply	V-ph-Hz	220/240-1-50	220/240-1-50	220/240-1-50	220/240-1-50	220/240-1-50	220/240-1-50	220/240-1-50	220/240-1-50	220/240-1-50	220/240-1-50	220/240-1-50	

MMU-UP_YHP/SH
1-WAY CASSETTE

> NEW



Toshiba's innovative slim-line 1-way cassette is simple to install and suitable for small areas, such as hotels, offices and reception rooms.

Design

- New white elegant panel design to match all types of interiors.

Flexibility

- 150mm chassis height adapted to low suspended ceilings conditions.
- Capacity from 0.3HP for high efficiency buildings.

Comfort

- Low noise level down to 25 dB(A) for quiet operation.
- 5-speed fan operation for perfect air flow (YHP only) management.
- Air purifier available as an option to keep a fresh and clean environment (YHP only).

Comfort

- Low noise level down to 25 dB(A) for quiet operation.
- 5-speed fan operation for perfect air flow (YHP only).

CAPACITY



0.9kW > 8kW

SOUND PRESSURE LEVEL



25dB(A)

OUTDOOR UNITS



Side Blow & Mini SMMS-e



SMMS-u



SMMS-e & SHRM-e

LOCAL CONTROLS



RBC-AX33UYP-E (YHP)
RBC-AXU31C-E (SH)



RBC-AMSU51E-ES/EN
RBC-AMTU31-E
RBC-ASCU11-E

1-WAY CASSETTE Performances

Indoor unit	MMU-	UP0031YHP-E/TR	UP0051YHP-E/TR	UP0071YHP-E/TR	UP0091YHP-E/TR	UP0121YHP-E/TR	UP0151SH-E/TR	UP0181SH-E/TR	UP0241SH-E/TR
Cooling capacity	kW	0,9	1,7	2,2	2,8	3,6	4,5	5,6	7,1
Heating capacity	kW	1,3	1,9	2,5	3,2	4,0	5,0	6,3	8,0
Power consumption	kW	0,015	0,015	0,017	0,018	0,018	0,042	0,046	0,075
Running current	A	0,15	0,15	0,18	0,19	0,20	0,34	0,37	0,62
Starting current	A	-	-	-	-	-	0,51	0,54	0,80

1-WAY CASSETTE Physical data

Indoor unit	MMU-	UP0031YHP-E/TR	UP0051YHP-E/TR	UP0071YHP-E/TR	UP0091YHP-E/TR	UP0121YHP-E/TR	UP0151SH-E/TR	UP0181SH-E/TR	UP0241SH-E/TR	
Air Flow (h/l)	m ³ /h	480/370/270	480/370/270	500/390/270	520/410/290	540/420/290	750/690/630	780/720/660	1140/960/810	
Air Flow (h/l)	l/s	133/103/75	133/103/75	150/133/117	150/133/117	150/133/117	208/192/175	217/200/183	317/267/225	
Sound pressure level (h/m/l)	dB(A)	37/33/25	37/33/25	38/34/25	39/35/26	40/36/26	37/35/32	38/36/34	45/41/37	
Dimensions (HxWxD)	mm	150x990x450	150x990x450	150x990x450	150x990x450	150x990x450	200x1000x710	200x1000x710	200x1000x710	
Weight	kg	14	14	14	14	14	21	21	22	
Panel		RBC-UY32P-E					RBC-US21PGE			
Panel dimensions (HxWxD)	mm	30x1220x530	30x1220x530	30x1220x530	30x1220x530	30x1220x530	20x1230x800	20x1230x800	20x1230x800	
Panel weight	kg	4	4	4	4	4	5,5	5,5	5,5	
Connecting pipe, gas	in	3/8"	3/8"	3/8"	3/8"	3/8"	1/2"	1/2"	5/8"	
Connecting pipe, liquid	in	1/4"	1/4"	1/4"	1/4"	1/4"	1/4"	1/4"	3/8"	
Drain port diameter	mm	25	25	25	25	25	25	25	25	
Power supply	V-ph-Hz	220/240-1-50	220/240-1-50	220/240-1-50	220/240-1-50	220/240-1-50	220/240-1-50	220/240-1-50	220/240-1-50	

MMD-UP_BHP
STANDARD DUCT

> NEW SIZE 0.6HP

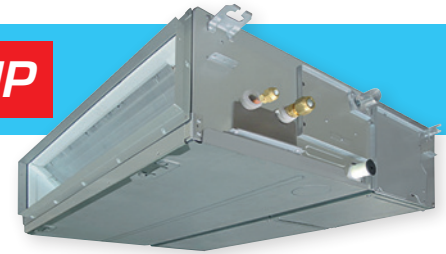

Whatever the shape of the room, this flexible model ensures a uniform temperature and air distribution for optimal end user comfort.

Hidden

- Slimline design, with a depth of just 275mm helps to simplify the installation, even when space is limited.
- Superior low noise operation. Noise output at low fan equates to just 23 dB(A).

Customizable

- External static pressure can be raised up to 150 Pa for extensive ducting.
- Possible to connect a fresh air inlet duct to the unit, to maximise air quality and room air quality.
- Flexible design, allows the inlet air configuration to be configured between the standard rear inlet design or, from the underside of the unit.
- Built-in high-lift drain pump.
- Air discharge spigot available as an option.

CAPACITY



1.7kW > 18kW

SOUND PRESSURE LEVEL



23dB(A)

OUTDOOR UNITS



Side Blow & MiNi SMMS-e



SMMS-u



SMMS-e & SHRM-e

LOCAL CONTROLS



RBC-AXU31-E



RBC-AMSU51E-ES(EN)
RBC-AMTU31-E
RBC-ASCU11-E

STANDARD DUCT Performances

Indoor unit	MMD- UP0051BHP-E/TR	UP0071BHP-E/TR	UP0091BHP-E/TR	UP0121BHP-E/TR	UP0151BHP-E/TR	UP0181BHP-E/TR	UP0241BHP-E/TR	UP0271BHP-E/TR	UP0301BHP-E/TR	UP0361BHP-E/TR	UP0481BHP-E/TR	UP0561BHP-E/TR	
Cooling capacity	kW	1,7	2,2	2,8	3,6	4,5	5,6	7,1	8,0	9,0	11,2	14,0	16,0
Heating capacity	kW	1,9	2,5	3,2	4,0	5,0	6,3	8,0	9,0	10,0	12,5	16,0	18,0
Power consumption	kW	0,055	0,055	0,060	0,060	0,110	0,110	0,135	0,135	0,160	0,220	0,290	0,290
Running current	A	0,35	0,35	0,38	0,38	0,70	0,70	0,80	0,80	0,95	1,29	1,70	1,70
Starting current	A	0,75	0,75	0,64	0,64	1,24	1,24	1,58	1,58	1,78	2,19	2,66	2,66

STANDARD DUCT Physical data

Indoor unit	MMD- UP0051BHP-E/TR	UP0071BHP-E/TR	UP0091BHP-E/TR	UP0121BHP-E/TR	UP0151BHP-E/TR	UP0181BHP-E/TR	UP0241BHP-E/TR	UP0271BHP-E/TR	UP0301BHP-E/TR	UP0361BHP-E/TR	UP0481BHP-E/TR	UP0561BHP-E/TR	
Air Flow (h/m/l)	m ³ /h	540/450/360	540/450/360	570/480/390	570/480/390	920/660/540	920/660/540	1320/1090/870	1320/1090/870	1450/1200/960	1920/1620/1380	2350/1920/1500	2350/1920/1500
Air Flow (h/m/l)	l/s	150/125/100	150/125/100	158/133/108	158/133/108	256/183/150	256/183/150	367/303/242	367/303/242	403/333/267	533/450/383	653/533/417	653/533/417
Sound pressure level (h/m/l)	dB(A)	29/26/23	29/26/23	30/26/23	30/26/23	33/29/25	33/29/25	33/30/27	33/30/27	36/31/27	36/34/31	40/36/33	40/36/33
Sound power level (h)	dB(A)	51	51	52	52	55	55	58	58	58	63	63	63
Dimensions (HxWxD)	mm	275x700x750	275x700x750	275x700x750	275x700x750	275x700x750	275x700x750	275x1000x750	275x1000x750	275x1000x750	275x1400x750	275x1400x750	275x1400x750
Weight	kg	23	23	23	23	23	23	30	30	30	40	40	40
External static pressure	Pa	30	30	30	30	30	30	40	40	40	50	50	50
Max external static pressure	Pa	150	150	150	150	150	150	150	150	150	150	150	150
Connecting pipe, gas	in	3/8"	3/8"	3/8"	3/8"	1/2"	1/2"	5/8"	5/8"	5/8"	5/8"	5/8"	5/8"
Connecting pipe, liquid	in	1/4"	1/4"	1/4"	1/4"	1/4"	1/4"	3/8"	3/8"	3/8"	3/8"	3/8"	3/8"
Drain port diameter	mm	25	25	25	25	25	25	25	25	25	25	25	25
Power supply	V _{ph} -Hz	220/240-1-50	220/240-1-50	220/240-1-50	220/240-1-50	220/240-1-50	220/240-1-50	220/240-1-50	220/240-1-50	220/240-1-50	220/240-1-50	220/240-1-50	220/240-1-50

MMD-UP_SPHY
SLIM DUCT

> NEW

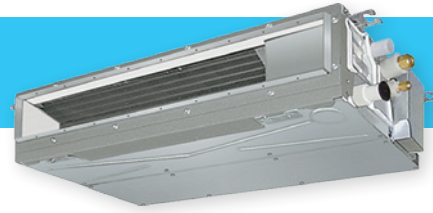

Whatever installed in a ceiling void or suspended ceiling, Toshiba slim duc offers the best compromise between sound level, air flow and chassis dimensions.

Flexibility

- Compact chassis with 210mm height and 450mm depth whatever the capacity, for integration in most projects.
- Capacity from 0.3HP for high efficiency buildings.
- Static pressure up to 50Pa set directly on the duct or by using a wired remote controller.

Comfort

- Quiet operation with a noise level down to 25 dB(A) perfect for bedrooms.
- 5-speed fan operation for perfect air flow adaptation.

Easy installation

- Built-in drain pump.
- Air suction from rear or bottom.

CAPACITY



0.9kW > 8kW

SOUND PRESSURE LEVEL



25dB(A)

OUTDOOR UNITS



Side Blow & Mini SMMS-e



SMMS-u



SMMS-e & SHRM-e

LOCAL CONTROLS



RBC-AXU31-E



RBC-AMTU31-E
RBC-AMTU31-E
RBC-ASCU11-E

SLIM DUCT Performances

Indoor unit	MMD-	UP0031SPHY-E	UP0051SPHY-E	UP0071SPHY-E	UP0091SPHY-E	UP0121SPHY-E	UP0151SPHY-E	UP0181SPHY-E	UP0241SPHY-E	UP0271SPHY-E	
Cooling capacity	kW	0,9	1,7	2,2	2,8	3,6	4,5	5,6	7,1	8,0	
Heating capacity	kW	1	1,9	2,5	3,2	4,0	5,0	6,3	8,0	9,0	
Factory setting	Power consumption	kW	0.018 / 0.018	0.020 / 0.020	0.026 / 0.026	0.029 / 0.029	0.031 / 0.031	0.035 / 0.035	0.044 / 0.044	0.067 / 0.067	0.072 / 0.072
	Running current	A	0.34 / 0.36	0.36 / 0.37	0.40 / 0.42	0.42 / 0.44	0.44 / 0.46	0.47 / 0.49	0.53 / 0.56	0.69 / 0.73	0.74 / 0.78
	Starting current	A	0.60 / 0.63	0.62 / 0.65	0.69 / 0.73	0.73 / 0.77	0.77 / 0.81	0.82 / 0.86	0.92 / 0.97	1.21 / 1.27	1.30 / 1.36
Standard ESP UP003-018:30Pa UP024-027:40Pa	Power consumption	kW	0.024 / 0.024	0.026 / 0.026	0.035 / 0.035	0.038 / 0.038	0.043 / 0.043	0.046 / 0.046	0.054 / 0.054	0.086 / 0.086	0.092 / 0.092
	Running current	A	0.37 / 0.39	0.40 / 0.41	0.46 / 0.48	0.48 / 0.50	0.52 / 0.54	0.54 / 0.57	0.60 / 0.63	0.83 / 0.87	0.88 / 0.93
	Starting current	A	0.65 / 0.69	0.69 / 0.73	0.81 / 0.85	0.84 / 0.88	0.90 / 0.95	0.95 / 0.99	1.04 / 1.10	1.45 / 1.53	1.54 / 1.62

SLIM DUCT Physical data

Indoor unit	MMD-	UP0031SPHY-E	UP0051SPHY-E	UP0071SPHY-E	UP0091SPHY-E	UP0121SPHY-E	UP0151SPHY-E	UP0181SPHY-E	UP0241SPHY-E	UP0271SPHY-E
Air Flow (H/M+/M/L+/L)	m³/h	410/390/370/ 360/350	450/430/410/ 390/380	540/500/460/ 430/400	570/530/500/ 450/420	600/550/520/ 470/440	690/660/640/ 590/550	780/760/730/ 690/650	1080/1010/950/ 900/860	1140/1060/980/ 940/910
Air Flow (H/M+/M/L+/L)	l/s	114/108/103/ 100/97	125/119/114/ 108/106	150/139/128/ 119/111	158/147/139/ 125/117	167/153/144/ 131/122	192/183/178/ 164/153	217/211/203/ 192/181	300/281/264/ 250/239	317/294/272/ 261/253
Sound pressure level*, rear suction (H/M+/M/L+/L)	dB(A)	29/28/27/26/25	30/29/28/27/26	31/30/29/28/26	32/31/29/28/26	33/32/30/29/27	33/31/30/29/28	34/33/32/31/29	36/35/33/32/30	37/36/34/33/32
Sound pressure level*, bottom suction (H/M+/M/L+/L)	dB(A)	37/36/35/34/32	39/38/37/35/34	41/40/39/38/35	42/41/40/38/36	44/42/40/39/37	42/40/39/38/37	44/43/42/41/39	47/46/44/43/41	48/47/45/44/43
Sound power level* (H/M+/M/L+/L)		46/45/44/43/42	49/47/46/45/44	52/51/49/47/45	54/52/50/48/46	54/51/50/48/46	52/51/50/49/46	56/55/54/52/51	60/58/56/55/53	61/59/58/56/55
Dimensions (HxWxD)	mm	210x700x450				210x900x450			210x1110x450	
Weight	kg	16				18			21	
External static pressure	Pa	10	10	10	10	10	10	10	10	10
Max external static pressure	Pa	50	50	50	50	50	50	50	50	50
Connecting pipe, gas		3/8"	3/8"	3/8"	3/8"	3/8"	1/2"	1/2"	5/8"	5/8"
Connecting pipe, liquid		1/4"	1/4"	1/4"	1/4"	1/4"	1/4"	1/4"	3/8"	3/8"
Drain port diameter	mm	25	25	25	25	25	25	25	25	25
Power supply	V-ph-Hz	220/240-1-50	220/240-1-50	220/240-1-50	220/240-1-50	220/240-1-50	220/240-1-50	220/240-1-50	220/240-1-50	220/240-1-50

* Factory setting (10Pa)

MMD-UP_HP
HIGH STATIC PRESSURE DUCT



sizes 18 to 56



sizes 72 & 96

This is Toshiba's most powerful ducted unit delivering air flows up to 4800m³/h with an external static pressure up to 250 Pa.

Comfort

- This ultra-flexible, invisible and silent unit creates a pleasant and comfortable environment for a wide range of applications, such as hotels, offices and shops.
- Diffuser design flexibility to select the right layout for the room shape and end user requirements.

Adaptability

- Unobtrusive, flexible and compact (298mm depth), it can be installed easily and discretely into any interior, making it the ideal solution for both new and refurbishing projects.
- Static pressure can be set to 7 levels from 50 to 250Pa.

Healthy

- Renewal of indoor ambient air with the constant fresh air supply via the field installed fresh air intake connection.
- Long-life filter and air discharge spigot available as an option.
- Built-in high-lift drain pump (sizes 18 to 56).

CAPACITY



5.6kW >31.5kW

SOUND PRESSURE LEVEL



37dB(A)

OUTDOOR UNITS



Side Blow & MiNi SMMS-e



SMMS-u



SMMS-e & SHRM-e

LOCAL CONTROLS



RBC-AXU31-E



RBC-AMSU51E-ES(EN)
RBC-AMTU31
RBC-ASCU11-E

HIGH STATIC PRESSURE DUCT Performances

Indoor unit	MMD-	UP0181HP-E/TR	UP0241HP-E/TR	UP0271HP-E/TR	UP0361HP-E/TR	UP0481HP-E/TR	UP0561HP-E/TR	UP0726HP-E/TR	UP0966HP-E/TR
Cooling capacity	kW	5,6	7,1	8,0	11,2	14,0	16,0	22,4	28,0
Heating capacity	kW	6,3	8,0	9,0	12,5	16,0	18,0	25,0	31,5
Power consumption	kW	0,125	0,140	0,190	0,230	0,300	0,400	0,540	0,790
Running current	A	0,82	0,92	1,16	1,39	1,81	2,48	2,83	3,77
Starting current	A	1,43	1,55	1,86	2,02	2,57	3,25	4,90	6,74

HIGH STATIC PRESSURE DUCT Physical data

Indoor unit	MMD-	UP0181HP-E/TR	UP0241HP-E/TR	UP0271HP-E/TR	UP0361HP-E/TR	UP0481HP-E/TR	UP0561HP-E/TR	UP0726HP-E/TR	UP0966HP-E/TR
Air Flow (h/m/l)	m ³ /h	1100/990/900	1200/1050/960	1500/1350/1200	1920/1560/1340	2340/1980/1695	2760/2340/1920	3800/3200/2500	4800/4200/3500
Air Flow (h/m/l)	l/s	306/275/250	333/292/267	417/375/333	533/433/372	650/550/471	767/650/533	1056/889/694	1333/1167/972
Sound pressure level (h/m/l)	dB(A)	37/33/31	38/34/31	43/41/38	41/37/34	44/41/38	46/44/41	44/40/36	46/42/38
Sound power level (h/m/l)	dB(A)	60/54/50	60/55/51	60/55/51	62/57/53	65/62/54	68/64/56	79	81
Dimensions (HxWxD)	mm	298x1000x750	298x1000x750	298x1000x750	298x1400x750	298x1400x750	298x1400x750	448x1400x900	448x1400x900
Weight	kg	34	34	34	43	43	43	97	97
External static pressure	Pa	100	100	100	100	100	100	150	150
Max external static pressure	Pa	200	200	200	200	200	200	250	250
Connecting pipe, gas	in	1/2"	5/8"	5/8"	5/8"	5/8"	5/8"	7/8"	7/8"
Connecting pipe, liquid	in	1/4"	3/8"	3/8"	3/8"	3/8"	3/8"	1/2"	1/2"
Drain port diameter	mm	25	25	25	25	25	25	25	25
Power supply	V-ph-Hz	220/240-1-50	220/240-1-50	220/240-1-50	220/240-1-50	220/240-1-50	220/240-1-50	220/240-1-50	220/240-1-50

MMC-UP_HP UNDER CEILING



The simple, yet elegant design helps to create a pleasant and relaxing environment, quickly conditioning the room air to the desired temperature.

Comfort

- Optimum louver control: air flow angle is automatically set to the most suitable setting according to your cooling or heating needs, and an automatic swing mode enables air flow to reach all areas in the room.
- High air flow distance up to 8m.
- Low noise levels, thanks to high diameter fan and DC motor.

Adaptability

- This design, represents the best possible solution, where there is a lack of space or absence of a ceiling void.
- The simplicity of the design and the installations of the unit, makes it suited for a wide range of applications, but particularly refurbishment projects.

Reliability

- Self-cleaning function, enables the air flow to remain constant and fresh and reduces the frequency of service visits.
- Drain pump available as an option.

CAPACITY



4.5kW > 18kW

SOUND PRESSURE LEVEL



28dB(A)

OUTDOOR UNITS



Side Blow & Mini SMMS-e



SMMS-u



SMMS-e & SHRM-e

LOCAL CONTROLS



RBC-AXU31C-E
RBC-AXU31-E



RBC-AMSU51E-ES(EN)
RBC-AMTU31-E
RBC-ASCU11-E

UNDER CEILING Performances

Indoor unit	MMC-	UP0151HP-E	UP0181HP-E	UP0241HP-E	UP0271HP-E	UP0361HP-E	UP0481HP-E	UP0561HP-E
Cooling capacity	kW	4,5	5,6	7,1	8,0	11,2	14,0	16,0
Heating capacity	kW	5,0	6,3	8,0	9,0	12,5	16,0	18,0
Power consumption	kW	0,033	0,034	0,067	0,067	0,083	0,083	0,111
Running current	A	0,38	0,39	0,68	0,68	0,80	0,80	1,03
Starting current	A	0,54	0,55	0,97	0,97	1,16	1,16	1,49

UNDER CEILING Physical data

Indoor unit	MMC-	UP0151HP-E	UP0181HP-E	UP0241HP-E	UP0271HP-E	UP0361HP-E	UP0481HP-E	UP0561HP-E
Air Flow (h/m/l)	m ³ /h	840/690/540	960/720/540	1440/1020/750	1440/1020/750	1860/1350/1020	1860/1530/1200	2040/1650/1260
Air Flow (h/m/l)	l/s	233/192/150	267/200/150	400/283/208	400/283/208	517/375/283	517/425/333	567/458/350
Sound pressure level (h/m/l)	dB(A)	36/34/28	37/35/28	41/36/29	41/36/29	44/38/32	44/41/35	46/42/36
Sound power level (h)	dB(A)	51	52	56	56	59	59	61
Dimensions (HxWxD)	mm	235x950x690	235x950x690	235x1270x690	235x1270x690	235x1586x690	235x1586x690	235x1586x690
Weight	kg	24	24	30	30	39	39	39
Connecting pipe, gas	in	1/2"	1/2"	5/8"	5/8"	5/8"	5/8"	5/8"
Connecting pipe, liquid	in	1/4"	1/4"	3/8"	3/8"	3/8"	3/8"	3/8"
Drain port diameter	mm	20	20	20	20	20	20	20
Power supply	V-ph-Hz	220/240-1-50	220/240-1-50	220/240-1-50	220/240-1-50	220/240-1-50	220/240-1-50	220/240-1-50

MML-AP_NH
BI-FLOW CONSOLE



Innovative and compact unit to be installed on the floor and in low wall applications, fits perfectly under the window sills or in a low ceiling attic.

Comfort

- Unique floor heating function to deliver a powerful flow at floor level for a uniform and comfortable room heating
- Compact and modern design in all three dimensions (60x70x22cm); single size for all range capacities.
- Bi-flow. Two outlets for complete personalized flow: flow intensity and air direction control.

Healthy

- Toshiba IAQ filter filtration system, includes extremely powerful components and deodorizing effects.
- Ultra pure filter (818F0050) available as an option to ensure healthy and pleasant atmosphere.

Control

- Brightness level control of the display unit to reduce the led light glow.
- Wireless remote control with a pre-set function and a unique hi-power button for immediate and fast air delivery.

CAPACITY



2.2kW > 6.3kW

SOUND PRESSURE LEVEL



26dB(A)

OUTDOOR UNITS



Side Blow & Mini SMMS-e



SMMS-u



SMMS-e & SHRM-e

LOCAL CONTROLS



IR control (included)



RBC-AMSU51E-ES(EN)
RBC-AMTU31-E
RBC-ASCU11-E

BI-FLOW CONSOLE Performances

Indoor unit	MML-	UP0071NHP-E/TR	UP0091NHP-E/TR	UP0121NHP-E/TR	UP0151NHP-E/TR	UP0181NHP-E/TR
Cooling capacity	kW	2,2	2,8	3,6	4,5	5,6
Heating capacity	kW	2,5	3,2	4,0	5,0	6,3
Power consumption	kW	0,021	0,021	0,025	0,034	0,052
Running current	A	0,20	0,20	0,23	0,29	0,42
Starting current	A	0,26	0,26	0,30	0,38	0,55

BI-FLOW CONSOLE Physical data

Indoor unit	MML-	UP0071NHP-E/TR	UP0091NHP-E/TR	UP0121NHP-E/TR	UP0151NHP-E/TR	UP0181NHP-E/TR
Air Flow (h/m/l)	m ³ /h	510/366/282	510/366/282	552/408/324	624/468/384	726/528/426
Air Flow (h/m/l)	l/s	142/102/78	142/102/78	153/113/90	173/130/107	202/147/118
Sound pressure level (h/m/l)	dB(A)	38/32/26	38/32/26	40/34/29	43/37/31	47/40/34
Sound power level (h/m/l)	dB(A)	53/47/41	53/47/41	55/49/44	58/52/46	62/55/49
Dimensions (HxWxD)	mm	600x700x220	600x700x220	600x700x220	600x700x220	600x700x220
Weight	kg	17	17	17	17	17
Connecting pipe, gas		3/8"	3/8"	3/8"	1/2"	1/2"
Connecting pipe, liquid		1/4"	1/4"	1/4"	1/4"	1/4"
Drain port diameter	mm	16	16	16	16	16
Power supply	V-ph-Hz	220/240-1-50	220/240-1-50	220/240-1-50	220/240-1-50	220/240-1-50



The simple design of this unit represents the perfect choice, for refurbishment projects, where the available space is limited, or where neither the walls nor ceiling are able to house the unit.

Comfort

- The units have as standard the ability to flow air in a horizontal direction, however with a simple change during the installation process, the unit can be configured, so that the air flow goes in the upward direction, maximising the flexibility of the design.

Adaptability

- With just one single cabinet size, for all capacity models, allows a single model range to be installed within a building, giving the installation a uniform and clean look.
- Minimum space required for installation and servicing.
- Refrigerant and drain piping with four installation possibilities: top, rear, left or right hand of the unit.

CAPACITY



2.2kW > 8kW

SOUND PRESSURE LEVEL



35dB(A)

OUTDOOR UNITS



Side Blow & Mini SMMS-e



SMMS-u



SMMS-e & SHRM-e

LOCAL CONTROLS



RBC-AXU31-E



RBC-AMSU51E-ES(EN)
RBC-AMTU31-E
RBC-ASCU11-E

CONSOLE Performances

Indoor unit	MML-	UP0071H-E/TR	UP0091H-E/TR	UP0121H-E/TR	UP0151H-E/TR	UP0181H-E/TR	UP0241H-E/TR
Cooling capacity	kW	2,2	2,8	3,6	4,5	5,6	7,1
Heating capacity	kW	2,5	3,2	4,0	5,0	6,3	8,0
Power consumption	kW	0,056	0,056	0,092	0,092	0,102	0,102
Running current	A	0,26	0,26	0,43	0,43	0,47	0,47
Starting current	A	0,60	0,60	0,80	0,80	1,10	1,10

CONSOLE Physical data

Indoor unit	MML-	UP0071H-E/TR	UP0091H-E/TR	UP0121H-E/TR	UP0151H-E/TR	UP0181H-E/TR	UP0241H-E/TR
Air Flow (h/m ³ /l)	m ³ /h	480/420/360	480/420/360	900/780/650	900/780/650	1080/930/780	1080/930/780
Air Flow (h/m ³ /l)	l/s	133/117/100	133/117/100	250/217/181	250/217/181	300/258/217	300/258/217
Sound pressure level (h/m ³ /l)	dB(A)	39/37/35	39/37/35	45/41/38	45/41/38	49/44/39	49/44/39
Sound power level (h)	dB(A)	54	54	60	60	64	64
Dimensions (HxWxD)	mm	630x950x230	630x950x230	630x950x230	630x950x230	630x950x230	630x950x230
Weight	kg	37	37	37	37	40	40
Connecting pipe, gas		3/8"	3/8"	3/8"	1/2"	1/2"	5/8"
Connecting pipe, liquid		1/4"	1/4"	1/4"	1/4"	1/4"	3/8"
Drain port diameter	mm	20	20	20	20	20	20
Power supply	V-ph-Hz	220/240-1-50	220/240-1-50	220/240-1-50	220/240-1-50	220/240-1-50	220/240-1-50

MML-UP_BH
CONCEALED CONSOLE



This unit has been designed to be fitted easily into a compact space behind a decorative panel, allowing the unit to blend into any room interior. This chassis is compact and slim, it is very easy to install and to conceal behind a decorative panel to blend with any room interior.

Specialized

- Not only is this unit ideal for office and other commercial buildings, it fits perfectly for specialist applications such as a library or hospital building.

Easy to hidden

- Very compact design, which can be installed under a window sill, that is only 600mm in height.
- With its limited depth of only 200mm, the unit can be installed along the wall ensuring maximum space saving.

Accessibility

- Removable split front panel with immediate access to the main components.

CAPACITY



2.2kW > 8kW

SOUND PRESSURE LEVEL



32dB(A)

OUTDOOR UNITS



Side Blow & MiNi SMMS-e



SMMS-u



SMMS-e & SHRM-e

LOCAL CONTROLS



RBC-AXU31-E



RBC-AMSU51E-ES(EN)
RBC-AMTU31-E
RBC-ASCU11-E

CONCEALED CONSOLE Performances

Indoor unit	MML-	UP0071BH-E/TR	UP0091BH-E/TR	UP0121BH-E/TR	UP0151BH-E/TR	UP0181BH-E/TR	UP0241BH-E/TR
Cooling capacity	kW	2,2	2,8	3,6	4,5	5,6	7,1
Heating capacity	kW	2,5	3,2	4,0	5,0	6,3	8,0
Power consumption	kW	0.056	0.056	0.056	0.090	0.090	0.095
Running current	A	0.25	0.25	0.25	0.45	0.45	0.46
Starting current	A	0.60	0.60	0.60	0.80	0.80	1,00

CONCEALED CONSOLE Physical data

Indoor unit	MML-	UP0071BH-E/TR	UP0091BH-E/TR	UP0121BH-E/TR	UP0151BH-E/TR	UP0181BH-E/TR	UP0241BH-E/TR
Air Flow (h/m/l)	m ³ /h	460/400/300	460/400/300	460/400/300	740/600/490	740/600/490	950/790/640
Air Flow (h/m/l)	l/s	128/111/83	128/111/83	128/111/83	206/167/136	206/167/136	264/219/178
Sound pressure level (h/m/l)	dB(A)	36/34/32	36/34/32	36/34/32	36/34/32	36/34/32	42/37/33
Sound power level (h)	dB(A)	54	54	54	54	54	60
Dimensions (HxWxD)	mm	600x745x220	600x745x220	600x745x220	600x1045x220	600x1045x220	600x1045x220
Weight	kg	21	21	21	29	29	29
Connecting pipe, gas		3/8"	3/8"	3/8"	1/2"	1/2"	5/8"
Connecting pipe, liquid		1/4"	1/4"	1/4"	1/4"	1/4"	3/8"
Drain port diameter	mm	20	20	20	20	20	20
Power supply	V-ph-Hz	220/240-1-50	220/240-1-50	220/240-1-50	220/240-1-50	220/240-1-50	220/240-1-50

MMF-UP_H FLOOR STANDING



This system is particularly suitable to air condition large rooms like shops or showrooms or with low ceilings like restaurants or lofts.

Optimized air flow

- The unit has been designed to have particularly high air flow rates, which correspond into superior air throw values.
- The wide and automatic vertical and horizontal air distribution angles, allow the air flow distribution to reach all areas, even when installed into large rooms.
- High air flows: from 180 l/s to 600 l/s (660 m³/h to 2160 m³/h).
- Wide air distribution angle: up to 150°.

Wide range

- Large capacity range: cooling capacities from 4.5 kW to 16 kW and heating capacities from 5 kW to 18 kW.

Installation everywhere

- The unit can be installed in the corner of the room, in this case the automatic swing angle can be fixed to deliver the air only where it is needed.
- Very small footprint: 0.128 m² up to 8 kW and 0.243 m² up to 16 kW.



CAPACITY



4.5kW > 18kW

SOUND PRESSURE LEVEL



37dB(A)

OUTDOOR UNITS



Side Blow
& Mini SMMS-e



SMMS-u



SMMS-e
& SHRM-e

LOCAL CONTROLS



RBC-AXU31-E



RBC-AMSU51E-ES(EN)
RBC-AMTU31-E
RBC-ASCU1U1-E

FLOOR STANDING Performances

Indoor unit	MMF-	UP0151H-E/TR	UP0181H-E/TR	UP0241H-E/TR	UP0271H-E/TR	UP0361H-E/TR	UP0481H-E/TR	UP0561H-E/TR
Cooling capacity	kW	4,5	5,6	7,1	8,0	11,2	14,0	16,0
Heating capacity	kW	5,0	6,3	8,0	9,0	12,5	16,0	18,0
Power consumption	kW	0,055	0,055	0,089	0,089	0,135	0,160	0,160
Running current	A	0,38	0,38	0,60	0,60	0,90	1,10	1,10
Starting current	A	0,53	0,53	0,84	0,84	1,26	1,54	1,54

FLOOR STANDING Physical data

Indoor unit	MMF-	UP0151H-E/TR	UP0181H-E/TR	UP0241H-E/TR	UP0271H-E/TR	UP0361H-E/TR	UP0481H-E/TR	UP0561H-E/TR
Air Flow (h/m/l)	m ³ /h	900/780/660	900/780/660	1200/990/840	1200/990/840	1920/1620/1380	2160/1730/1560	2160/1730/1560
Air Flow (h/m/l)	l/s	250/217/183	250/217/183	333/275/233	333/275/233	533/450/383	600/481/433	600/481/433
Sound pressure level (h/m/l)	dB(A)	46/42/37	46/42/37	49/45/39	49/45/39	51/46/41	54/49/44	54/49/44
Sound power level (h)	dB(A)	64	64	67	67	69	72	72
Dimensions (HxWxD)	mm	1750x600x210	1750x600x210	1750x600x210	1750x600x210	1750x600x390	1750x600x390	1750x600x390
Weight	kg	46	46	47	47	62	62	62
Connecting pipe, gas	in	1/2"	1/2"	1/2"	5/8"	5/8"	5/8"	5/8"
Connecting pipe, liquid	in	1/4"	1/4"	1/4"	3/8"	3/8"	3/8"	3/8"
Drain port diameter	mm	20	20	20	20	20	20	20
Power supply	V-ph-Hz	220/240-1-50	220/240-1-50	220/240-1-50	220/240-1-50	220/240-1-50	220/240-1-50	220/240-1-50

MMK-UP_HP(L)
HIGH-WALL (STD & WITHOUT PMV)



Particularly compact, this high-wall is perfect for limited spaces, such as offices or small shops.

Compact and design

- The unit is compact and lightweight, it is perfect for installation above the doors or in narrow corridors.
- New appearance, simple, elegant with nice led display.

Healthy

- Special fin coating for Healthy & Fresh air.
- Ultra pure filter (818F0050) available as an option to ensure healthy and pleasant atmosphere.

Easy to use

- Remote controller for easy access to the preferred setting.
- Filters for dust collection can be easily removed by lifting the front panel and can be cleaned easily washing them under running water.

> NEW SIZES 0.3HP & 4HP

CAPACITY



1.7kW > 11.2kW

SOUND PRESSURE LEVEL



25dB(A)

OUTDOOR UNITS



Side Blow & Mini SMMS-e



SMMS-u



SMMS-e & SHRM-e

LOCAL CONTROLS



IR control (included)



RBC-AMSU51E-ES(EN)
RBC-AMTU31-E
RBC-ASCU11-E

HIGH-WALL Performances

PRELIMINARY DATA

Indoor unit	With PMV	MMK- UP0031HP-E/TR	UP0051HP-E/TR	UP0071HP-E/TR	UP0091HP-E/TR	UP0121HP-E/TR	UP0151HP-E/TR	UP0181HP-E/TR	UP0241HP-E/TR	UP0271HP-E/TR	UP0301HP-E/TR	UP0361HP-E/TR
	Without PMV*	MMK- UP0031HPL-E/TR	UP0051HPL-E/TR	UP0071HPL-E/TR	UP0091HPL-E/TR	UP0121HPL-E/TR	UP0151HPL-E/TR	UP0181HPL-E/TR	UP0241HPL-E/TR	UP0271HPL-E/TR	UP0301HPL-E/TR	UP0361HPL-E/TR
Cooling capacity	kW	0.9	1.7	2.2	2.8	3.6	4.5	5.6	7.1	8.0	9	10
Heating capacity	kW	1.3	1.9	2.5	3.2	4.0	5.0	6.3	8.0	9.0	10	11.2
Power consumption	kW	0.013	0.013	0.015	0.016	0.017	0.028	0.032	0.050	-	-	-
Running current	A	0.15	0.15	0.16	0.17	0.18	0.26	0.29	0.40	0.030	0.05	0.06
Starting current	A	0.19	0.19	0.20	0.21	0.22	0.35	0.38	0.50	-	-	-

HIGH-WALL Physical data

Indoor unit	With PMV	MMK- UP0031HP-E/TR	UP0051HP-E/TR	UP0071HP-E/TR	UP0091HP-E/TR	UP0121HP-E/TR	UP0151HP-E/TR	UP0181HP-E/TR	UP0241HP-E/TR	UP0271HP-E/TR	UP0301HP-E/TR	UP0361HP-E/TR
	Without PMV*	MMK- UP0031HPL-E/TR	UP0051HPL-E/TR	UP0071HPL-E/TR	UP0091HPL-E/TR	UP0121HPL-E/TR	UP0151HPL-E/TR	UP0181HPL-E/TR	UP0241HPL-E/TR	UP0271HPL-E/TR	UP0301HPL-E/TR	UP0361HPL-E/TR
Air Flow (h/m/l)	m ³ /h	455/370/270	455/370/270	480/385/270	510/395/270	540/410/270	840/690/550	900/720/550	1200/900/600	1200/1000/800	1450/1300/1100	1650/1350/1250
Air Flow (h/m/l)	l/s	126/103/75	126/103/75	133/107/75	141/110/75	150/114/75	233/192/153	250/200/153	333/250/167	333/277/222	403/361/305	458/375/347
Sound pressure level (h/m/l)	dB(A)	33/29/25	33/29/25	35/33/30/28/25	36/34/31/28/25	37/35/32/28/25	40/38/36/34/32	41/39/37/35/32	45/42/39/36/33	45/41/39	48/44/41	50/45/43
Sound power level (h)	dB(A)	48	48	50	51	52	55	56	60	-	-	-
Dimensions (HxWxD)	mm	293x798x230	293x798x230	293x798x230	293x798x230	293x798x230	320x1050x250	320x1050x250	320x1050x250	350x1200x280	350x1200x280	350x1200x280
Weight	kg	11	11	11	11	11	16	16	16	20	20	20
Connecting pipe, gas		3/8"	3/8"	3/8"	3/8"	3/8"	1/2"	1/2"	5/8"	5/8"	5/8"	5/8"
Connecting pipe, liquid		1/4"	1/4"	1/4"	1/4"	1/4"	1/4"	1/4"	3/8"	3/8"	3/8"	3/8"
Drain port diameter	mm	16	16	16	16	16	16	16	16	16	16	16
Power supply	V-ph-Hz	220/240-1-50	220/240-1-50	220/240-1-50	220/240-1-50	220/240-1-50	220/240-1-50	220/240-1-50	220/240-1-50	220/240-1-50	220/240-1-50	220/240-1-50

*Optional PMV-Kit needed.
Size 0.3HP compatible with SMMS-u only.

VN-M_HE AIR-TO-AIR HEAT EXCHANGER



Toshiba's VN model uses exhaust air to pre-condition the incoming air, thus reducing the cooling or heating load on the system. This allows the overall capacity size of the system to be reduced.

Energy savings

- Recovers air suction heat and humidity up to 75% and transfers them to the outdoor fresh air.
- The unit has the ability to automatically change operation mode of the air flow between heat exchanger mode (energy recovery) to normal standard ventilation mode (free cooling), based on the outdoor temperatures.
- Free cooling - Provides fresh outdoor cool air to reduce the indoor air temperature, when the outdoor temperature is lower than the indoor air conditioned temperature.

Multi-application

- 9 models available with air flow ranges from 150 to 2000 m³/h.
- Air balance volume rate can be varied to suit the usage environment and location.
- Horizontal or upside down installations.

Fully integrated

- Air conditioners and heat exchangers are controlled with the same main bus system (TCC-LINK).

AIR FLOW



150m³/h > 2000m³/h

SOUND PRESSURE LEVEL



20dB(A)

OUTDOOR UNITS



Side Blow
& Mini SMMS-e



SMMS-u



SMMS-e
& SHRM-e

LOCAL CONTROLS



RBC-AMTU31-E

AIR-TO-AIR HEAT EXCHANGER Performance and physical data

Model		VN-M150HE	VN-M250HE	VN-M350HE	VN-M500HE	VN-M650HE	VN-M800HE	VN-M1000HE1	VN-M1500HE 1	VN-M2000HE1
Air volume	(EH/H/L) m ³ /h	150/150/110	250/250/155	350/350/210	500/500/390	650/650/520	800/800/700	1000/1000/700	1500/1500/1200	2000/2000/1400
Temp. exchange efficiency	(EH/H/L) %	81.5/81.5/83	78/78/81.5	74.5/74.5/79.5	76.5/76.5/78	75/75/76.5	76.5/76.5/77.5	73.5/73.5/77	76.5/76.5/79	73.5/73.5/77.5
Enthalpy exchange efficiency (Heating)	(EH/H/L) %	74.5/74.5/76	70/70/74	65/65/71.5	72/72/73.5	69.5/69.5/71.5	71/71/71.5	68.5/68.5/71.5	71/71/73.5	68.5/68.5/72
Enthalpy exchange efficiency (Cooling)	(EH/H/L) %	69.5/69.5/71	65/65/69	60.5/60.5/67	64.5/64.5/66.5	61.5/61.5/64	64/64/65.5	60.5/60.5/64.5	64/64/67	60.5/60.5/65.5
Sound pressure level**	EH dB(A)	26-28	29.5-30	34-35	32.5-34	34-36	37-38.5	40.5	41.5	42.5
Sound pressure level**	H dB(A)	24-25.5	25-27	30-32	29.5-31	33-34	35.5-37	39.5	40	41.5
Sound pressure level*	L dB(A)	20-22	21-22	27-29	26-29	31-32.5	33.5-35	34.5	36	36.5
Power consumption**	EH (W)	68-78	123-138	165-182	214-238	262-290	360-383	396	590	792
Power consumption**	H (W)	59-67	99-111	135-145	176-192	240-258	339-353	374	500	748
Power consumption**	L (W)	42-47	52-59	82-88	128-142	178-191	286-300	220	310	440
External static pressure**	EH Pa	82-102	80-98	114-125	134-150	91-107	142-158	105	140	105
External static pressure**	H Pa	52-78	34-65	56-83	69-99	58-82	102-132	80	110	80
External static pressure**	L Pa	47-64	28-40	65-94	62-92	61-96	76-112	70	80	70
Dimensions (HxWxD)	mm	290x900x900	290x900x900	290x900x900	350x1140x1140	350x1140x1140	400x1189x1189	400x1189x1189	810x1189x1189	810x1189x1189
Weight	kg	36	36	38	53	53	70	58	130	130
Duct diameter	indoor side mm	100	150	150	200	200	250	250	250	250
Power supply	V-ph-Hz	220-240 - 1 - 50								
Operating range	Around unit	-10 / 40°C . RH ≤80%								
	Outdoor Air (OA)	-15 / 43°C . RH ≤80%								
	Return Air (RA)	5 / 40°C . RH ≤80%								

* Sound pressure level is measured 1.5m below the center of the unit.

** Sound pressure level, power consumption and external static pressure values at 220 - 240 V.

MMD-VN(K)
AIR-TO-AIR HEAT EXCHANGER WITH DX COIL



MMD-VN(K) ventilation products are using exhaust air + DX coil to pre-condition the incoming air, thus reducing the cooling or heating load and the overall size of the required air conditioning system.

Energy savings

- Recovers incoming heat and humidity up to 75% and transfers them to the outdoor fresh air.
- Up to 10kW coil capacity to reach intake air temperature close to ambient temperature: no extra load on the heating and cooling system
- Unit has the ability to automatically change operation mode of the air flow between heat exchanger mode (energy recovery) to normal standard ventilation mode (free cooling), based on the outdoor temperatures.
- Free cooling - Provides fresh outdoor cool air to reduce the indoor air temperature, when the outdoor temperature is lower than the indoor air conditioned temperature.

Multi-application

- 9 models available with air flow ranges from 150 to 2000 m³/h.
- Air balance volume rate can be varied to suit the usage environment and location.
- Version with humidifier is available for applications where humidity levels need to be controlled.

Fully integrated

- Air conditioners and heat exchangers are controlled with the same main bus system (TCC-LINK).

CAPACITY



4.1kW > 10.9kW

SOUND PRESSURE LEVEL



34dB(A)

AIR FLOW



500m³/h > 1000m³/h

OUTDOOR UNITS



MINI SMMS-e



SMMS-e



SHRM-e

LOCAL CONTROLS



RBC-AMTU31-E

AIR-TO-AIR HEAT EXCHANGER WITH DX COIL / WITH HUMIDIFIER Performance and physical data

Model	MMD-		VN502HEX1E/TR	VN802HEX1E/TR	VN1002HEX1E/TR	VNK502HEX1E/TR	VNK802HEX1E/TR	VNK1002HEX1E/TR
Fresh air conditioning capacity	CO	kW	4.10 (1.30)	6.56 (2.06)	8.25 (2.32)	4.10 (1.30)	6.56 (2.06)	8.25 (2.32)
Fresh air conditioning capacity	HP	kW	5.53 (2.33)	8.61 (3.61)	10.92 (4.32)	5.53 (2.33)	8.61 (3.61)	10.92 (4.32)
Air volume	(EH/H/L)	m ³ /h	500/500/440	800/800/640	950/950/820	500/500/440	800/800/640	950/950/820
Temperature exchange efficiency	(EH/H/L)	%	70.5/70.5/71.5	70/70/72.5	65.5/65.5/67.5	70.5/70.5/71.5	70/70/72.5	65.5/65.5/67.5
Enthalpy exchange efficiency (Heating)	(EH/H/L)	%	68.5/68.5/69	70/70/73	66/66/68.5	68.5/68.5/69	70/70/73	66/66/68.5
Enthalpy exchange efficiency (Cooling)	(EH/H/L)	%	56.5/56.5/57.5	56/56/59	52/52/54.0	56.5/56.5/57.5	56/56/59	52/52/54.5
Sound pressure level* ***	(EH/H/L)	dB(A)	37.5/36.5/34.5	41/40/38	43/42/40	36.5/35.5/33.5	40/39/38	42/41/39
Power consumption***	(EH/H/L)	W	300/280/235	505/465/335	550/545/485	305/285/240	530/485/350	575/565/520
External static pressure***	(EH/H/L)	Pa	120/105/115	120/100/100	135/120/105	95/85/95	105/85/90	110/90/115
Heat exchanger			Finned tube - R410A			Finned tube - R410A		
Gas line diameter		mm	9.5	12.7	12.7	9.5	12.7	12.7
Liquid line diameter		mm	6.4	6.4	6.4	6.4	6.4	6.4
Drain port diameter		mm	25	25	25	25	25	25
Humidifier technology			Permeable film humidifier					
water pressure			0.02 to 0.49					
water flow			3 5 6					
water supply			1/2" 1/2" 1/2"					
Dimensions (HxWxD)		mm	430x1140x1690	430x1189x1739	430x1189x1739	430x1140x1690	430x1189x1739	430x1189x1739
Weight		kg	84	100	101	91	111	112
Duct diameter	indoor side	mm	200	250	250	200	250	250
Power supply		V-ph-Hz	220-240 - 1 - 50			220-240 - 1 - 50		
Operating range	Around unit		-10 / 40°C . RH ≤80%			-10 / 40°C . RH ≤80%		
	Outdoor Air (OA)		-15 / 43°C . RH ≤80%			-15 / 43°C . RH ≤80%		
	Return Air (RA)		5 / 40°C . RH ≤80%			5 / 40°C . RH ≤80%		

* Sound pressure level is measured 1.5m below the center of the unit. *** Sound pressure level, power consumption and external static pressure values at 230 V. Cooling and heating capacities are based on the following conditions: Cooling capacities are based on: indoor temperature: 27°CDB/19°CWB, Outdoor temperature: 35°CDB. Heating capacities are based on: indoor temperature: 20°CDB, Outdoor temperature: 7 °CDB/6°CWB. The figures in () indicate the heat reclaimed from the heat recovery ventilator. EH/H/L = extra-high/high/low. C: cooling mode. H: heating mode

MMD-UP_HFP
FRESH AIR DUCT

> NEW

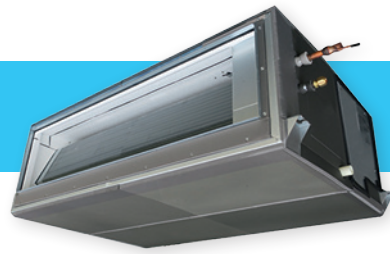

This indoor unit manages and treats the fresh air intake before it will be distributed into the building.

AHU alternative

- Ideal solution for all buildings that require fresh air ventilation.
- Air flow up to 3,060m³/h.
- Up to 200Pa available pressure, enough to create long pipe work.

Comfort

- Constant 20°C fresh air delivery from -10 to +46°C air suction temperature.
- 5-speed fan operation for perfect air flow adaptation.
- Filters available as an option.

Integration flexibility

- Make your choice between VRF 1:1 connection or mix with other indoor unit types.

CAPACITY



8.9kW > 40kW

AIR FLOW



1,080m³/h > 3,060m³/h

SOUND PRESSURE LEVEL



31dB

OUTDOOR UNITS



SMMS-e



SMMS-u

LOCAL CONTROLS



- RBC-AMSU51E-ES/EN
- RBC-AMTU31-E
- RBC-ASCU11-E

FRESH AIR INTAKE Performance

Indoor unit	MMD-	UP0481HFP-E/TR	UP0721HFP-E/TR	UP0961HFP-E/TR	UP1121HFP-E/TR	UP1281HFP-E/TR
Cooling capacity	kW	14,0	22,4	28,0	33,5	40,0
Heating capacity	kW	8,9	13,9	17,4	20,8	25,2
Power consumption	kW	0,110	0,160	0,200	0,250	0,330
Running current	A	0,77	0,86	1,07	1,30	1,83
Starting current	A	2,01	7,80	7,80	7,80	7,80

FRESH AIR INTAKE Physical data

Indoor unit	MMD-	UP0481HFP-E/TR	UP0721HFP-E/TR	UP0961HFP-E/TR	UP1121HFP-E/TR	UP1281HFP-E/TR
Air flow (h)	m ³ /h	1080/990/930/840/760	1680/1560/1440/1320/1200	2100/1950/1800/1620/1470	2520/2340/2130/1950/1770	3060/2820/2580/2370/2130
Air flow (h)	l/s	300/275/258/233/211	466/433/400/366/333	583/542/500/450/408	700/650/592/542/492	850/783/717/658/592
Sound pressure level	dB(A)	38/37/35/32/31	38/37/36/35/33	39/38/36/35/33	40/39/37/36/34	42/40/38/37/35
Dimensions (HxWxD)	mm	327x1430x750	477x1430x900	477x1430x900	477x1430x900	477x1430x900
Weight	kg	44	99	99	99	99
External static pressure	Pa			50/75/111/125/150/175/200		
External static pressure - factory setting	Pa	100	100	100	100	100
Connecting pipe, gas	in	5/8"	7/8"	7/8"	1"1/8	1"1/8
Connecting pipe, liquid	in	3/8"	1/2"	1/2"	1/2"	5/8"
Drain port diameter	mm	25	25	25	25	25
Power supply	V-ph-Hz	220/240-1-50	220/240-1-50	220/240-1-50	220/240-1-50	220/240-1-50
Operation range for SMMS-u	Cooling (*2)	°C		+5/+46 (Note 4)		
	Heating (*3)	°C		-10/46		
Operation range for SMMS-e	Cooling (*2)	°C		+5/+43		
	Heating (*3)	°C		-5/43		

* The setting temperature is 13 - 25°C (standard FCU.. 18 - 30 °C).

* Height difference between Fresh Air Intake Indoor units must be within 5 m.

Note 1: Rated conditions. Cooling : Outdoor air temperature 33°C DB/28°C WB setting 18°C. Heating : Outdoor air temperature 0°C DB/-2.9°C WB setting temperature 25°C.

Note 2: When supply air temperature is "setting temperature + 3°C" or less, Fresh Air Intake unit operates as FAN mode.

Note 3: When supply air temperature is "setting temperature -3°C" or over, Fresh Air Intake unit operates as FAN mode.

Note 4: 46-52°C is also available but temporary operable.

RBC-DXC
0/10V DX KIT



Control the capacity of the VRF Toshiba system directly from the air handling unit controller to maintain constant fresh air temperature intake inside the building: the ultimate fresh air solution.

Third party control

- 0/10v input for capacity and mode control: the AHU drives Toshiba VRF system.
- Output signal for defrost and failures: the AHU knows when Toshiba system is in trouble to avoid any troubles.

All year round comfort

- Air temperature control using AHU sensor to enlarge air stream temperature control possibilities.
- Operate in both cooling and heating modes.

Packaged solution

- DX kit composed of two parts: controller and valve kit.
- Delivered with temperature sensors.

Only compatible with SMMSe 8 and 10HP in 1:1 configuration!

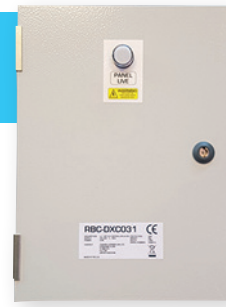

CAPACITY



16kW > 31.5kW

AIR FLOW



Up to 6000m³/h

OUTDOOR UNITS



SMMS-e

LOCAL CONTROLS



RBC-AMTU31-E

0/10V DX KIT

LC / VRF DX Coil Controller Unit	RBC-	DXC031	DXC031	DXC031
VRF DX PMV valve unit	MM-	DXV141	DXV281	DXV281
Cooling capacity	kW	16.0	22.4	28.0
Heating capacity	kW	18.0	25.0	31.5
Power code	HP	6.0	8.0	10.0

0/10V DX KIT Physical data

LC / VRF DX Coil Controller Unit	RBC-	DXC031	DXC031	DXC031
Minimum air flow rate	m³/h	2310	3010	3500
Maximum air flow rate	m³/h	3960	5160	6000
Dimensions (HxWxD)	mm	400x300x165	400x300x165	400x300x165
Weight	kg	8	8	8
Cable Max Length (Analogue Input) (Screened cable: 0.5 ~ 1.0 mm²)	m	200	200	200
Cable Max Length (Digital Input) (Non screened cable: 1.5 ~ 2.5 mm²)	m	100	100	100
Cable Max Length (Digital Output) (Non screened cable: 1.5 ~ 2.5 mm²)	m	500	500	500
Cable Max Length (TCC Link) (Screened cable: 1.5 ~ 2.5 mm²)	m	1000	1000	1000
Standard Rating	IP	65	65	65
Operating temperature/humidity	°C / RH	5-40 / 10-90	5-40 / 10-90	5-40 / 10-90
Operating range - Cooling coil "Air on" temp	°C	15°CWB±24°CWB	15°CWB±24°CWB	15°CWB±24°CWB
Operating range - Heating coil "Air on" temp	°C	12°CDB±28°CDB	12°CDB±28°CDB	12°CDB±28°CDB
System Diversity	%	75 - 100	75 - 100	75 - 100
Outdoor Unit		8HP SMMS-e Only	8HP or 10HP SMMS-e Only	10HP SMMS-e Only
Power supply		220 - 240V AC 50Hz	220 - 240V AC 50Hz	220 - 240V AC 50Hz

MM-DXC STANDARD DX KIT



Built an efficient and reliable ventilation system managed by Toshiba remote controller mixing third party AHU, DX coil and Toshiba VRF system.

Full Toshiba control

- On/Off fan, temperature control and safety cut managed by Toshiba system.
- Air temperature control achieved using TA sensor positioned in return air stream (set with remote controller).

High capacity, high air flow

- Up to 60HP capacity (master/slave DX kits), up to 30000 m³/h to be suitable for every type of project.

Packaged solution

- DX kit composed of two parts: controller and valve kit.
- Delivered with temperature sensors.

CAPACITY



5kW > 168kW

AIR FLOW



Up to 30000m³/h

OUTDOOR UNITS



MINI SMMS-e



SMMS-e



SHRM-e

LOCAL CONTROLS



BC-AMTU31-E

STANDARD DX KIT Physical data

DX Controller unit	MM-	DXC010 VRF DX COIL CONTROLLER (Individual / Header)	DXC012 VRF DX COIL CONTROLLER (Follower)
Dimensions (HxWxD)	mm	400x300x150	400x300x150
Weight	kg	8	7.6
Standard rating	IP	65	65
Operating temperature/humidity	°C / RH	5-40 / 10-90	5-40 / 10-90
Operating range - Cooling coil "Air on" temp	°C	15°CWB+24°CWB	15°CWB+24°CWB
Operating range - Heating coil "Air on" temp	°C	15°CDB+28°CDB	15°CDB+28°CDB
Power supply	V-ph-Hz	220/240-1-50	220/240-1-50

STANDARD DX KIT Physical data

DX valve kit	MM-	DXV080	DXV140	DXV280
Nominal capacity		5.6kW, 7.1kW, 8.0kW 1.7 - 3.2 HP	11.2kW, 14.0kW, 16.0kW 4 - 6HP	22.4kW, 28.0kW 8 - 10 HP
Dimensions	mm		155x155x185	
Weight	kg		0.9kg	
Integrated components		TA, TC1, TC & TCJ sensors, PMV, sensor holder 4 & 6 mm, fix plate, strainer and clamp (for TA)		

STANDARD DX KIT

STANDARD DX KIT Capacity table

Capacity in HP	VRF DX Coil controller (Individual/Header)	VRF DX Coil Controller (Follower)	VRF DX Coil valve kit			Nominal capacity (kW) ^{*3}		DX coil internal volume (cc)			Recommended liquid capillary mm	Air volume flow rate (m ³ /h ^{*4})		
			MM-DXC010	MM-DXC012	MM-DXV080	MM-DXV140	MM-DXV280	Cool *1	Heat *2	Min		Std	Max	Min
1.7	1		1			4.5	5	723	850	977	3.2 ~ 3.5	720	900	1080
2	1		1			5.6	6.3	850	1000	1150	3.2 ~ 3.5	720	900	1080
2.5	1		1			7.1	8	1063	1250	1438	3.5 ~ 4	1060	1320	1580
3	1		1			8	9	1275	1500	1725	3.5 ~ 4	1060	1320	1580
3.2	1		1			9	10	1360	1600	1840	3.5 ~ 4	1060	1320	1580
4	1			1		11.2	12.5	1700	2000	2300	4.5 ~ 5	1280	1600	1920
5	1			1		14	16	2125	2500	2875	5 ~ 5.5	1680	2100	2520
6	1			1		16	1	2550	3000	3450	5.5 ~ 6	1850	2800	3740
8	1				1	2.4	25	3400	4000	4600	6.5 ~ 7	2880	3600	4320
10	1				1	28	31.5	4250	5000	5250	7 ~ 8	3360	4200	5040
12	1	1		2		33.5	37.5	5100	6000	6900	DX-Coils > 10HP must be designed with multiple sections each 10HP, or less. These sections must have dedicated Headers and liquid capillary distributors. Therefore recommended orifice sizes only 2 - 10 HP	3700	5600	7480
14	1	1		1	1	10	45	5950	7000	8050		4730	6400	8060
16	1	1			2	45	50	6800	800	9200		5760	7200	8640
18	1	1			2	50.4	56	7650	9000	10350		6240	7800	9360
20	1	1			2	56	63	8500	10000	11500		6720	8400	10080
22	1	2		1	2	31.5	64	9350	11000	12650		7610	10000	12380
24	1	2			3	67	75	10200	12000	13800		8640	10800	12960
26	1	2			3	73.5	82.5	11050	13000	14950		9120	11400	13680
28	1	2			3	78.5	87.5	11900	14000	16100		9600	12000	14400
30	1	2			2	85	95	12750	15000	17250		10050	12600	15120
32	1	3			4	90	100	13600	16000	18400		11520	14400	17280
34	1	3			4	95.4	106.5	14450	17000	19550		12000	15000	18000
36	1	3			4	101	113	15300	18000	20700		12480	15600	18720
38	1	3			4	106.5	114	16150	19000	21850		12960	16200	19440
40	1	4			4	112	126	17000	20000	23000		13440	16800	20160
42	1	4			5	117.5	127	17850	21000	24150		14880	18600	22320
44	1	4			5	123	128	18700	22000	25300		15360	19200	23040
46	1	4			5	130	145	19550	23000	26450		15840	19800	23760
48	1	4			5	135	150	20400	24000	27600	16320	20400	24480	
50	1	4			5	140.4	156	21250	25000	28750	16800	21000	25200	
52	1	4			6	146	163	22100	26000	29900	18240	22800	27360	
54	1	5			6	151.5	164	22950	27000	31050	18720	23400	28080	
56	1	5			6	157	176	23800	28000	32200	19000	24000	28800	
58	1	5			6	162.5	177	24650	29000	33350	19680	24600	29520	
60	1	5			6	168	178	25500	30000	34500	20160	25200	30240	

*1 Cooling Capacity Conditions (Indoor 27 °Cdb / 19 °Cwb & Outdoor 35 °Cdb) at Standard Air Flow rate.
 *2 Heating Capacity Conditions (Indoor 20 °Cdb & Outdoor 7 °Cdb / 6 °Cdb) at Standard Air Flow rate.
 *3 SHRMe Capacity quoted as nominal cooling and maximum heating.
 *4 The standard Air volume flow rate is a guideline. The required capacity should determine DX-Interface size selection.

DX-Coils > 10HP must be designed with multiple pathways each 10HP or less. These pathways must have dedicated Headers and Liquid Capillary distributors. Therefore recommended sizes only needed for 2 - 10HP.

Single Port Flow Selectors (3-Series) MUST be used with the DX-Interface. It is not compatible with Multi Port Flow Selector (This limits the maximum SHRMe DX-Interface size to 42HP).

Heating & Cooling Capacity are guide-line figures, the design of each customer's AHU and DX Coil will have an impact on the actual system performance.
 Cooling Capacity Conditions (Indoor 27 °Cdb / 19 °Cwb & Outdoor 35 °Cdb) at Standard Air flow rate.
 Heating Capacity Conditions (Indoor 20 °Cdb & Outdoor 7 °Cdb / 6 °Cdb) at Standard Air flow rate.

MMW HOT WATER MODULE



With the mid temperature hot water module, produce hot water in addition of cooling and heating.

Hot water

- Designed to produce hot water from 25°C up to 50°C outlet water temperature, whilst still maintaining the performance and efficiency levels of the rest of the system.
- Compatible with both space heating and domestic hot water applications, making the unit particularly suited to small shops and residential apartments where both space heating and hot water production is required.

Adaptability

- Up to 200% diversity indoor units & hot water module
- Operating range from -20°C WB to 19°C WB.
- Compatible with 4 series FS box.

Installation

- Light and compact chassis to simplify the handling and the project integration.

CAPACITY



8kW > 16kW

HOT WATER



Max 50°C

SOUND PRESSURE LEVEL



25dB(A)

OUTDOOR UNITS



Mini SMMS-e
8/10HP



SMMS-u



SMMS-e
& SHRM-e

LOCAL CONTROLS



RBC-AMSU51E-ES/EN
RBC-AMTU31-E
RBC-ASCU11-E

HOT WATER MODULE Performance

Indoor unit	MMW-	UP0271LQ-E/TR	UP0561LQ-E/TR
Cooling capacity	kW	-	-
Heating capacity	kW	8	16
Power consumption	kW	0.014	0.014
Running current	A	0.08	0.08
Starting current	A	-	-

HOT WATER MODULE Physical data

Indoor unit	MMW-	UP0271LQ-E/TR	UP0561LQ-E/TR
Water flow	m³/h	1.374	2.748
Water flow	l/min	22.9	45.8
Sound pressure level	dB(A)	25	27
Dimensions (hwxwd)	mm	580x400x250	580x400x250
Weight	kg	17.8	20.3
Gas	in	5/8"	5/8"
Liquid	in	3/8"	3/8"
Drain port diameter	mm	R1	R1
Water Inlet	mm	R1 - 1/4"	R1 - 1/4"
Water Outlet	mm	R1 - 1/4"	R1 - 1/4"
Power supply	V-ph-Hz	220/240-1-50	220/240-1-50

MMW-AP_CHQ
HIGH TEMPERATURE HOT WATER MODULE



In addition to the standard simultaneous heating and cooling function of the SHRM-e system, it is now possible with the new Toshiba high temperature hot water module, to produce hot water up to 82°C, whilst still retaining the comfort operation of the indoor units.

High temperature

- Designed to produce hot water from 50°C up to 82°C outlet water temperature, whilst still maintaining the performance and efficiency levels of the rest of the system.
- Particularly suited for hot water sanitary production for residential and business applications.

All year round hot water

- All season hot water even when the other indoor units are operate in cooling.
- Operating range from -25°C WD to +40°C DB ambient condition.

CAPACITY



5HP

HOT WATER



82°C

OUTDOOR UNITS



SHRM-e

LOCAL CONTROLS



RBC-AMSU51E-ES/EN
RBC-AMTU31-E
RBC-ASCU11-E

HOT WATER MODULE Performance		PRELIMINARY DATA
Indoor unit	MMW-	AP0481CHQ-E
Cooling capacity	kW	-
Heating capacity	kW	14
Power consumption	kW	4.15
Running current	A	17.5
Starting current	A	-

HOT WATER MODULE Physical data		PRELIMINARY DATA
Indoor unit	MMW-	AP0481CHQ-E
Water flow	m³/h	2.400
Water flow	l/min	40
Sound pressure level	dB(A)	44
Dimensions (hxwx d)	mm	700x900x320
Weight	kg	100
Gas	in	5/8
Liquid	in	3/8
Drain port diameter	mm	15
Water Inlet	mm	R1 - 1/4"
Water Outlet	mm	R1 - 1/4"
Power supply	V-ph-Hz	220/240-1-50

ON YOUR OWN AS A FAMILY

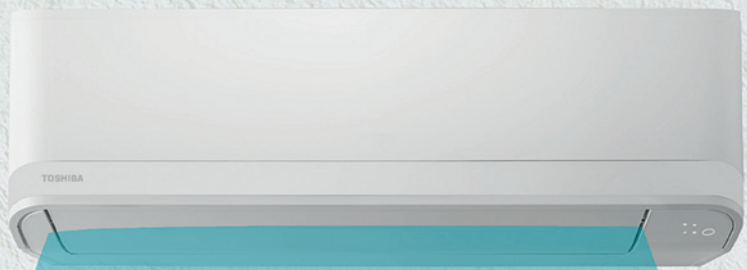

IN A GROUP ON



Take control of your comfort !

Toshiba offers various control solutions to meet users' and designers' expectations. From local individual control and settings to computer-based TCC link/TU2C link networks, all indoor units can be programmed and set to suit your operational needs. Remote control systems offer a wide range of features including schedule timers, diagnostic functions, power meters and input/output signals, to name just a few. Toshiba VRF units are compatible with industry standards and can be connected to all the main building management software systems in use. TCC link is Toshiba's dedicated Central Control Network which can be used with VRF and light commercial units either directly or by means of a specially-designed network adapter.



> CONTROLS

YOUR OWN AS A FAMILY IN A GROUP ON YOUR OWN



Toshiba Home
AC CONTROL

> DO YOU WANT A SMART SOLUTION TO GIVE YOUR FAMILY GREATER COMFORT WHILST EASILY MANAGING YOUR ENERGY SAVINGS?



- **MULTIPLE UNITS, ONE APP**
 - 1 user can control up to 10 AC units
 - 1 AC unit can be controlled by up to 5 users

- **EASY GROUPING**
 - Make control simple by grouping your AC units in up to 3 zones

- **SECURE CONNECTIONS**
 - Password & login
 - Child lock function

- **COMPATIBLE PRODUCTS**
 - DAISEIKAI 9, SHORAI, Console, SEIYA. (Jan'19)

- **DOWNLOAD YOUR APP**
 - Toshiba AC Control App for your Android and iOS smartphone from Google Play or the App Store



Take complete control of your comfort with the Toshiba Home AC Control App. Simple to use on your smartphone or tablet, both at home and on the move. Fully compatible, the adapter can be used with all Toshiba High-walls and Console units.

Enhance your comfort, at home or away

Customise your comfort, finding the perfect cooling or heating level for your family at any time, no matter where you are. When at home, simply replace your infrared remote control with the intuitive smart app. This also gives you easy access to your air conditioner on the move, allowing you to adapt your comfort to your lifestyle!



Smart & efficient

- Want to go home and immediately enjoy an ideal temperature? Simply use the app to check the status, quickly and easily, adjust your comfort, no matter where you are.
- Match your AC schedule to your family's routine to optimise running time, and enjoy savings on your energy bill.

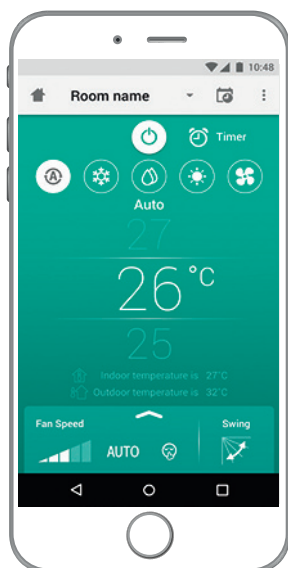

Modern app

- This user-friendly app is available in 5 languages, and boasts a host of intuitive features. With a different colour for each different mode, and the main functions accessible in just one touch.
- Toshiba premium features enable you to enjoy all the benefits of your AC systems at home. Simply swipe up on the main app screen on your smartphone or tablet to access additional Toshiba-specific features.

FLOOR

- 8°C** Holiday frost protection mode
- Hi POWER** Boost mode
- FIREPLACE** Fireplace mode
- Silent** Silent CDU to reduce the outdoor unit noise level
- PURE** Plasma & ionizer filters
- FLOOR** Floor function for Consoles

> CONTROLS

Toshiba
AC CONTROL

> “DO YOU WANT FULL CONTROL OF YOUR AC SYSTEM IN ONE TOUCH, WHEREVER YOU ARE?”

Designed for commercial applications, the Toshiba AC Control App is your one-stop solution for managing up to 32 indoor units via an Android or iOS smartphone, with all main functions accessible in a single touch.

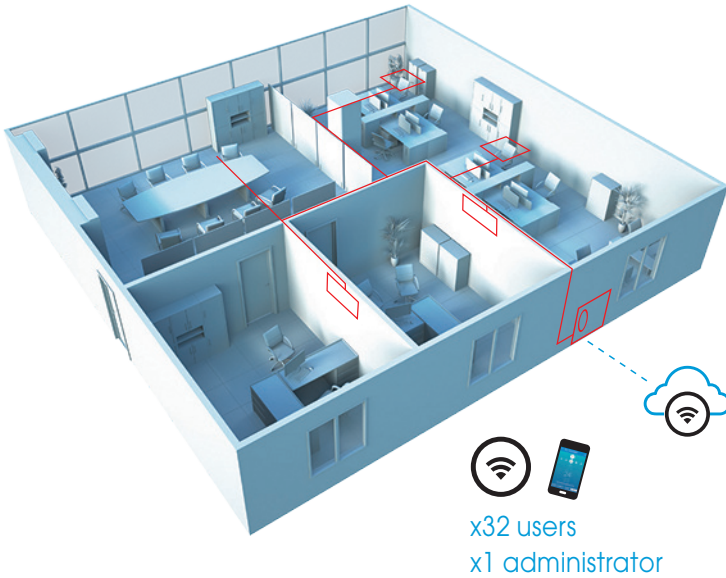

x32 users
x1 administrator



BMS-IWF0320E

Solutions wherever you are

Toshiba technology you can trust, fully committed to providing creative building management solutions, designed to enhance your sustainable lifestyle.

Make it your own

With different access levels for different users, this app can be used by everyone from facilities managers to standard users to manage all of the unit's functions. For an enhanced level of security, a user name and password is needed to log in.

Everything you need in one app

All of the indoor unit's functions can be accessed in an instant, allowing you to enjoy the full advantages of the AC system at work. The entire system is simple to manage, even remotely.

● **QUICK AND EASY**

- Simplified installation with direct connection to the TCC link bus line

● **DESIGNED FOR YOU**

- Up to 32 users for control of a maximum of 32 assigned indoor units
- Administrator mode for control of the entire system via a single app

● **EVERYTHING UNDER CONTROL**

- Optimise the management of your facilities without compromising comfort

● **COMPATIBLE PRODUCTS**

- Mini SMMS-e, SMMS-e, SHRM-e and RAV systems

● **DOWNLOAD YOUR APP**

- Toshiba AC Control App for your Android and iOS smartphone from Google Play or the App Store



Mode (heating, cooling, ventilation, dry, auto)

Temperature set point, ambient temperature information

Fan speed (auto or manual)



On/Off

Louver setting (auto or manual)

Administrator-specific functions:

- Group control with on/off function for all devices
- User access restriction management & advanced mode

RAV/VRF
INDIVIDUAL REMOTE CONTROLLER

> **INFRARED REMOTE CONTROLLER**

One remote compatible with every LC/VRF indoor units



Included with bi-flow console



Included with LC/VRF highwall



RBC-AX41U(W)-E

- Panel corner receiver (compatible with 4-Way smart cassette)



RBC-AXU31U-E

- Panel corner receiver (compatible with standard 4-Way cassettes)



RBC-AX33UYP-E

- Panel corner receiver (compatible with YHP 1-way cassette)



RBC-AXU31UM-E

- Panel corner receiver (compatible with compact 4-Way cassette)

- Easy to use remote controller with direct access to every function
- In addition of standard function, HI power, Quiet and Comfort sleep mode
- 2 steps timer mode



RBC-AX31UC-E

- Front panel receiver (compatible with ceiling and 1-Way cassette units)



RBC-AXU31-E

- Stand alone receiver (compatible with all indoor units)

> **WIRED REMOTE CONTROLLER**

One solution for every projects



RBC-ASCU11-E

Back to basics with this new remote offering all the standard functionalities with compact dimensions and large screen.

Functions:

On/Off, operation mode, temperature setting, fan speed, louvres fault codes & unit setup.



RBC-AMTU31-E

The standard remote to control an individual indoor unit or a group of 8 indoor units

Functions:

On/Off, operation mode, temperature setting, fan speed, louvres, fault codes, unit setup and button restrictions



RBC-AMSU51E-ES/EN

The ultimate in local remote controller with built-in 7-Day timer, large screen and menu

Functions:

On/Off, operation mode, dual set point, fan speed, louvres, return back, energy savings, frost protection, auto summer/winter clock, soft cooling, leak detection, fault codes, unit setup and button restrictions

> **SPECIFIC REMOTE CONTROLLER**

Ventilation control



NRC-01HE

- Dedicated remote controller for Air-to-Air heat exchanger
- Integrated functions: fan speed, freecooling, air balance volume rate, temperature management and timer

RAV/VRF
CENTRAL CONTROL

> UP TO 64 INDOOR UNITS

64 central controller



TCB-SC640U-E

- Full control of max 64 indoor units
- Individual indoor unit, group (up to 10 groups) or full installation control
- Simple and intuitive interface with user friendly menus
- Large bbacklight display
- Touch-sensitive keys
- Standard features (On/Off, mode, temperature setting, fan speed, louvers)
- + permit/prohibit functions
- Embedded digital outputs
- Compatible with TCC link and TU2C Link

Centralized Touch Screen Controller



TCB-TSC640-PY

- Centralized control of max 64 indoor units
- 7-inch color touch screen
- User friendly interface (indoor unit and room naming)
- One by one FCU or global system control: On/Off, mode, fan speed, louvers, set point and prohibit mode
- Daily, weekly, monthly and annually timer with Winter/Summer differentiation: up to 32 schedules
- Fault code acces
- Multilangage interface
- Compatible with TCC link

> UP TO 128 INDOOR UNITS

Smart Manager



BMS-SM1281ETLE

The Smart Manager has the same hardware control function as the Compliant Manager, but also has the ability of control from a Local Area Network with dedicated interface accessible from every Web Browser. Energy Monitoring and Data Analyser function is included and brings to the user strong tool to analyse power consumption day by day, hour by hour and finally save energy. Compatible with TCC link

This controller is ideal where advanced control, Energy Monitoring, advanced scheduling or acces to individual Air Conditioners is required from networked computer systems

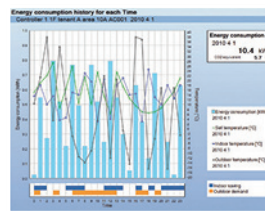

Energy consumption history

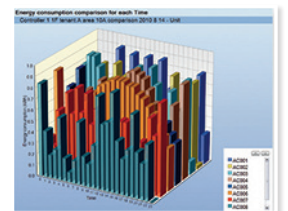

Energy consumption comparison

RAV/VRF
CENTRAL CONTROL

> UP TO 256 INDOOR UNITS

Touch Screen Smart Manager

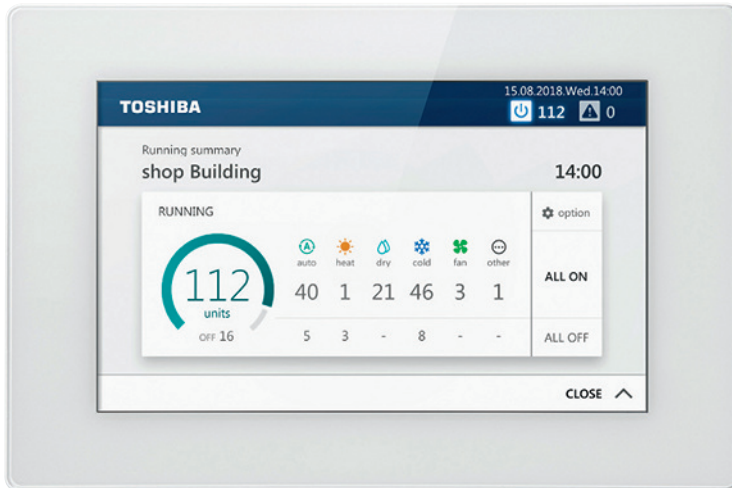

BMS-CT2560U-E



- Full control of max 256 indoor units
- 7" color touchscreen
- Nice looking menu with intuitive navigation to enhance control experience
- Advanced scheduling of indoor and outdoor units to maximize comfort & save energy
- Energy monitoring with or without power meter thanks to Data Analyser software
- Webserver to keep control in any circumstances
- Embedded input and output to enlarge control or interact with other equipment
- Dedicated fault code menu with Email transfer capability
- Compatible with TCC link & TU2C link



> UP TO 512 INDOOR UNITS

Centralized Touch Screen Controller



BMS-CT5121E

- Full control of max 512 indoor units: on/off, mode, set point, fan speed, louver management and prohibit mode
- 12.1 large screens
- Quick and accurate view of indoor unit status through dedicated logo
- Floor, building, tenant and system overview with possibility to integrate plan
- Built in web server for control through web browser
- Weekly timer with up to 20 steps per day
- Energy monitoring with graph, to view operating hours, set point, inside/outside temperature, and power consumption
- Email alert in case of troubles
- Compatible with TCC link



VRF LEAK DETECTION

The complete answer to EN378 standard leak detection requirements

> **Solution 1:**

Audible and visual alarm when leak is detected

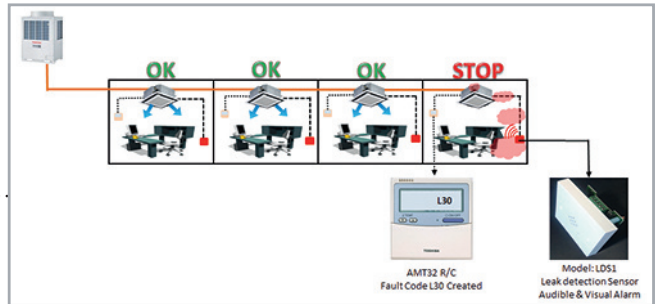

> **Solution 2:**

Audible and visual alarm + Concerned indoor unit insulation when leak is detected

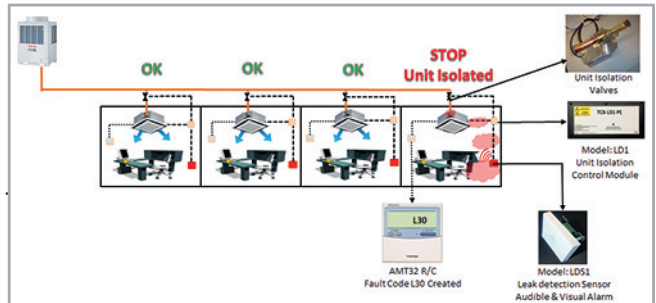

> **Solution 3:**

Audible and visual alarm + Refrigerant pump down when leak is detected (SMMS-e and SHRM-e only)

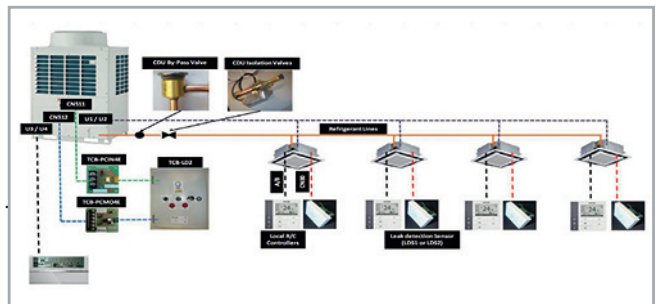

> LEAK DETECTION SENSOR



TCB-LDS1 (plastic)
TCB-LDS2 (metal)

- Refrigerant leak detection and alarm module via audible and visual indicator. Available in plastic or steel finishing.

> CONTROL MODULE



TCB-LD1 (insulation)
TCB-LD2 (pump down)

- Control module to activate insulation and pump down.

> ISOLATION VALVE



TCB-AW17861 to TCB-AW17867

- Isolates refrigerant line between CDU and indoor pipework (pipe diameter size from 12.7 to 22.2mm).

> ACCESSORIES

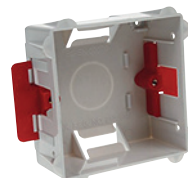

TCB-LDSBB1 (dry lining)
TCB-LDSBB2 (concrete)

- Flush mounting for LDS1 or LDS2 sensors

> Additional
PCB

> DEDICATED FOR OUTDOOR UNITS
Outdoor units advanced functions

> POWER PEAK CUT CONTROL BOARD SENSOR



TCB-PCDM4E

- Limit capacity of the VRF outdoor unit at 85%, 80%, 75% and 60% load or stop it.
- Compatible with all VRF outdoor unit.

> CONTROL OPERATION BOARD SENSOR



TCB-PCIN4E

- Error/Individual compressor operation output control board.
- Compatible with all VRF outdoor units.

> EXTERNAL MASTER ON/OFF CONTROL SENSOR

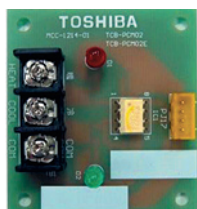

TCB-PCMO4E

- External master On/Off control board, night mode and mode priority selection.
- Compatible with all VRF outdoor units.

> APPLICATION CONTROL SENSOR KIT



TCB-PCOS1E2

- Enables night operation control, demand control and operation monitoring.
- Compatible with DI.

> DEDICATED FOR INDOOR UNITS

Indoor units advanced functions

> WINDOWS SWITCH SENSOR

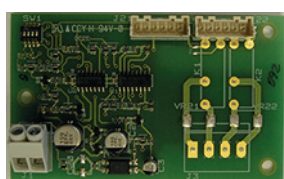

TCB-IFCB5PE

- Ensures the indoor unit not operate when outside window is open or for Door Entry systems.
- RAS, RAV and VRF indoor units.

> OPTIONAL CONNECTION KIT



TCB-PCUC2E

- Extends control capability of light commercial and VRF indoor units with third party equipment.
- Compatible with RAV and VRF indoor units.

> MULTI-TENANT



TCB-PSMT1E

- For multi tenant application, this PCB maintains low voltage power supply during Tenant Absence when the main power supply for the FCU is shut down.
- Compatible with VRF indoor units.

> TCC LINK INTERFACE



TCB-PCNT30TLE2

- Allows DI/SDI indoor units & AHU DX kits to be connected to TCC link network.

> RAV/VRF/ESTIA GATEWAY

> MODBUS® RTU

Reliable and easy to use



TCB-IFMB641TLE

Directly connects up to 64 Toshiba Air Conditioning indoor units and up to 16 outdoor units to a Modbus® Building Management System. Maximum 15 Modbus I/F can be connected per Modbus Master Device.

Individual gateway



BMS-IFMB0TLR-E (RAV/VRF)
BMS-IFMB0AWR-E (Estia)

Connect easily one indoor unit or a group of 8 indoor units to a Modbus Building Management Control System.

> LONWORKS®

12 input network variables



TCB-IFLN642TLE

Directly connect up to 64 Toshiba Air Conditioning indoor units and up to 16 outdoor units to a Lonworks® Building Management Control System. Compatible with RBC-WP1-PE Lonworks Control software.

> KNX®

ETS configuration



TO-AC-KNX-64 (RAV/VRF)
TO-AC-KNX-16 (RAV/VRF)
BMS-IFKX0TLR-E (RAV/VRF)
BMS-IFKX0AWR-E (Estia)

Directly connect up to 64, 16 or only one Toshiba Air Conditioning indoor units to a KNX® Building Management Control System.

> BACNET® IP

Standard gateway



BMS-IFBN640TLE

Directly connect up to 64 Toshiba Air Conditioning indoor units to a BACnet® Building management Control System.

Network adaptor TCB-PCNT30TLE2
required for connection of DI/SDI
Indoor Units (1 per Master Indoor Unit)

> RAV/VRF INTERFACES

> ANALOGUE INTERFACE

Analogue 0/10V control



TCB-IFCB640TLE

The Analogue Relay Interface is a device that can be connected directly to the TCC-Link Central Control network to provide Analogue & Digital Inputs & Outputs for control over Toshiba Air Conditioner products from non-Toshiba control systems.

> GENERAL PURPOSE RELAY INTERFACE

Toshiba equipment control



TCB-IFCG1TLE

The General Purpose Relay Interface is a device that can be connected directly to the TCC-Link Central Control Network and addressed on the TCC-Link Network in order to provide control of non-Toshiba equipment from a Toshiba control system, and control of the Toshiba Air Conditioner from Digital & Analogue Inputs.

> GSM INTERFACE

Control any time anywhere...



TCB-IFGSM1E

The TCB-IFGSM1E Interface is a device that allows control of the Toshiba Air Conditioning Equipment from a remote location using standard GSM (Global system for Mobile communications) Mobile phone SMS text messages.



Model number	Reference	TCC link	TU2C link	Description	Used with
BMS-CT2560U-E	Touch Screen Smart Manager	●	●	Enables full control of up to 256 indoor units with energy monitoring and advanced control options	network 1:1 model connection interface required for DI/SDI (Excluding high-wall type)
BMS-CT5121E	Touch Screen controller	●		Enables full control of up to 512 indoor units with electric billing, ML	network 1:1 model connection interface required for DI/SDI (Excluding high-wall type)
BMS-IFBN640TLE	BN Interface	●		BACnet Interface for LC & VRF	Enables integration with BACnet
BMS-IFDD03E	Digital I/O relay interface	●		Digital I/O relay interface	Touch screen controller, Compliant manager, Web based controller, Smart Manager
BMS-IFX0TLR-E	1:1 KNX interface	●		Connect the system to a KNX Building Management System	VRF, DI,SDI indoor units by using Remote Control wiring
BMS-IFLSV4E	TCS-Net relay interface	●		Relay for integration to TCS-Net	Bacnet gateway, Touch-screens & Web based controller
BMS-IFMB0TLR-E	1:1 Modbus interface	●		Connect the system to a Modbus Building Management System	VRF, DI,SDI indoor units by using Remote Control wiring
BMS-IFWH5E	Energy monitoring relay interface	●		Energy monitoring relay interface	Touch screen controller, Compliant manager, Web based controller, Smart Manager
BMS-IWF0320E	Smart Device control interface	●		Enables full control of up to 32 indoor units by Smart device with Toshiba AC app (Local Smart phone & Tablet)	VRF, DI,SDI indoor units
BMS-SM1281ETLE	Smart Manager with data analyser	●		Enables full control of up to 128 indoor units with energy monitoring and advanced control options.	network 1:1 model connection interface required for DI/SDI (Excluding high-wall type)
HWS-AMS11E	Room temperature remote controller	●		Wired Estia room temperature remote controller including schedule timer	Estia
NRB-1HE	Remote ON/OFF adapter	●		Allows ON/OFF control	All Air-to-air heat exchangers
NRC-01HE	Wired remote controller	●		Air-to-air heat exchanger remote controller, including with DX coil and humidifiers models	Air-to-air heat exchangers and Air-to-air heat exchangers with DX coil
RBC-AMSU51E-EN/ES	Design remote controller with schedule timer	●	●	Multi-Language LCD display, a built-in 7-Day timer, Energy Saving options and return back function, Dual set points, and Soft cooling. EN = English, Italian, Polish, Greek, Russian, Turkish. ES = English, Spanish, Portuguese, French, Dutch, German	VRF, DI,SDI indoor units (except VRF Air-to-air heat exchangers with DX coil)
RBC-AMTU31-E	Wired remote controller	●	●	Main wired remote controller	VRF, DI,SDI indoor units (except VRF Air-to-air heat exchangers with DX coil)
RBC-ASCU11-E	Simplified wired remote controller	●	●	Nice looking and easy to use simplified remote controller for all type of applications	VRF, DI,SDI indoor units (except VRF Air-to-air heat exchangers with DX coil)
RBC-AX33UYP-E	Wireless remote unit kit	●	●	Wireless remote unit kit for 1-way cassette	YHP 1-way cassette & RBC-UY32P-E panel
RBC-AXU31C-E	Infra-red remote kit	●	●	Wireless remote controller	All ceiling units and one-way cassettes (SH series)
RBC-AXU31-E	Infra-red remote kit	●	●	Wireless remote controller	All other units
RBC-AXU31U-E	Wireless remote unit kit	●	●	Wireless remote unit kit for 4-way cassette	4 way cassette & RBC-U31PG(W)-E, PGP(W)-E, PGPS(W)-E panels
RBC-AXU31UM-E	Wireless remote unit kit	●	●	Wireless remote unit kit for 4-way compact cassette	4 way compact cassette & RBC-UM21PG(W)-E panel
RBC-AXU31W-E	Wireless remote unit kit	●	●	Wireless remote unit kit for 2-way cassette	
RB-RWS20-E	Wired remote controller				Duct unit (RAS-MxxG3DV-E) for IMS
RB-RXS30-E	Wireless controller with a weekly timer program			Wireless controller with a weekly timer program	RAS Single Split
RB-RXS31-E	Wireless controller with a weekly timer program			Wireless controller with a weekly timer program	RAS Multi Split (IMS)
TCB-IFCB4E2	Remote location On/Off control box			Enables remote location On/Off control	All indoor units
TCB-IFCB5-PE	Window switch & remote on/off			Ensure the indoor unit not operate when outside window is open or for door entry systems	RAS, RAV & VRF (RAS units must have HA connection and is not compatible with GDV duct)
TCB-IFCB640TLE	Analog interface	●		Control & monitoring up to 64 indoor units on TCC-link	Combination with TCB-IFCG1TLE
TCB-IFCG1TLE	General purpose interface	●		Enables control of A/C by the DI/DO and AI/AO	DI, SDI. Combination with TCB-IFCB640TLE
TCB-IFGSM1E	GSM control interface	●		Allows ON/OFF control, operation status monitoring & alarm monitoring of A/C	DI, SDI (using CN61)
TCB-IFLN642TLE	LN interface	●		Allows control of 64 indoor units from a Lonworks based BMS	network 1:1 model connection interface required for DI/SDI (Excluding high-wall type)
TCB-IFMB641TLE	Modbus interface box	●		Connect the system to a Modbus Building Management System	network 1:1 model connection interface required for DI/SDI (Excluding high-wall type)
TCB-KBCN32VEE	Connectors			For CN32	VRF,DI, SDI
TCB-KBCN60OPE	Connectors			For CN60	VRF,DI, SDI
TCB-KBCN61HAE	Connectors			For CN61	VRF,DI, SDI
TCB-KBCN70OAE	Connectors			For CN70	VRF,DI, SDI
TCB-KBCN73DEE	Connectors			For CN73	VRF,DI, SDI
TCB-KBCN80EXE	Connectors			For CN80	VRF,DI, SDI
TCB-KBOS4E	Optional connector kit			Connector kit	SDI outdoor units (Except for SDI (RAV-SP404/454/564AT-E))
TCB-PCDM4E	Application control PC Board			Power peak cut control	SMMS-e, SHRM-e and Mini-SMMS Outdoor Units
TCB-PCIN3E	Output signal PC Board			Boiler operation, alarm, defrost and compressor operation output signal	Estia
TCB-PCIN4E	Application control PC Board			Error/Individual compressor operation output control board	SMMS-e, SHRM-e and Mini-SMMS Outdoor Units
TCB-PCMO3E	Input signal PC Board			Room thermostat, emergency stop input signal	Estia
TCB-PCMO4E	Application control PC Board			External master ON/OFF control board	SMMS-e, SHRM-e and Mini-SMMS Outdoor Units
TCB-PCNT30TLE2	1:1 model connection interface			Integration with DI, SDI, AHU DX Kits	Allows DI/SDI indoor units& AHU DX kits to be connected toTCC link network
TCB-PCUC2E	Optional connecting kit			Enables control of A/C by the DI/DO	VRF and LC indoor units
TCB-PSMT1E	Optional connector kit			Multi-tenant kit for VRF systems	SMMS-e, SHRM-e and Mini-SMMS Indoor Units (refer to I/M for more details of connectable Indoor units)
TCB-PX100-PE	Enclosure for the window switch			For use when the window switch / remote On/Off accessory cannot fit within the AC unit, eg. High Walls	For use with TCB-IFCB5-PE and TCB-PCNT30TLE2
TCB-PX30MUE	E-Box extension enclosure			For 1:1 Model connection I/F and window switch / remote On/Off PCB	4-Way Cassettes only & TCB-PCNT30TLE2 & TCB-IFCB5-PE
TCB-PX40MUE	E-Box extension enclosure			For 1:1 Model connection I/F and window switch / remote On/Off PCB	4-Way Compact Cassettes only & TCB-PCNT30TLE2 & TCB-IFCB5-PE
TCB-SC640U-E	Centralized remote controller	●	●	Enable full control of up to 64 indoor units. Embedded I/O signal availables	VRF systems
TCB-TC41U-E	Remote temperature sensor	●	●	Remote temperature sensor for cassette & duct	DI, SDI, VRF Indoor units

> LIGHT COMMERCIAL ACCESSORIES

Indoor unit type	Parts name	Model name	Comply with RAV FCU	Notes	Remarks	
Smart 4-way Air Discharge cassette type	Standard panel	RBC-U41PG(W)-E	RAV-GM***UT-E	Required accessory		
	Motion Sensor	TCB-SIR41U-E				
	Fresh air and filter chamber	TCB-GFC1603UE			For fresh air inlet box	
	Fresh air inlet box	TCB-GB1602UE		For fresh air intake by using the knockout hole of Fresh air and filter chamber. (dia.=100 mm)	Use with TCB-GFC1603UE	
	Auxiliary fresh air flange	TCB-FF101URE2		For easy fresh air intake by using the knockout hole of indoor unit. (dia.=100mm)		
	Spacer for height adjustment	TCB-SP1603UE		height 50 mm		
4-way Air Discharge cassette type	Standard panel	RBC-U31PGP(W)-E	RAV-RM***UTP-E	Required accessory		
	MTO straight, white color panel	RBC-U31PGSP(W)-E				
	Fresh air and filter chamber	TCB-GFC1602UE			For fresh air inlet box	
	Fresh air inlet box	TCB-GB1602UE		For fresh air intake by using the knockout hole of Fresh air and filter chamber. (dia.=100 mm)	Use with TCB-GFC1602UE	
	Auxiliary fresh air flange	TCB-FF101URE2		For easy fresh air intake by using the knockout hole of indoor unit. (dia.=100mm)		
	Spacer for height adjustment	TCB-SP1602UE		height 50 mm		
Compact 4-way cassette type	Standard panel	RBC-UM21PG(W)-E	RAV-RM***MUT-E	Required accessory		
	Motion Sensor	TCB-SIR41UM-E			Wireless remote controller kit (RBC-AX32UM(W)-E) and Occupancy sensor cannot be used on the same indoor unit.	
Slim duct type	Auxiliary fresh air flange	TCB-FF101URE2	RAV-RM***SDT-E	For easy fresh air intake by using the knockout hole of indoor unit. (dia.=100mm)		
Concealed duct type	Spigot shaped flange	TCB-SF56C6BE	RAV-RM4018TP-E, RAV-SM456BTP-E & RAV-RM5618TP-E			
		TCB-SF80C6BE	RAV-RM8018TP-E			
		TCB-SF160C6BE	RAV-RM1**18TP-E			
Ceiling-suspended type	Drain pump kit	TCB-DP31CE	RAV-RM***1CTP-E	Lift up to 600 mm	Use TCB-KP13, 23CE	
	Elbow Piping Kit	TCB-KP13CE TCB-KP23CE	RAV-RM401CTP-E & RAV-RM501CTP-E RAV-RM801CTP-E & RAV-RM1**1CTP-E	Needed when drain pump kit is used		
Concealed Duct high static pressure type	Long life filter kit	TCB-LK2801DP-E	RAV-RM***DTP-E			
	Drain Pump kit	TCB-DP40DPE				

Code	Description	Capacities
RBC-TWP30E2	Twin-branch kit for DI & SDI	1.5 HP + 1.5 HP 2 HP + 2 HP
RBC-TWP50E2	Twin-branch kit for DI & SDI	3 HP + 3 HP 4 HP + 4 HP
RBC-TWP101E	Twin-branch kit for BigDI	5 HP + 5 HP
RBC-TRP100E	Triple-branch kit for DI & Big DI	2 HP + 2 HP + 2 HP 3 HP + 3 HP + 3 HP
		2 HP + 2 HP + 2 HP + 2HP 3 HP + 3 HP + 3 HP + 3HP
RBC-DTWP101E	Double-twin branch kit fir Big DI	2 HP + 2 HP + 2 HP + 2HP 3 HP + 3 HP + 3 HP + 3HP

> BUSINESS REFRIGERANT ACCESSORIES

Model Name	Specification	Total capacity codes	To be used with	
RBM-BY55E	Branching joint	< 6.4 HP	MINI-SMMS, MINI-SMMS-e, SMMS-e & SMMS-u	
RBM-BY105E		< 6.4 - 14.2 HP		
RBM-BY205E		< 14.2 - 25.2 HP		
RBM-BY305E		< 25.2 HP - 61.2 HP		
RBM-BY405E		61.2 HP		
RBM-BY55FE	Branching joint	< 6.4HP	SHRM-e	
RBM-BY105FE		< 6.4 - 14.2 HP		
RBM-BY205FE		< 14.2 - 25.2 HP		
RBM-BY305FE		25.2 HP		
RBM-HY1043E		Headers branching four-way		< 14.2 HP
RBM-HY2043E	Headers branching eight-way	< 14.2 - 25.2 HP		
RBM-HY1083E	Headers branching eight-way	< 14.2 HP		
RBM-HY2083E	Headers branching four-way	< 14.2 - 25.2 HP		
RBM-HY1043FE	Headers branching four-way	< 14.2 HP	SHRM-e	
RBM-HY2043FE	Headers branching eight-way	< 14.2 - 25.2 HP		
RBM-HY1083FE	Headers branching eight-way	< 14.2 HP		
RBM-HY2083FE	Flow selector unit	< 4.0 HP indoor units		SHRM-e
RBM-Y1123FE	Flow selector unit	< 4.0 - 6.4 HP indoor units		
RBM-Y1803FE	Flow selector unit long piping	< 6.4 - 10.0 HP indoor units		
RBM-Y1124FE	Flow selector unit long piping	< 4.0 HP indoor units		
RBM-Y1804FE	Flow selector unit long piping	< 4.0 - 6.4 HP indoor units		
RBM-Y2804FE	Multi-port flow selector unit	< 6.4 - 10.0 HP indoor units	SHRM-e	
RBM-Y1801F4PE		< 6.4 HP indoor units x 4 port		
RBM-Y1801F6PE	Multi-port flow selector unit	< 6.4 HP indoor units x 6 port	SHRM-e	
RBM-BT14E	Joints for connection of outdoor units	< 26 HP system capacity	SMMS-e, SMMS-u	
RBM-BT24E		> 26 < 46 HP system capacity		
RBM-BT34E		> 46 HP system capacity	SMMS-u	
RBM-BT14FE		< 26 HP system capacity	SHRM-e	
RBM-BT24FE		> 26 HP system capacity		

> VRF ACCESSORIES

Indoor unit type	Parts name	Model name	Comply with VRF FCU	Notes	Remarks
4-way Air Discharge cassette type	Standard panel	RBC-U31PGP(W)-E			
	MTO straight, white color panel	RBC-U31PGSP(W)-E		Required accessory	
	Fresh air and filter chamber	TCB-GFC1602UE		For fresh air inlet box	
	Fresh air inlet box	TCB-GB1602UE	MMU-UP***HP-E	For fresh air intake by using the knockout hole of Fresh air and filter chamber. (dia.=100 mm)	Use with TCB-GFC1602UE
	Auxiliary fresh air flange	TCB-FF101URE2		For easy fresh air intake by using the knockout hole of indoor unit. (dia.=100mm)	
	Spacer for height adjustment	TCB-SP1602UE		height 50 mm	
Compact 4-way cassette type	Air discharge direction kit	TCB-BC1602UE		Air direction change by cutting off air discharge port (3 pcs.)	
	Decoration panel	RBC-UM11PG(W)E RBC-UM21PG(W)-E	MMU-UP***MH-E	Required accessory Required accessory	Wireless remote controller kit (RBC-AX32UM(W)-E) and Occupancy sensor cannot be used on the same indoor unit.
2-way cassette type	Motion Sensor	TCB-SIR41UM-E			
	Decoration panel	RBC-UW283PG(W)-E RBC-UW803PG(W)-E RBC-UW1403PG(W)-E	MMU-UP0071/0091/0121/0151WH-E MMU-UP0181/0241/0271/0301WH-E MMU-UP0361/0484/0561WH-E	Required accessory	
	Auxiliary fresh air flange	TCB-FF151US-E	MMU-UP***1WH-E	For easy fresh air intake by using the knockout hole of indoor unit	
	Filter chamber	TCB-FC283UW-E TCB-FC803UW-E TCB-FC1403UW-E	MMU-UP0071/0091/0121/0151WH-E MMU-UP0181/0241/0271/0301WH-E MMU-UP0361/0484/0561WH-E		
	Super Long life filter	TCB-LF283UW-E TCB-LF803UW-E TCB-LF1403UW-E	MMU-UP0071/0091/0121/0151WH-E MMU-UP0181/0241/0271/0301WH-E MMU-UP0361/0484/0561WH-E	For use with filter chamber	Use with TCB-FC283UW-E Use with TCB-FC803UW-E Use with TCB-LF1403UW-E
	1-way cassette type	Air purifier kit	TCB-EAPC1UYHP-E		
Motion Sensor		TCB-SIR41UY-P-E	MMU-UP***YHP-E		
Decoration panel		RBC-UY32P-E RBC-US21PGE		Required accessory	
Front air discharge unit		TCB-BUS21WHE	MMU-UP***SH-E		
Slim duct type	Auxiliary fresh air flange	TCB-FF101URE2	MMU-UP***SPHY-E	For easy fresh air intake by using the knockout hole of indoor unit. (dia.=100mm)	
Concealed duct type	Spigot shaped flange	TCB-SF56C6BE TCB-SF80C6BE TCB-SF160C6BE	MMD-UP0051/0071/0091/0121/0151/0181BHP-E MMD-UP0241/0271/0301BHP-E MMD-UP0361/0481/0561BHP-E		
	Long life filter kit	TCB-LK801D-E TCB-LK1401D-E TCB-LK2801DP-E	MMD-UP0181/0241/0271HP-E MMD-UP0361/0461/0561HP-E MMD-UP0721/0961HP-E		
	Spigot shaped flange	TCB-SF80C6BE TCB-SF160C6BE	MMD-UP0181/0241/0271HP-E MMD-UP0361/0461/0561HP-E		
Concealed Duct high static pressure type	Auxiliary fresh air flange	TCB-FF151US-E	MMD-UP***1HP-E		
	Drain Pump kit	TCB-DP40DPE	MMD-UP***1HP-E		
High Wall without PMV	PMV Kit	RBM-PMV0361U-E RBM-PMV0901U-E		For FCU capacity 0.3-1.3HP For FCU capacity 1.7-2.5HP	
	High efficiency filter 65	TCB-UFM0481D-E TCB-UFM1281D-E	MMD-UP0481HFP-E MMD-UP0721HFP-E - MMD-UP1281HFP-E	Dust collecting effect: 65% (NBS Colorimetric method)	Use with TCB-PF4D-1E Use with TCB-PF3D
Fresh air intake type	High efficiency filter 90	TCB-UFH0481D-E TCB-UFH1281D-E	MMD-UP0481HFP-E MMD-UP0721HFP-E - MMD-UP1281HFP-E	Dust collecting effect: 90% (NBS Colorimetric method)	Use with TCB-PF4D-1E Use with TCB-PF3D
	Long life filter (stand-alone)	TCB-LK1401D-E TCB-LK1281DP-E	MMD-UP0481HFP-E MMD-UP0721HFP-E - MMD-UP1281HFP-E		Use with TCB-FCY51DFE Use with TCB-PF3D
	With high efficiency filter	TCB-LK1401D-E TCB-PF1281D-E	MMD-UP0481HFP-E MMD-UP0721HFP-E - MMD-UP1281HFP-E		High efficiency filter requires filter chamber and can be used with Long Life Filter
	Filter chamber	TCB-FC0481DF-E TCB-FC1281DF-E	MMD-UP0481HFP-E MMD-UP0721HFP-E - MMD-UP1281HFP-E	For high efficiency filter or long life prefilter	
	Drain pump kit	TCB-DP40DFP-E	MMD-UP0721HFP-E - MMD-UP1281HFP-E	Lift up to 330 mm	
	Air-to-air heat exchanger with DX coil	Drain pump kit	TCB-DP31HEXE	MMD-VN502/802/1002HEXE & MMD-VNK502/802/1002HEXE	Lift up to 330 mm
Ceiling-suspended type	Drain pump kit	TCB-DP31CE	MMC-UP***1HP-E		Use TCB-KP*4CPE
	Elbow Piping Kit	TCB-KP14CPE TCB-KP24CPE	MMC-UP0151/0181HP-E MMC-UP0241/0481HP-E	Needed when drain pump kit is used	

SOFTWARE

SELECTION TOOL



Toshiba Selection software has been fully designed, with a user-friendly interface allowing novice and expert users alike to create simple, yet detailed VRF system schematics. It is highly versatile, allowing the level of detail to be tailored to suit customer requirements. The software also allows the user to specify pricing strategy and create additional interim reports, including any diagrams and schematics required. Final detailed reports can then be produced and sent to customers in PDF format or in more complex files, such as AutoCAD DXF, allowing simple integration into their existing software packages.

Software main screen

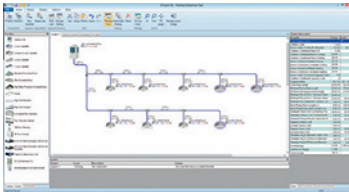

Project fully customizable

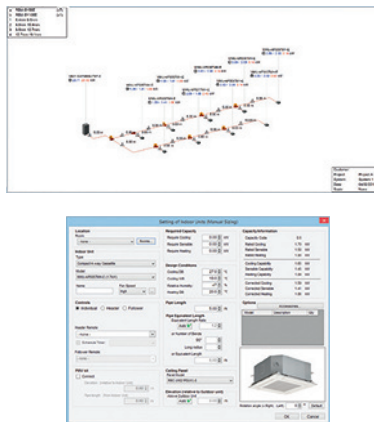

Complete report

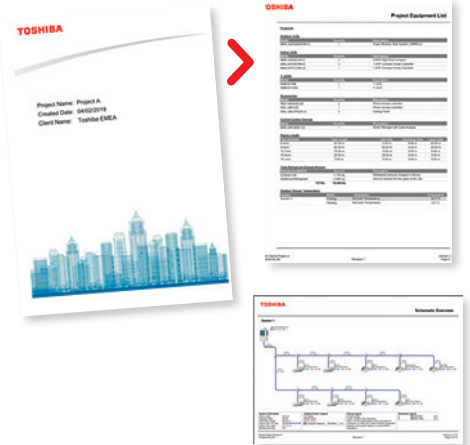

SERVICE TOOL

Save time during commissioning and maintenance. Choose between the "Wave Tool Advance" using Smartphone NFC connection or the link adaptor connected to the outdoor or indoor unit.

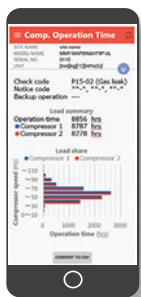
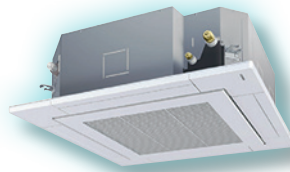

Wireless connection using smartphone* NFC technology to collect system data

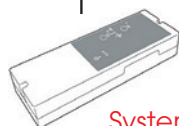

System operation self record using link adaptor

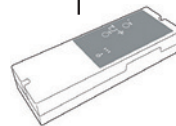

Get access to system data indoor using link adaptor



Direct USB connection to get access to system data

* Please contact Toshiba for Android® phone compatibility list.

Wave tool compatible with SMMS-u, SMMS-e and SHRM-e. Service tool compatible with SMMS-u only. Please, use Dyna Doctor for MINI SMMS-e, SMMS-e & SHRM-e.

> INSTALLATION AND USE OF REFRIGERANTS NOT SPECIFIED BY TOSHIBA CARRIER CORPORATION

Toshiba Air Conditioning products are designed and manufactured on the assumption that each product is used with the specific refrigerant specified for that product.

The use of incorrect refrigerant may cause mechanical defects, malfunctions or failures which, in some cases, could result in a serious safety issue. For this reason Toshiba Carrier Corporation requires that only the specified refrigerant for a product should be used.

The type of refrigerant specified for a product is stated in the accompanying owners manual for a product, or on the label attached to the product itself.

Toshiba Carrier Corporation shall not assume any liability for failures, malfunctions or safety issues on any product if incorrect refrigerant is used in that product.

> TESTING CONDITIONS BASED ON EUROVENT REQUIREMENTS

Cooling mode

Indoor air temperature: 27°CDB / 19°CWB

Outdoor temperature: 35°CDB / 24°CWB

Heating mode

Indoor air temperature: 20°CDB

Outdoor temperature: 7°CDB / 6°CWB

Certified data accessible on Eurovent website

Seasonal data accessible on Toshiba Ecodesign website



Better Air Solutions

Through our commitment to world-class **efficiency**, versatile **scalability** and leading **quality**, Toshiba Air Conditioning advances leading-edge technologies to find the most forward-thinking solutions possible for your world.

